

# KENWOOD

GPS NAVIGATION SYSTEM

## DNX SERIES

DNX9260BT    DNX7260BT

MONITOR WITH DVD RECEIVER

## DDX SERIES

DDX8026BT

---

## INSTRUCTION MANUAL

Kenwood Corporation



# Contents

<b>Before Use</b>	<b>4</b>
<b>Notes</b>	<b>5</b>
<b>How to read this manual</b>	<b>10</b>
<b>Functions of the buttons on the front panel</b>	<b>12</b>

<b>Basic Operation</b>	<b>14</b>
How to Display Top Menu Screen	14
Customization of Top Menu Screen	15
How to play media	16
Detaching the monitor panel	17
Attaching the monitor panel	17
How to Display the Source Control Screen	18
Operation on the Playback Screen of Visual Sources	19
How to Display the Navigation Screen	20
Picture in Picture function	20
Secondary window function	21

<b>Watching DVD/Video CD</b>	<b>22</b>
Playback Screen	22
Easy Control Screen	22
Source Control Screen	23
DVD-VIDEO Disc Menu	24
Video CD Zoom Control	25
<b>Music CD/ Audio File Listening &amp; Video File/ Picture File Watching</b>	<b>26</b>
Source Control Screen	26
List Search	28
Album artwork (USB/SD)	29
Link search (Audio File in USB/SD)	30
Playback Screen (Video file, Picture file)	30
Easy Control Screen (Video file, Picture file)	31
Picture Control (USB/SD)	31
Movie Menu Control (Disc)	32

<b>Initial Setup</b>	<b>104</b>
----------------------	------------

<b>iPod Control</b>	<b>33</b>
Playback Screen	33
Easy Control Screen	33
Source Control Screen	34
iPod List	35
iPod Album Artwork	36
Link search (Music file)	36
<b>Radio Listening</b>	<b>37</b>
Source Control Screen	37
Preset Select	38
Auto Memory	38
Manual Memory	39
Radio Text	39
Traffic Information	40
Search by Program Type	40
<b>TV Watching</b>	<b>41</b>
Function During TV Screen	41
Easy Control Screen	41
Source Control Screen	42
TV Menu (only with KTC-D500E (optional accessory) connected)	43
Auto Memory	43
Manual Memory	44
Preset Select	44
<b>Bluetooth Audio Control</b>	<b>45</b>
Before Use	45
Source Control Screen	45
<b>Voice Control (DNX9260BT only)</b>	<b>46</b>
Voice Control	46
<b>Other Functions</b>	<b>48</b>
External Device Power Supply Control	48
Muting Audio Volume upon Reception of Phone Call	48
<b>Screen Control</b>	<b>49</b>
Screen Control	49

**Hands Free Unit Control 50**

Before Use	50
Downloading the Phonebook	50
Receiving a Call	50
During a Call	51
Call Waiting	51
Making a Call	51
Calling by Phonebook	52
Calling by Entering a Phone Number	53
Making a Call Using Call Records	54
Calling by Voice Recognition (DNX7/ DDX8 series)	54
Controlling Tone-based Services	56
Setting Up the Hands-Free Phone	56
Voice Registration (DNX7/ DDX8 series)	57
Key Word Voice Registration (DNX7/ DDX8 series)	58
Phone Number Preset	59
SMS (Short Message Service)	60

**Audio Control 62**

Audio Control Menu	62
Audio Control	62
Equalizer Control	63
Graphic Equalizer Setup	63
Zone Control	64
Space Enhancer (DNX7 series)	65
Listening Position	65
SRS WOW Control (DNX9/ DDX8 series)	66
Surround Control (DNX9/ DDX8 series)	67

**Remote Controller 96**

Battery installation	96
Remote Controller mode switch	96
Common operations (AUD mode)	97
DVD/VCD (DVD mode)	98
Music CD/Audio file/Video file/ Picture file (AUD mode)	100
iPod (AUD mode)	100
Radio (AUD mode)	101
Navigation (NAV mode)	102
TV (TV mode)	103

**Setup Menu 68**

How to Display SETUP Menu Screen	68
DivX Setup	69
Software Information	69
User Interface	70
Language Setting	70
Touch Panel Adjustment	71
Clock and Date Setup	72
Security Setup	72
Monitor Angle Control	73
EXT SW Setup	74
Setup Memory	75
Changing Background image	76
Panel Color Coordinate	77
Screen Control	78
Registering Bluetooth Unit	79
Registering Bluetooth Unit PIN Code	81
Bluetooth Unit Connection	81
Bluetooth Hands-Free/Audio Output Setup	82
AV Input Setup	82
AV Output Interface Setup	83
Camera Setup	83
Navigation Setup	84
DSP Bypass Control (DNX7 series)	85
Speaker Setup	86
Car Type (DTA) Setup	87
Channel Level (DNX9/ DDX8 series)	89
DVD Setup	90
DVD Language Setup	90
DVD Parental Level Setup	91
Disc Setup	92
USB/ SD Setup	93
iPod Setup	94
Tuner Setup	94
TV Setup	95

**Status bar Indicator items 105****DVD Language Codes 106****Help? Troubleshooting 107****Help? Error 108****Specifications 110**

## Before Use

### ▲WARNING

#### To prevent injury or fire, take the following precautions:

- To prevent a short circuit, never put or leave any metallic objects (such as coins or metal tools) inside the unit.
- Do not watch or fix your eyes on the unit's display when you are driving for any extended period.

#### How to reset your unit

- If the unit or the connected unit fails to operate properly, press the Reset button. The unit returns to factory settings when the Reset button is pressed.
- Remove the USB device before pressing the Reset button. Pressing the Reset button with the USB device installed can damage the data contained in the USB device. For how to remove the USB device, see <How to play media> (page 16).
- When the unit is turned on after pressing the Reset button, the Initial SETUP screen is displayed. Refer to <Initial Setup> (page 104).

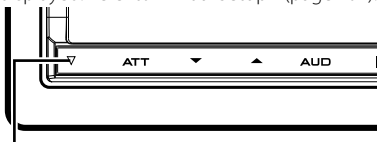

Reset button

#### Cleaning the Unit

If the faceplate of this unit is stained, wipe it with a dry soft cloth such as a silicon cloth. If the faceplate is stained badly, wipe the stain off with a cloth moistened with neutral cleaner, then wipe it again with a clean soft dry cloth.



- Applying spray cleaner directly to the unit may affect its mechanical parts. Wiping the faceplate with a hard cloth or using a volatile liquid such as thinner or alcohol may scratch the surface or erase characters.

#### About the Terminals of the Unit and Faceplate

- To prevent deterioration, do not touch the terminals of the unit and faceplate with your fingers.
- If the terminals on the unit or faceplate get dirty, wipe them with a clean soft dry cloth.

#### Lens Fogging

When you turn on the car heater in cold weather, dew or condensation may form on the lens in the disc player of the unit. Called lens fogging, this condensation on the lens may not allow discs to play. In such a situation, remove the disc and wait for the condensation to evaporate. If the unit still does not operate normally after a while, consult your Kenwood dealer.

#### Handling discs

- Do not touch the recording surface of the disc.
- Do not stick tape etc. on the disc, or use a disc with tape stuck on it.
- Do not use disc type accessories.
- Clean from the center of the disc and move outward.
- When removing discs from this unit, pull them out horizontally.
- If the disc center hole or outside rim has burrs, use the disc only after removing the burrs with a ballpoint pen etc.

#### Discs that cannot be used

- Discs that are not round cannot be used.

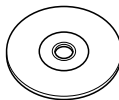

- Discs with coloring on the recording surface or discs that are dirty cannot be used.
- This unit can only play the CDs with



This unit may not correctly play discs which do not have the mark.

- You cannot play a disc that has not been finalized. (For the finalization process refer to your writing software, and your recorder instruction manual.)
- If you try to load a 3-inch-disc with its adapter into the unit, the adapter might separate from the disc and damage the unit.

### Other notes

- If you experience problems during installation, consult your Kenwood dealer.
- When you purchase optional accessories, check with your Kenwood dealer to make sure that they work with your model and in your area.
- Select a language used to display menus, audio file tags, etc. See <Language Setting> (page 70).
- The RDS or RBDS feature won't work where the service is not supported by any broadcasting station.

### Protecting the monitor

To protect the monitor from damage, do not operate the monitor using a ball point pen or similar tool with the sharp tip.

## Notes

### List of playable discs

Disc types	Support		Remark
	Standard		
DVD	DVD Video	○	
	DVD Audio	×	
	DVD-VR	×	
	DVD-R	○	MP3/WMA/AAC/MPEG1/MPEG2/DivX Playback
	DVD-RW	○	Multi-border/Multisession/(Playback depends on authoring conditions)
	DVD+R	○	Compatible with 8-cm (3 inch) discs
	DVD+RW	○	
	DVD-R DL (Dual layer)	○	
	DVD+R DL (Double layer)	○	Only video format
DVD-RAM	×		
CD	Music CD	○	CD-TEXT/8-cm (3 inch) discs supported.
	CD-ROM	○	MP3/WMA/AAC/DivX playback
	CD-R	○	Multisession supported
	CD-RW	○	Packet write not supported.
	DTS-CD	○	
	Video CD (VCD)	○	
	Super video CD	×	
	Photo CD	×	
	CD-EXTRA	△	Only music CD session can be played.
	HDCD	×	
CCCD	×		
Others	Dualdisc	×	
	Super audio CD	△	Only CD layer can be played.

○ : Playback is possible.

△ : Playback is partly possible.

× : Playback is impossible.



- When buying DRM enabled contents, check the Registration Code in the <DivX Setup> (page 69). Registration Code changes each time a file with the displayed Registration Code is played to protect against copying.

## Use of "DualDisc"

When playing a "DualDisc" on this unit, the surface of the disc that is not played may be scratched while the disc is inserted or ejected. Since the music CD surface does not conform to the CD standard, playback may be impossible.

(A "DualDisc" is a disc with one surface containing DVD standard signals and the other surface containing music CD signals.)

## About Audio files

### • Playable Audio file

AAC-LC (.m4a)

MP3 (.mp3)

WMA (.wma)

Linear PCM (WAVE) (.wav) \*1



\*1 Mass-storage-class USB device, SD/SDHC card only

• If music of normal CD and other playback systems are recorded in the same disc, only the playback system recorded at the first setout is played.

### • Acceptable media

CD-R/RW/ROM, DVD±R/RW, mass-storage-class USB device, SD/SDHC card, iPod with KCA-iP301V

### • Playable disc file format

ISO 9660 Level 1/2, Joliet, Romeo, Long file name.

### • Playable USB device or SD card file system

FAT16, FAT32

Although the audio files are complied with the standards listed above, the play maybe impossible depending on the types or conditions of media or device.

### • Playing order of the Audio file

In the example of folder/file tree shown below, the files are played in the order from ① to ⑩.

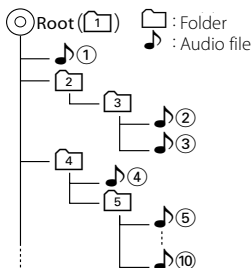

An online manual about audio files is put on the site, [www.kenwood.com/cs/ce/audiofile/](http://www.kenwood.com/cs/ce/audiofile/). On this online manual, detailed information and notes which are not written in this manual are provided. Make sure to read through the online manual as well.

## About Video files

### • Acceptable video files

MPEG1 (.mpg, .mpeg, .m1v)

MPEG2 (.mpg, .mpeg, .m2v)

DivX (.divx, .div, .avi) \*1

H.264/MPEG-4 AVC (.mp4, .m4v) \*2

WMV 9 (.wmv, .m2ts) \*2



\*1 CD-R/RW/ROM, DVD±R/RW only

\*2 Mass-storage-class USB device, SD/SDHC card only

### • Acceptable media

CD-R/RW/ROM, DVD±R/RW

Mass-storage-class USB device, SD/SDHC card

iPod with KCA-iP301V

Acceptable discs, disc formats, USB device or SD card file system, file and folder names and playing order are the same as those for audio files. See <About Audio files>.

## About Picture files

### • Acceptable picture files

JPEG (.jpg, .jpeg)  
PNG (.png)  
BMP (.bmp)

### • Acceptable media

Mass-storage-class USB device, SD/SDHC card

Acceptable discs, disc formats, USB device or SD card file system, file and folder names and playing order are the same as those for audio files. See <About Audio files>.

## iPod/iPhone that can be connected to this unit

Made for

- iPod nano (1st generation)
- iPod nano (2nd generation)
- iPod nano (3rd generation)
- iPod nano (4th generation)
- iPod nano (5th generation)
- iPod with video
- iPod classic
- iPod touch (1st generation)
- iPod touch (2nd generation)

Works with

- iPhone
- iPhone 3G
- iPhone 3GS



**iPhone**  
4GB 8GB 16GB



**iPhone 3G**  
8GB 16GB



**iPhone 3GS**  
16GB 32GB

- Update iPod/iPhone software to the latest version.
- You can control an iPod/iPhone from this unit by connecting an iPod/iPhone (commercial product) with Dock connector using an optional accessory iPod connection cable (KCA-iP301V). The word "iPod" appearing in this manual indicates the iPod/iPhone connected with the KCA-iP301V (optional accessory).
- By connecting your iPod/iPhone to this unit with an optional accessory iPod connection

cable (KCA-iP301V), you can supply power to your iPod/iPhone as well as charge it while playing music. However, the power of this unit must be on.



- If you start playback after connecting the iPod, the music that has been played by the iPod is played first. In this case, "RESUMING" is displayed without displaying a folder name, etc. Changing the browse item will display a correct title, etc.
- When the iPod is connected to this unit, "KENWOOD" or "✓" is displayed on the iPod to indicate that you cannot operate the iPod.

## About USB device

- In this manual, the word "USB device" is used for a flash memory device and digital audio players can be recognized as mass-storage.
- When the USB device is connected to this unit, it can be charged up provided that this unit is powered.
- Install the USB device in the place where it will not affect driving safely.
- You cannot connect a USB device via a USB hub and Multi Card Reader.
- Take backups of the audio files used with this unit. The files can be erased depending on the operating conditions of the USB device. We shall have no compensation for any damage arising from any erased data.
- No USB device comes with this unit. You need to purchase a commercially available USB device.
- When connecting the USB device, usage of the CA-U1EX (option) is recommended. Normal playback is not guaranteed when a cable other than the USB compatible cable is used. Connecting a cable whose total length is longer than 5 m can result in abnormal playback.

**Next page ►**

### About SD card (DDX series only)

- This unit is capable of playback of SD/SDHC memory cards complying with the SD or SDHC standard.
- A special adapter is required to use a miniSD card, miniSDHC card, microSD card or microSDHC card.
- The MultiMedia Card (MMC) cannot be used.

### Navigation units that can be connected to this unit (DDX series only)

- KNA-G620T
- Update the navigation software to the latest version. For how to update the software, refer to the instruction manual of the navigation unit.  
For the latest information on connectable navigation units, access [www.kenwood.com/cs/ce/](http://www.kenwood.com/cs/ce/).

### TV tuner that can be connected to this unit

Digital TV tuner

- KTC-D500E

Analog TV tuner

- KTC-V301E
- KTC-V300E

### About the Cell-Phone

This unit conforms to the following Bluetooth specifications:

<b>Version</b>	Bluetooth Standard Ver. 2.1 + EDR
<b>Profile</b>	HFP (Hands Free Profile) OPP (Object Push Profile) PBAP (Phonebook Access Profile) SYNC (Synchronization Profile)

For the cell-phones verified for compatibility, access the following URL:

<http://www.kenwood.com/cs/ce/bt/>



- The units supporting the Bluetooth function have been certified for conformity with the Bluetooth Standard following the procedure prescribed by Bluetooth SIG. However, it may be impossible for such units to communicate with your cell-phone depending on its type.
- HFP is a profile used to make a hands-free call.
- OPP is a profile used to transfer data such as a phone book between units.

### About the Bluetooth Audio player

This unit conforms to the following Bluetooth specifications:

<b>Version</b>	Bluetooth Standard Ver. 2.1 + EDR
<b>Profile</b>	A2DP (Advanced Audio Distribution Profile) AVRCP (Audio/Video Remote Control Profile)



- A2DP is a profile designed to transfer the music from an audio player.
- AVRCP is a profile designed to control playback and selection of music by an audio player.



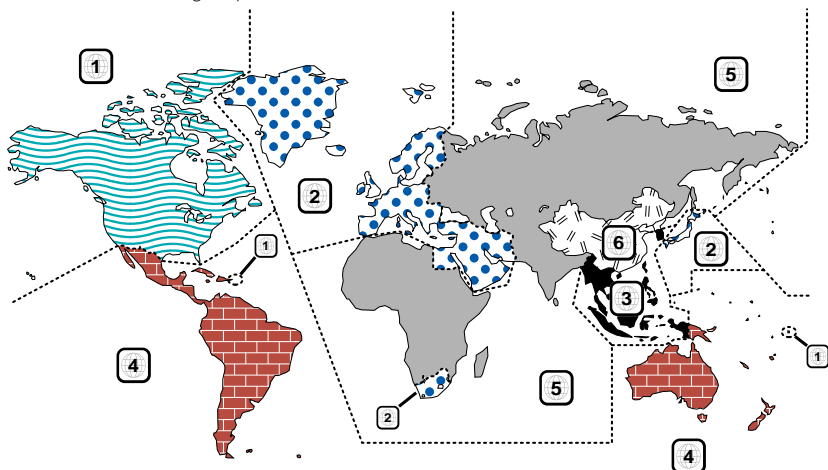

## Region codes in the world

The DVD players are given a region code according to the country or area it is marketed, as shown in the following map.



## DVD disc marks

Symbol	Description
	Indicates a region number. The discs with this mark can be played with any DVD player.
	Indicates the number of audio languages recorded. Up to 8 languages can be recorded in a movie. You can select a favorite language.
	Indicates the number of subtitled languages recorded. Up to 32 languages can be recorded.
	If a DVD disc has scenes shot from multiple angles, you can select a favorite angle.
	Indicates the type of screen for the image. The left mark indicates that a wide image picture (16:9) is displayed on a standard TV set screen (4:3) with a black band at both the top and bottom of the screen (letter box).

## Operation regulatory marks

With this DVD, some functions of this unit such as the play function may be restricted depending on the location where the DVD is playing. In this case, the following marks will appear on the screen. For more information, refer to the disc manual.



## Discs with limited period of use

Do not leave discs with a limited period of use in this unit. If you load an already expired disc, you may not be able to remove it from this unit.

# How to read this manual

This manual uses illustrations to explain its operations.

The displays and panels shown in this manual are examples used to provide clear explanations of the operations. For this reason, they may be different from the actual displays or panels used, or some display patterns may be different.

## Selecting a screen item

Select and choose an item on the screen.  
Select the item by touching the button on the screen.

## Short Press

Press the button, denoted by .

## Change in the screen

With each operation, the screen changes in the order shown here.

▼ : Continues to the next line.  
● : Ends here.

## Continue to the next page

The instruction continues to the next page.  
Make sure to flip the page for the rest of the instruction.

### Source Control Screen

Switches to the source control screen to use various playback functions.

#### 1 Display the Source Control Screen

See <How to Display the Source Control Screen> (page 27).

#### 2 Operation on the Source Control screen



▶|| AutoFile Plays or pauses.  
Dragging [▶||] left or right changes the playing position.

#### Multi Function



[SEEK] Switches the Seek mode.  
The mode is switched in the following order each time you touch the button.

Display	Setting
"AUTO1"	Tunes in a station with good reception automatically.
"AUTO2"	Tunes in stations in memory one after another.
"MANU"	Switches to the next frequency manually.





Continue to touch until the memory number appears.

Next page ▶

The above operation example with the mark differs from the actual operation.

## Drag or Flick operation

Press the button, denoted by . It indicates that you scroll icons or list items left and right by flicking or dragging them and touch to select the desired one.

The right mark indicates that they can be scrolled up and down. 

## Function Icon

Icons representing available functions are shown below.

 DVD-VIDEO: Function of DVD-VIDEO playback.

 Video CD: Function of Video CD playback.

 CD: Function of CD (CD-DA) playback.

 Audio File: Function of Audio File playback.

 MPEG: Function of MPEG file playback.

 DivX: Function of DivX file playback.

 JPEG: Function of JPEG file playback.

 Disc: Function of Disc (DVD, CD) media.

 USB SD: Function of USB device or SD card.

 FM: Function of FM reception.

## Press 2 seconds or more

Press the button, denoted by  for 2 seconds or more.

Indicates to press and hold down the button until operation starts or the screen changes.

The left example indicates to press the button for 2 seconds.

## About the model groups

If different functions are used in different model groups, the model groups are described as shown below. Names of series included in each model group are as follows:

### DNX series

DNX9260BT, DNX7260BT

### DDX series

DDX8026BT

## Other marks



Important precautions are described to prevent injuries etc.



Special instructions, supplementary explanations, limitations, and reference pages are described.



General precautions and reference pages are shown on the item.



The initial value of each setup is shown.

## Functions of the buttons on the front panel

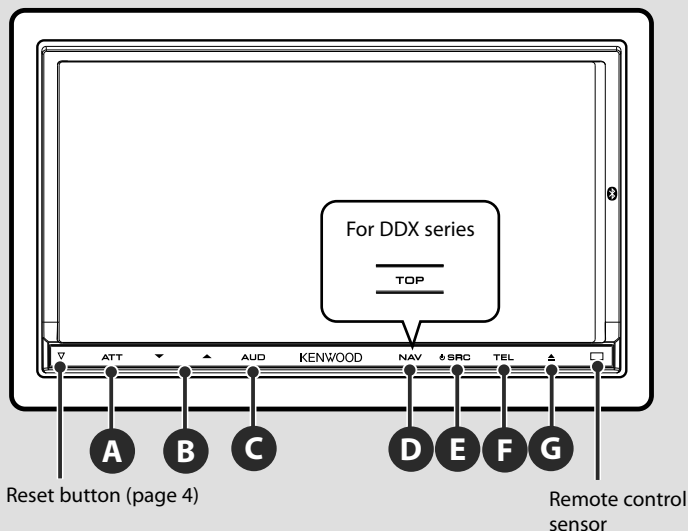

**1 sec.** : Press for longer than 1 second

**A** Attenuation of the volume On/Off.

**1 sec.** Switches the source that is output at the AV OUTPUT terminal.

**B** Volume adjustment.

**C** Displays Graphic Equalizer screen. \*<sup>1</sup> (page 63)

**1 sec.** Turns the display Off. \*<sup>2</sup>

**D** ***DNX series and DDX series with navigation unit***

Displays the navigation screen.

When the navigation screen has already been displayed, it switches to the navigation screen with Split Screen Control window.

**1 sec.** While watching the navigation screen

Picture in Picture function On/Off. \*<sup>3</sup> (page 20)

***DDX series without navigation unit***

Displays the Top Menu screen. (page 14)

- E** Turns the power On. \*5  
 Displays the Source Control screen. (page 18)  
 In case of visual sources, the playback screen is first displayed and changed to the source control screen by pressing the button again.  
**1 sec.** Turns the power Off.
- 
- F** Displays the Hands Free Control screen.  
**1 sec.** While watching the Source Control screen  
 Secondary window function On/Off. \*4 (page 21)  
**1 sec.** While watching the navigation screen  
 Displays the Screen Control screen. (page 49)  
**1 sec.** While watching the playback screen of a visual source  
 Displays the Easy Control screen.
- 
- G** Opens the panel and ejects the disc.  
 Closes the panel.  
**1 sec.** Opens the panel fully.

### Detaching the front panel

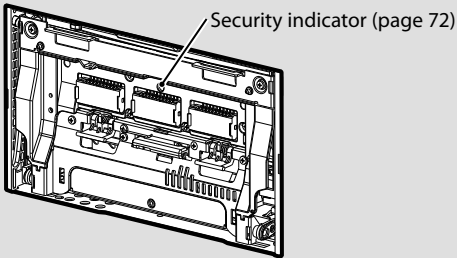

- \*1 The display may not switch to Graphic Equalizer screen in some conditions.  
 \*2 The function of the [AUD] button can be changed to camera view function. See <User Interface> (page 70).  
 \*3 When the Secondary window function (page 21) is activated, this function is disabled.  
 \*4 When the Picture in Picture function (page 20) is activated, this function is disabled.  
 \*5 When the unit is powered off, pressing any one of **D**, **E** and **F** turns it on.

# Basic Operation

## How to Display Top Menu Screen

Top Menu Screen is the entrance to all the functions. You can select sources and various setup menus from this screen.

### Top Menu screen



### How to display the Top Menu screen **DNX series and DDX series with navigation unit**

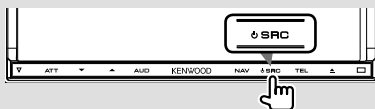

When a video screen is displayed



Touch the [MENU] button on any screen.

The **Top Menu Screen** appears.



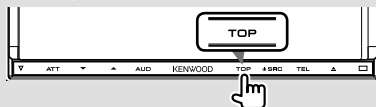

### **DDX series without navigation unit**



The **Top Menu Screen** appears.

### **Buttons on the Top Menu screen**

For how to operate each source or setup, see the following pages.



- [  ] DVD-VIDEO/ Video CD disc (page 22)
- [  ] CD disc (page 26)
- [  ] Audio file/ Video file disc (page 26)
- [  ] iPod (page 33)
- [  ] USB (page 26)
- [  ] SD (page 26) (DDX series only)
- [  ] TUNER (page 37)
- [  ] TV (page 41)
- [  ] Bluetooth Audio (page 45)
- [  ] Video
- [  ] Standby

- \*1 Displays Tools screen of navigation.
- \*1 Displays Where To ? screen of navigation.
-  Switches to the navigation screen.
-  Switches to the Hands Free Main screen.
- \*1 Displays Navigation Settings screen.
-  Displays SETUP Menu screen. (page 68)
-  Displays Hands Free SETUP screen. (page 79)
-  Displays Audio Control Menu screen. (page 62)
-  Displays the EXT SW (External Switch) Control screen. (page 48)
-  Changes the screen skin each time it is pressed. (DNX9/ DDX series only)



- \*1 Instruction manual of the Navigation part. (DNX series and DDX series with navigation unit only)
- For Disc media, iPod, USB and SD, the input is switched to the source as the media or the device is set.

The buttons listed below are common for many screens.

- [MENU]** Displays Top Menu screen.
-  Opens the function bar. The buttons shown below appear.
  -  Displays the currently selected source screen.
  -  Displays Audio Control Menu screen. (page 62)
  -  Displays SETUP Menu screen. (page 68)
  -  Displays the EXT SW (External Switch) Control screen. (page 48)

-  Closes the function bar.

## Customization of Top Menu Screen

Up to 3 sources or setups frequently used on the Top Menu screen can be registered.

### 1 Display the icon you want to register



Scroll icons left or right by flicking or dragging to display the desired icon.

### 2 Register the icon

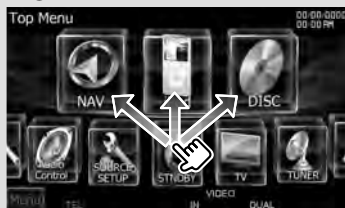

Drag the icon to the desired place.

### How to play media

#### ■ Disc media

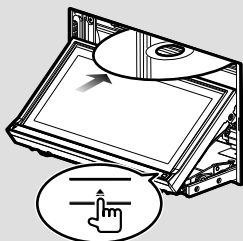

Press the [▲] button to open/close the front panel.

If a disc is already inserted, it is ejected by pressing the [▲] button.

#### ■ iPod

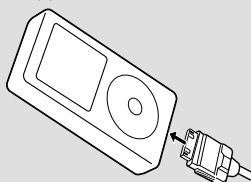

To disconnect the iPod, stop the playback by touching the [▲] button on the source control screen, and then disconnect the iPod. See <Source Control Screen> (page 34).

#### ■ USB device

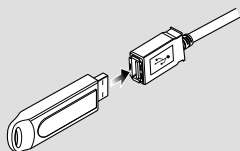

To disconnect the USB device, touch the [▲] button on the source control screen, and then disconnect the USB device. See <Source Control Screen> (page 26).

#### ■ SD card

For DNX series:

Update the navigation software.

For DDX series:

Audio File Listening & Video File/  
Picture File Watching

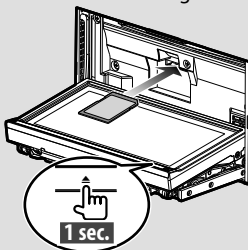

Press the [▲] button for longer than 1 second to open the front panel.

#### *Inserting the SD card*

Hold the SD card with the label side up and the notched section on the right, and insert it into the slot until it clicks.

#### *Removing the SD card*

Push the SD card until it clicks and then remove your finger from the card. The card pops up so that you can pull it out with your fingers.

Press the [▲] button to close the front panel.



- For DNX series:  
For how to update the software, refer to the instruction manual of the navigation unit.
- For DDX series:  
After inserting the SD card, select the SD source on the Source Select screen.



- The playback starts automatically after loading the media or connecting the device.



## Detaching the monitor panel

### 1 Open the front panel

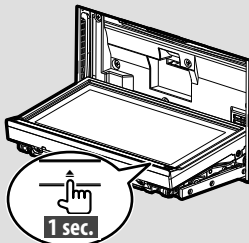

Press the [**▲**] button for longer than 1 second to open the front panel before turning the ignition off.



- You can set the front panel to open automatically when the ignition is turned off. Refer to <Monitor Angle Control> (page 73).

### 2 Detach the monitor panel

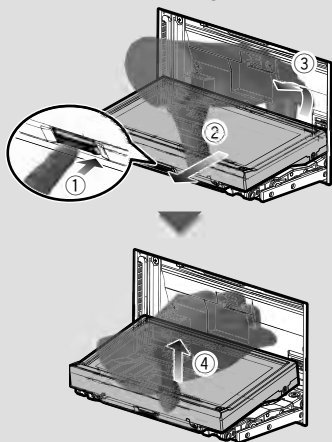

- The attaching plate closes automatically about 10 seconds after the monitor panel is released. Remove the monitor panel before this happens.

- It closes automatically when no operation is done for about a minute.

### 3 Put the monitor panel in the protective bag

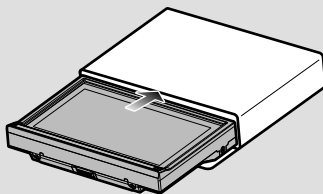

## Attaching the monitor panel

Hold the monitor panel securely so as not to drop it accidentally.

Fit the monitor panel onto the attaching plate until it is firmly locked.

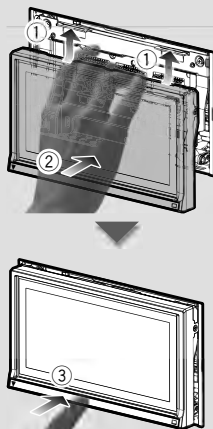

## How to Display the Source Control Screen

On the Source Control screen you can find all the control buttons for the selected source.

### Source Control Screen



- For how to use each button, see the operation pages of each source.

### How to display the Source Control screen

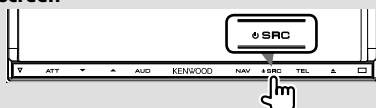

When a video screen is displayed



The **Source Control Screen** appears.

### While watching the navigation screen with secondary window



The **Source Control Screen** appears.



- The screen will return to the navigation screen by touching the same part of the Source Control screen.

### While watching the Easy Control Screen



The **Source Control Screen** appears.

## Operation on the Playback Screen of Visual Sources

While watching visual sources, basic operation is possible by touching the screen.

The screen has 4 function areas. The function of each area is different depending on the sources. (Some areas are unavailable for some sources.)

### Playback screen of a visual source

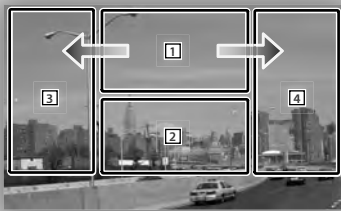

#### Basic operation of each area

- 1 Displays Menu control screen (DVD-VIDEO source), Picture control buttons (sources with picture files), or Zoom control buttons (Video CD). Switches TV band.
  - 2 Displays Easy Control Screen. \*1
  - 3 Reverse search.
  - 4 Forward search.
- Fast Forwards when flicked from 1 to 4.
- ← Fast Backwards when flicked from 1 to 3.



- For the function of each touch control area, see the pages of each source.

#### How to display the playback screen

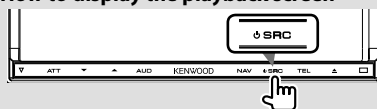

The **Playback screen of a visual source** appears.

#### While watching the Source Control Screen



The **Playback screen of a visual source** appears.

#### \*1 Easy Control Screen



#### Buttons on the Easy Control Screen

- [▼] Changes the function as follows by touching the [▼] button.
- [SCRN] Displays Screen Control screen (page 49).
- [TEL] Switches to the Hands Free Main screen (page 51).
- [EXT SW] Switches to the EXT SW Control screen (page 48).
- [◀◀], [▶▶], [◀◀], [▶▶], [■], [▶▶] Buttons for source control. The buttons are different depending on the source. See the operation pages of each source.

## How to Display the Navigation Screen

### DNX series

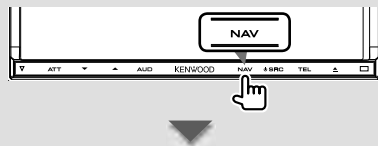

The navigation screen appears.

### DDX series with navigation unit

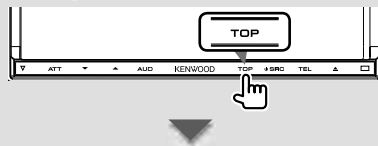

The navigation screen appears.



- For how to set up and use the navigation function, see the Navigation Instruction Manual.



- For DDX series, an optional navigation system needs to be connected. See <Navigation units that can be connected to this unit> (page 8) for connectable navigation units.

## Picture in Picture function

Two screens, the navigation screen and source screen, are displayed. When Picture in Picture function is on, touching the source screen switches between the camera image and source image.

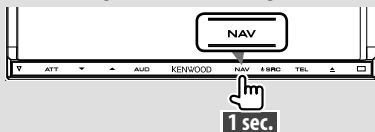

Pressing the button for longer than 1 second while the navigation screen is displayed switches the Picture in Picture function on/off.

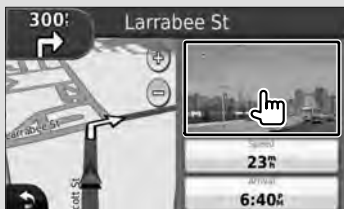

The screen switches between visual source's playback screen and camera view screen each time the small window is touched.

## Secondary window function

You can control audio sources while the navigation screen is displayed, and view the navigation information while the source control screen is displayed.

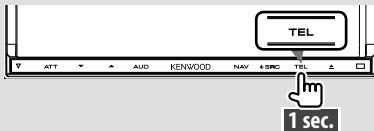

Pressing the button for longer than 1 second while the source control screen is displayed switches the secondary window function on/off.

## Source Control screen with navigation window



Displays the navigation screen with Secondary window.

## Navigation screen with Information window



Displays the Source Control screen with navigation window.

## Navigation screen with Easy Control window



## Navigation screen with Split Screen Control window



## Buttons on the Secondary window

- [] Displays the navigation screen with Information window.
- [] Displays the navigation screen with Easy Control window.
- [] Displays the navigation screen with Split Screen Control window.
- [] Displays the currently selected source screen.

The button icon to be displayed varies depending on playing source. The above icon display is an example when the source is DVD.

- [MENU] Displays the Top Menu screen.

# Watching DVD/Video CD

You can play DVD/Video CD using various functions.



- Set the remote controller mode switch to "DVD" mode before starting operation, see <Remote Controller mode switch> (page 96).

## Playback Screen

Basic functions are available even when the playback screen is displayed.

### 1 Display the Playback Screen

See <Operation on the Playback Screen of Visual Sources> (page 19).

### 2 Operation on the Playback Screen

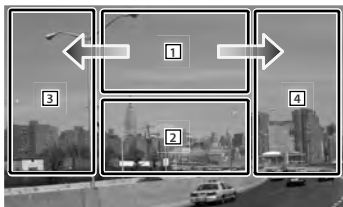

- 1** **DVD-VIDEO** Displays the Menu Control Screen or Highlight Control (When DVD Menu) (page 24).

**Video CD** Displays the Zoom Control Screen (page 25).

Touching this area during fast forwarding or fast backwinding plays a source.

- 2** Displays Easy Control Screen.

Touching this area during fast forwarding or fast backwinding plays a source.

- 3, 4** **DVD-VIDEO** Searches for a chapter.  
 **Video CD** Selects a scene (when PBC is On) or a track (when PBC is Off).

➡ Fast Forwards.

⬅ Fast Backwards.

## Easy Control Screen

Displays the basic operation buttons on the screen.

### 1 Display the Easy Control Screen



### 2 Operation on the Easy Control Screen

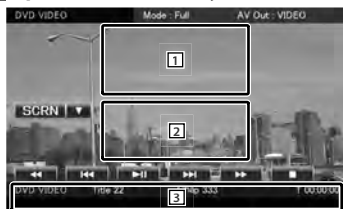

- 1, 2** Switches to the Playback Screen.

- 3** Displays the Source Control Screen.

[<<<], [>>>] Fast Forwards or Fast Backwards. Changes the speed (2 times, 3 times, or off) each time the button is touched.

[<<<], [>>>]

**DVD-VIDEO** Searches for a chapter.

**Video CD** Selects a scene (when PBC is On) or a track (when PBC is Off).

Stops playing.

When touched twice, the disc is played from its beginning when you play it the next time.

Plays or pauses.

## Source Control Screen

Switches to the source control screen to use various playback functions.

### 1 Display the Source Control Screen

See <How to Display the Source Control Screen> (page 18).

### 2 Operation on the Source Control Screen



[▶||] Plays or pauses.

[■] Stops playing.

When touched twice, the disc is played from its beginning when you play it the next time.

[▲] Ejects a disc.

[◀◀], [▶▶] Fast Forwards or Fast Backwards. Changes the speed (2 times, 3 times, or off) each time the button is touched.

[◀◀], [▶▶]

**DVD-VIDEO** Searches for a chapter.

**Video CD** Selects a scene (when PBC is On) or a track (when PBC is Off).

[◀|], [|▶] **DVD-VIDEO** Slow Forwards or Backwards.

[◀] Switches to the playback screen.

[1] Information display  
Volume Label.

"Title" Title Number Display

"Chap" Chapter Number Display

"Scene"/"Track" Scene/Track Number Display

"▶" Play Mode Display

"T"/"C"/"R"/"P" Play Time Display  
Use the [TIME] to change play time display.

[◀◀] When ◀◀ appears, the text display is scrolled by touching it.

## Multi Function



[X] Closes the multi function bar.

**DVD-VIDEO**

[TREP] Switches the Repeat Play operations in the following sequence.  
Title Repeat, Repeat Off

[CREP] Switches the Repeat Play operations in the following sequence.  
Chapter Repeat, Repeat Off

[TIME] Switches the play time display in the following sequence.  
Chapter ("C"), Title ("T"), remaining titles ("R")



### Video CD

**[REP]** Switches the Repeat Play operations in the following sequence. Track Repeat, Repeat Off (Available when the PBC is off)

**[TIME]** Switches the play time display in the following sequence. Track ("P"), remaining discs ("R") (Effective only when the PBC function is off)

**[PBC]** Turns the PBC On or Off. (only when VCD Ver 2.0 is in use)

## DVD-VIDEO Disc Menu

Selects an option from the DVD-VIDEO Disc Menu.

### 1 Display the Playback Screen

See <Operation on the Playback Screen of Visual Sources> (page 19).

### 2 Display the Menu Control 1 screen



### 3 Operation on the Menu Control 1 screen



**[Menu]** Calls the Menu.

**[Next]** Displays the Menu Control 2 screen.

**[<], [>], [▲], [▼]** Selects a menu option.

**[Enter]** Enters your menu selection.

**[Return]** Returns to the previous menu screen.

**[Top]** Displays the Top Menu.

**[Highlight]** Highlight Control.

**[Exit]** Exits the Menu Control 1 screen.

### 4 Operation on the Highlight Control

Highlight control lets you control DVD Menu by touching the menu button directly on the screen.



- To cancel Highlight Control, press the [TEL] button for longer than 1 second.
- The Highlight Control is cleared automatically after approximately 10 seconds.

### 5 Operation on the Menu Control 2 screen





**[Previous]** Displays the Menu Control 1 screen.

**[Angle]** Switches the picture angle.

**[SUB]** Switches the subtitle language.

**[Audio]** Switches the voice language.

**[Zoom]** Displays the Zoom Control screen.

**[Exit]** Exits the Menu Control 2 screen.

## 6 Operation on the Zoom Control screen



**[Zoom]** Changes the zoom ratio at 4 levels (2 times, 3 times, 4 times, or off) each time you touch.

**[◀], [▶], [▲], [▼]** Scrolls the screen in the direction you touch.

**[Return]** Returns to the Menu Control 2 screen.

**[Exit]** Exits the Zoom Control screen.

## Video CD Zoom Control

Displays an enlarged VCD screen.

### 1 Display the playback screen

See <Operation on the Playback Screen of Visual Sources> (page 19).

### 2 Display the Zoom Control screen



### 3 Operation on the Zoom Control screen



**[Zoom]** Changes the zoom ratio at 2 levels (2 times or off) each time you touch.

**[◀], [▶], [▲], [▼]** Scrolls the screen in the direction you touch.

**[Exit]** Exits the Zoom Control screen.

# Music CD/ Audio File Listening & Video File/ Picture File Watching

You can recall various control screens during playback of CD, audio file, video file and picture file.



- See <List of playable discs> (page 5) for playable discs.
- See <About Audio files> (page 6), <About Video files> (page 6) or <About Picture files> (page 7) for playable files.

## Source Control Screen

Switches to the source control screen to use various playback functions.

### 1 Display the Source Control Screen

See <How to Display the Source Control Screen> (page 18).

### 2 Operation on the Source Control screen



Plays or pauses.

Fast Forwards or Fast Backwards.

Selects a folder.

Stops playing.  
When touched twice, the disc is played from its beginning when you play it the next time.

Ejects the disc.

Removes the USB device/ SD card.

When "No Device" is shown, the USB device/ SD card can be removed safely.

If you wish to play it again while the USB device is connected, touch it again.

Selects a track/ file.

**[Slideshow]** in

Displays images in the folder currently being played one after another.

If there is no image in the folder currently being played, initial background is displayed.

**2** Displays the folder list. See <List Search> (page 28).

Displays the music list, video list, picture list, folder list or link list. See <List Search> (page 28).

**3** Displays the album artwork. See <Album artwork> (page 29).

Switches to the playback screen.

**1** Information display

Selects the Disc Text, title or artist.

Selects Folder Name, File Name, Title, Artist Name, Album Name, Year\*<sup>1</sup>, Genre\*<sup>1</sup>, Track\*<sup>1</sup>, or Comment\*<sup>1</sup>.  
(\*<sup>1</sup> USB/SD only)

"Track" Track Number Display

"" Folder Number Display

"" File Number Display

"#### / ####" Total number of file in the folder and the file number display

"▶" Play Mode Display  
"P"/ "R" Play Time Display

Use the [TIME] to change play time display.

[◀▶] When ◀▶ appears, the text display is scrolled by touching it.

### Slider control

Use the [CTRL]/ [Slider] to change the control mode.



[▶||] Plays or pauses.  
Dragging [▶||] left or right changes the playing position.

### Multi Function



[1/2] Switches the multi function display.

[✕] Closes the multi function bar.



[REP] Repeats the present track.

[RDM] Starts or stops Random Play (to play music in random order). Not available if there are only picture files.

[TIME] Switches the play time display between Track ("P"), and Disc Remaining Time ("R").

[INFO] Displays music information of CD-TEXT being played.





[4Line]/ [2Line] Switches the number of lines displayed in the Information Display.

[REP] Repeats the present file or data.

[PREP] Repeats the music or data of the present folder.

[RDM] Starts or stops Random Play (to play files of the present folder in random order).

[INFO]  Displays music information (such as Tag) of Audio file being played.

  Displays information of file being played.



[CTRL]/ [Slider]  Switches control mode to button/slider.

[Music]  Displays the music list.

[Video]  Displays the video list.

[Picture]  Displays the Thumbnail Viewer.

[Folder]  Displays the folder list.

[Link]  in  Searches for another song of the currently selected artist. See <List Search> (page 28).

## List Search

**Folder list:** Searches folders and Audio/ Video/ Picture files stored in media and devices according to hierarchy.

**Play list:** Lists and searches music contained in the USB device or SD card.

### 1 Display the Source Control Screen

See <Source Control Screen> (page 26).

### 2 Start List Search



- Touching 1 displays the previously used music list, video list, picture list, folder list or link list.

### 3 Select a file



1 Folder opens when touched, and the files in the folder are played.

2 Selects the file type to display.

3 Returns to the Source Control screen.

[◀] When ◀ appears, the text display is scrolled by touching it.

[📁 ROOT] Moves to the top hierarchy level.

[📁 TOP] Moves to the top folder.

[📁 UP] Moves up a hierarchy level.

[▶ CUR] Displays the currently playing folder.

[📁 OPEN] Plays songs in the folder and changes the display.

### Music or video list



1 Switches to the lower level of the category.

2 Returns to the Source Control screen.

[◀] When ◀ appears, the text display is scrolled by touching it.

[▶ ALL] Lists all the music in the selected category.

[📁 TOP] Moves to the top category.

[📁 UP] Moves to the upper level of the category.

[▶ CUR] Displays the currently playing category.

[↶] Returns to the previous screen.

## Thumbnail Viewer USB/SD



- 1 Touching a thumbnail image displays it in full-screen view.
  - 2 Returns to the Source Control screen.
- [  CUR ] Displays the currently playing folder.

## Scrolls to the position of the specified character



Scrolls to the selected character.

## Album artwork (USB/SD)

Searches for songs in an album artwork in USB/SD.

### 1 Display the Source Control Screen

See <Source Control Screen> (page 26).

### 2 Display the artwork Screen



### 3 Select an artwork

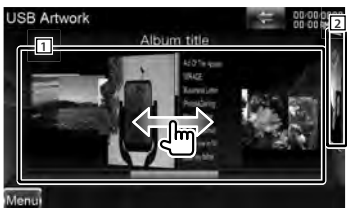

- 1 Touching an album artwork plays the first song in the album.
- 2 Returns to the Source Control screen.

## Link search (Audio File in USB/SD)

Searches for another song of the currently selected artist.

### 1 Display the Source Control Screen

See <Source Control Screen> (page 26).

### 2 Start Link search

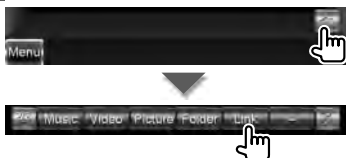

### 3 Select a song



- 1 Plays the touched song.
  - 2 Returns to the Source Control screen.
- [◀] When ◀ appears, the text display is scrolled by touching it.
- [CUR] Displays the currently playing folder.

### Scrolls to the position of the specified character



Scrolls to the selected character.

## Playback Screen (Video file, Picture file)

Basic functions are available even when the playback screen is displayed.

### 1 Display the Playback Screen

See <Operation on the Playback Screen of Visual Sources> (page 19).

### 2 Operation on the Playback Screen

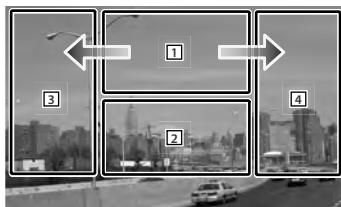

- 1 in Displays the Picture Control Screen (page 31).
- in Displays the Menu Control Screen (page 32).  
Touching this area during fast forwarding or fast backward plays a source.
- 2 Displays Easy Control Screen.  
Touching this area during fast forwarding or fast backward plays a source.
- 3, 4 Searches for a file.



- Touching these areas during the slide show of picture files searches for audio files.

➔ Fast Forwards.

➔ Fast Backwards.

## Easy Control Screen (Video file, Picture file)

Displays the basic operation buttons on the screen.

### 1 Display the Easy Control Screen



### 2 Operation on the Easy Control Screen

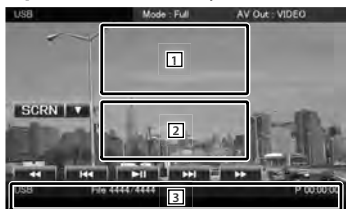

[1], [2] Switches to the Playback Screen.

Touching this area during fast forwarding or fast backwarding plays a source.

[3] Displays the Source Control Screen.

[<<<], [>>>] MPEG/DVX Fast Forwards or Fast Backwards.

[<<<], [>>>] Searches for a file. During the slide show of picture files, touching the buttons searches the audio file.

[■] [Disc] Stops playing.

[▶||] Plays or pauses.

## Picture Control (USB/SD)

Adjusting the picture display.

### 1 Display the Playback Screen

See <Operation on the Playback Screen of Visual Sources> (page 19).

### 2 Display the Picture Control Screen



### 3 Adjust the picture display



[↑ ↓] Reverses the picture horizontally.

[↶] Rotates counter clockwise.

[↷] Rotates clockwise.

[Exit] Ends Picture Control.

## Movie Menu Control (Disc)

Selects an option from the Movie Menu.

### 1 Display the playback screen

See <Operation on the Playback Screen of Visual Sources> (page 19).

### 2 Display the Menu Control screen



### 3 Operation on the Menu Control screen



**[SUB]** Switches the subtitle language.

**[Audio]** Switches the voice language.

**[Exit]** Exits the Menu Control screen.



# iPod Control

You can control and listen to songs in your iPod by connecting an iPod to this unit with KCA-iP301V (optional accessory). You can also display video contents on this unit when connecting an iPod with video.

## Playback Screen

Basic functions are available even when the playback screen is displayed.

### 1 Display the Playback Screen

See <Operation on the Playback Screen of Visual Sources> (page 19).

### 2 Operation on the Playback Screen

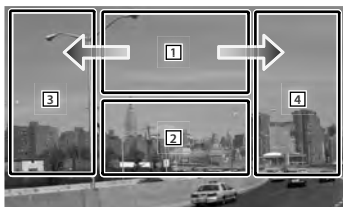

#### 1 Not effective

Touching this area during fast forwarding or fast backwarding plays a source.

#### 2 Displays Easy Control Screen.

#### 3, 4 Selects the music/video.

➡ Fast Forwards.

⬅ Fast Backwards.



- Remove all accessories such as headphone before connecting an iPod. You may not be able to control the iPod if you connect it with accessories attached.
- When you connect an iPod to this unit, playback starts from the song you were playing on the iPod itself (Resume Function).
- If the played song is not a video content, "No Video Signal" is displayed on the video screen.

## Easy Control Screen

Displays the basic operation buttons on the screen.

### 1 Display the Easy Control Screen



### 2 Operation on the Easy Control Screen

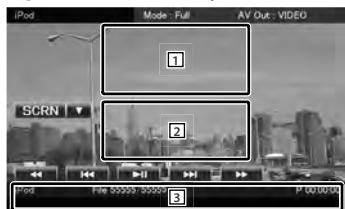

#### 1, 2 Switches to the Playback Screen.

#### 3 Displays the Source Control Screen.

[◀◀], [▶▶] Fast Forwards or Fast Backwards.

[◀◀◀], [▶▶▶] Music/Video Search.

[▶||] Plays or pauses.

## Source Control Screen

Switches to the source control screen to use various playback functions.

### 1 Display the Source Control Screen

See <How to Display the Source Control Screen> (page 18).

### 2 Operation on the Source Control Screen



[▶||] Plays or pauses.

[◀◀], [▶▶] Fast Forwards or Fast Backwards.

[◀◀], [▶▶] Selects Next or Previous Music/Video.

2 Displays the iPod list. See <iPod List> (page 35).

3 Displays the iPod artwork. See <iPod Album Artwork> (page 36).

Switches to the playback screen.

1 Information display  
Selects the Title, Artist Name, Album Name or iPod Name.

"##### / #####" Total number of music in the iPod and the music number display

"▶" Play Mode Display

"P" Play Time Display

[◀] When ◀ appears, the text display is scrolled by touching it.

### Slider control Music

Use the [CTRL]/ [Slider] to change the control mode.



[▶||] Plays or pauses.

Dragging [▶||] left or right changes the playing position.

## Multi Function

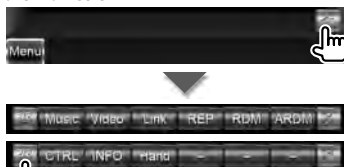

[1/2] Switches the multi function display.

Closes the multi function bar.

[MUSIC] Displays the list of music category.

[VIDEO] Displays the list of video category.

[Link]\*1 Searches for another song of the currently selected artist. See <Link search> (page 36).

[REP] Repeats the present file or data.

[RDM]\*1 Starts or stops Random play.

[ARDM]\*1 Starts or stops Album Random Play (plays randomly from current album).

[CTRL]/ [Slider] Switches control mode to button/slider.

[INFO] Displays the information screen of music/video being played.

[Hand] Allows you to operate iPod with the control of the iPod.



- \*1 Disabled when VIDEO is being played.
- [Hand]
    - In the iPod Control by Hand Mode, iPod cannot be operated using this unit.
    - This mode is not compatible with music information display.
    - iPod can be operated when it conforms to the iPod control function.

## iPod List

Lists and searches music/video contained in the iPod.

### 1 Display the Source Control Screen

See <Source Control Screen> (page 34).

### 2 Display the iPod List



- Touching 1 displays the previously used music list, video list, or link list.

### 3 Select music/video



- 1 Categories and music are listed. Touch a category name to view its contents. If music title is displayed, the music is played by touching it.

- 2 Returns to the Source Control screen.

[◀] When ◀ appears, the text display is scrolled by touching it.

[▶ ALL] Lists all the music in the selected category.

[▶ TOP] Moves to the top category.

[▶ UP] Returns to previous category.

[▶ CUR] Displays the currently playing category.

### Scrolls to the position of the specified character



Scrolls to the selected character.

## iPod Album Artwork

Searches for songs in an album artwork in iPod.

### 1 Display the Source Control Screen

See <Source Control Screen> (page 34).

### 2 Display the iPod artwork Screen

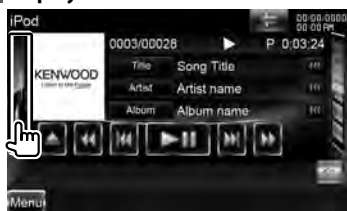

### 3 Select album

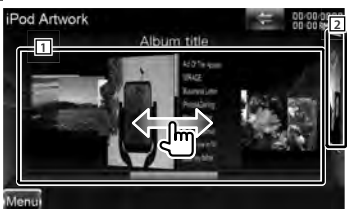

- 1 Touching an album artwork twice plays the first song in the album.
- 2 Returns to the Source Control screen.

## Link search (Music file)

Searches for another song of the currently selected artist.

### 1 Display the Source Control Screen

See <Source Control Screen> (page 34).

### 2 Start Link search



### 3 Select a song



- 1 Plays the touched song.
  - 2 Returns to the Source Control screen.
- [◀◀] When ◀◀ appears, the text display is scrolled by touching it.
- [▶▶ ALL] Lists all the music in the selected category.
- [▶▶ TOP] Moves to the top category.
- [▶▶ UP] Returns to previous category.
- [▶▶ CUR] Displays the currently playing category.

*Scrolls to the position of the specified character*



Scrolls to the selected character.

# Radio Listening

Various control screens appear in the Tuner Source mode.



- Set the remote controller mode switch to "AUD" mode before starting operation, see <Remote Controller mode switch> (page 96).

## Source Control Screen

Switches to the source control screen to use various functions.

### 1 Display the Source Control Screen

See <How to Display the Source Control Screen> (page 18).

### 2 Operation on the Source Control screen



**[FM]** Switches to the FM1/2/3 band.

**[AM]** Switches to the AM band.

**[TI]** Turns the Traffic Information function On or Off.

See <Traffic Information> (page 40).

**[◀◀], [▶▶]** Tunes in a station.

Use the [SEEK] to change the frequency switching.

**[2]** Display the Tuner Preset List Screen.  
See <Preset Select> (page 38).

**[1]** Information display

**[FM]** Selects the Program Service Name, Title & Artist name, Station name, Radio Text plus, or Radio Text.

**"FM"/ "AM"** Band display

**"Preset"** Preset number

**"MHz"/ "kHz"** Frequency display

**[◀◀]** When appears, the text display is scrolled by touching it.

## Multi Function

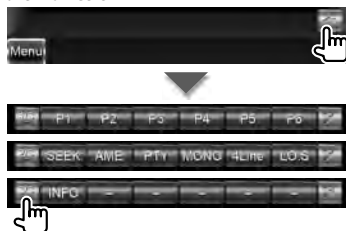

**[1/3]** Switches the multi function display.

Closes the multi function bar.

**[P1] – [P6]** When [P1] to [P6] buttons appear, you can recall the stations on memory.

For memory of broadcasting stations, see <Auto Memory> (page 38) or <Manual Memory> (page 39).

**[SEEK]** Switches the Seek mode.

The mode is switched in the following order each time you touch the button.

Display	Setting
"AUTO1"	Tunes in a station with good reception automatically.
"AUTO2"	Tunes in stations in memory one after another.
"MANU"	Switches to the next frequency manually.

**[AME]** Selects the Auto Memory mode.  
See <Auto Memory> (page 38).

**[PTY]** Searches for stations by program type. See <Search by Program Type> (page 40).

**[MONO]** Select the Monaural reception.

Next page ►

## Radio Listening

**[4Line]/ [2Line]**  **FM** Switches the number of lines displayed in the Information Display.

**[LO.S]**  **FM** Turns the Local Seek function ON or Off.

**[INFO]**  **FM** Displays Radio Text screen. See <Radio Text> (page 39).

### Preset Select

Lists and selects memorized station.

#### 1 Display the Source Control Screen

See <Source Control Screen> (page 37).

#### 2 Display the Tuner Preset List Screen



#### 3 Select a station

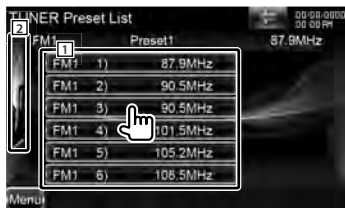

1 Memorized stations are displayed.

Touch to tune in.

2 Returns to the Source Control screen.

### Auto Memory

Stores stations with good reception in memory automatically.

#### 1 Display the Source Control Screen

See <Source Control Screen> (page 37).

#### 2 Select a band you wish to store in memory



#### 3 Select the Auto Memory mode



#### 4 Start Auto Memory



Auto Memory terminates when 6 stations are stored or when all stations are tuned in.



The operation ends automatically if you do not operate within 10 seconds.

## Manual Memory

Stores the current receiving station in memory.

- 1 Display the Source Control Screen**  
See <Source Control Screen> (page 37).
- 2 Select a station you wish to store in memory**



- 3 Store in memory**



Continue to touch until the memory number appears.

## Radio Text

You can display the radio text. (Only when receiving the FM broadcast)

- 1 Select a station**  
See <Source Control Screen> (page 37).
- 2 Display the radio text**

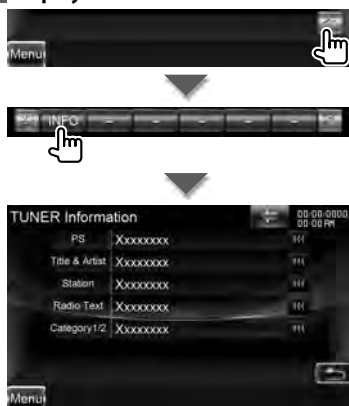

Program Service Name, Title & Artist name, Station Name, Radio Text, or Category name 1/2 display.

[◀▶] When ◀▶ appears, the text display is scrolled by touching it.

## Traffic Information

When a traffic bulletin starts, any source is switched to the traffic information and it is displayed automatically.

### 1 Display the Source Control Screen

See <Source Control Screen> (page 37).

### 2 Set the Traffic information mode



#### When the traffic bulletin starts...

The Traffic Information screen appears automatically.

#### Traffic Information screen



- It is necessary to have Traffic Information function set to On in order to have the Traffic Information screen appear automatically.
- During reception of traffic information the adjusted volume is automatically remembered, and the next time it switches to traffic information it's automatically the remembered volume.

## Search by Program Type

A program is tuned when you set its program type. (Only when receiving the FM broadcast)

### 1 Display the Source Control Screen

See <Source Control Screen> (page 37).

### 2 Enter Program Type Search mode



### 3 Select a Program Type

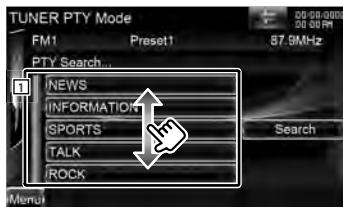

1 Program Type is displayed. Touch to select a Program Type.

**[Search]** Searches for the program type. It is displayed when the Program type is selected.

### 4 Search a station of the selected Program Type





# TV Watching

Various control screens appear in the TV source mode. You can only operate TV with the optional accessory TV Tuner connected.

## Function During TV Screen

Basic functions are available even when the TV screen is displayed.

### 1 Display the TV screen

See <Operation on the Playback Screen of Visual Sources> (page 19).

### 2 Operation on the TV screen



- 1 Switches to TV1 or TV2.
- 1 Displays Menu Control Screen (only with KTC-D500E (optional accessory) connected). See <TV Menu> (page 43).
- 2 Displays Easy Control Screen.
- 3, 4 Selects a channel.

## Easy Control Screen

Displays the basic operation buttons on the screen.

### 1 Display the Easy Control Screen



### 2 Operation on the Easy Control Screen

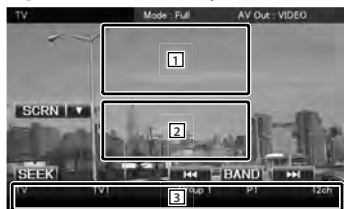

- 1, 2 Switches to the TV screen.
- 3 Displays the Source Control Screen.
- [BAND] Switches to TV1 or TV2.
- [◀◀], [▶▶] Selects a channel.  
Use the [SEEK] to change the channel tuning sequence.
- [SEEK] Switches the Seek mode. (page 42)

## Source Control Screen

Switches to source control screen to use various functions.

### 1 Display the Source Control Screen

See <How to Display the Source Control Screen> (page 18).

### 2 Operation on the Source Control Screen



[BAND] Switches to TV1 or TV2.

[◀◀], [▶▶] Select a channel.

Use the [SEEK] to change the channel tuning sequence.

2 Display the TV Preset List Screen. See <Preset Select> (page 44).

[TV] Switches to the TV screen.

1 Information display

Channel information display

"TV" Band display

"Group" TV Area Group Display. See <TV Setup> (page 95).

"Preset" Memory Number Display

"ch" Channel display

[◀◀] When ◀◀ appears, the text display is scrolled by touching it.

## Multi Function

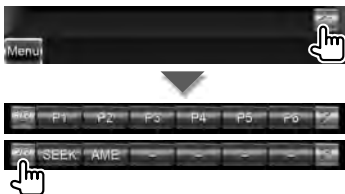

[1/2] Switches the multi function display.

[X] Closes the multi function bar.

[P1] – [P6] When [P1] to [P6] buttons appear, you can recall channels on memory.

For memory of broadcasting stations, see <Auto Memory> (page 43) or <Manual Memory> (page 44).

[SEEK] Switches the Seek mode.

The mode is switched in the following order each time you touch the button.

Display	Setting
"AUTO1"	Tunes in a station with good reception automatically.
"AUTO2"	Tunes in stations in memory one after another.
"MANU"	Switches to the next frequency manually.

[AME] Selects the Auto Memory mode. See <Auto Memory> (page 43).

## TV Menu (only with KTC-D500E (optional accessory) connected)

Menu Control screen appears by touching the area shown below.

### 1 Display the TV screen

See <Operation on the Playback Screen of Visual Sources> (page 19).

### 2 Display the Menu Control screen



### 3 Operation on the Menu Control screen



[Menu] Shows Digital TV Broadcasting menu screen.

[EPG] Shows EPG (Electric Program Guide) screen.

[◀], [▶], [▲], [▼] Moves highlight in Digital TV Broadcasting menu.

[Enter] Executes selected menu item.

[Return] Returns to the previous screen.

[Exit] Returns to Digital TV screen.

## Auto Memory

Stores stations with good reception in memory automatically.

### 1 Display the Source Control Screen

See <Source Control Screen> (page 42).

### 2 Select a band you wish to store in memory



### 3 Select the Auto Memory mode



### 4 Start Auto Memory



Auto Memory terminates when 6 stations are stored or when all stations are tuned in.



- The operation ends automatically if you do not operate within 10 seconds.

## Manual Memory

Stores the current receiving channel in memory.

### 1 Display the Source Control Screen

See <Source Control Screen> (page 42).

### 2 Select a station you wish to store in memory



### 3 Store in memory

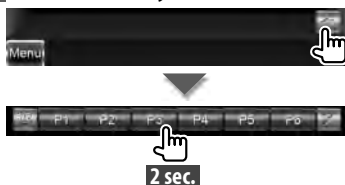

Continue to touch until the memory number appears.

## Preset Select

Lists and selects memorized station.

### 1 Display the Source Control Screen

See <Source Control Screen> (page 42).

### 2 Start Preset Select



### 3 Select a station



1 Memorized stations are displayed.

Touch to tune in.

2 Returns to the Source Control screen.

3 Switches to the TV screen.

# Bluetooth Audio Control

You can listen to audio files stored in a Bluetooth audio player or cell-phone.

## Before Use

- For details on the Bluetooth Audio player which can be connected, see <About the Bluetooth Audio player> (page 8).
- You need to register your audio player and cell-phone before using it with this unit. For more details, see <Registering Bluetooth Unit> (page 79).
- If you have registered two or more audio players or cell-phones, you need to select one of them. For more details, see <Bluetooth Unit Connection> (page 81).
- Sound output speaker can be set. See <Bluetooth Hands-Free/Audio Output Setup> (page 82).

## Source Control Screen

Switches to control screen to use various functions.

### 1 Display the Source Control Screen

See <How to Display the Source Control Screen> (page 18).

### 2 Operation on the Source Control screen



[▶]\*<sup>1</sup> Plays.

[■]\*<sup>1</sup> Stops playing.

[||]\*<sup>1</sup> Pauses.

[◀▶]\*<sup>1</sup> Selects a file.

[i] Information display

Selects Device, Title\*<sup>2</sup>, Artist Name\*<sup>2</sup>, Album Name\*<sup>2</sup>, Genre\*<sup>2</sup>, Composer\*<sup>2</sup>, or Track Number\*<sup>2</sup>.



- \*<sup>1</sup> If the Bluetooth Audio player does not support AVRCP profile, buttons are not displayed. Operate from the Audio player.
- \*<sup>2</sup> If the Bluetooth Audio player supports AVRCP1.3 profile, these items can be displayed.

## Voice Control (DNX9260BT only)

The unit is equipped with Advanced Speech Recognition function which allows you to operate it with your voice. The supported languages are US English, UK English, French, German, Dutch, Italian, and Spanish. For information on the voice commands, refer to <Voice command table> (separate volume).



- ASR on the Language Setting screen should be set to "Enabled". See <Language Setting> (page 70).

### Voice Control

#### 1 Enter into the Voice control mode

Press the TALK switch.

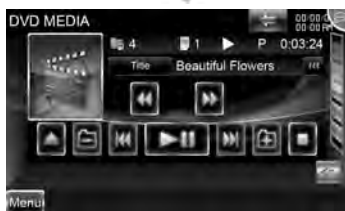

The buttons enclosed in a green square support the voice control.

#### 2 Speak the command

Speak the command. (Ex: Speak "Top Menu".)

You will hear a beep.



The screen has changed to the Top Menu screen.

You will hear a beep again.

#### 3 Speak the command

Speak the command. (Ex: Speak "TUNER".)  
You will hear a beep.



The screen has changed to the Tuner Control screen.

You will hear a beep again.

#### 4 Control the source with voice control

Repeat the same procedure as step 2 or 3.

For information on the voice commands, refer to <Voice command table> (separate volume).

#### 5 End the voice control mode

Press the TALK switch.



- The voice control is disabled when  is displayed on the upper-right corner of the screen.
- The voice control is canceled when the screen is touched or any of the buttons, except the [VOLUME] button, on the front panel or the remote control unit is pressed.
- The voice control is disabled while talking on the phone with hands-free.

- 
- The voice control is canceled if no operation is continued for a certain period of time.

## Other Functions

### External Device Power Supply Control

Controlling the external device power supply.

#### 1 Display the Source Select Screen

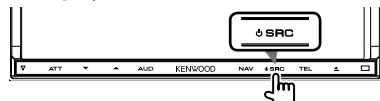

#### 2 Display the EXT SW Control screen



#### 3 Control the external device power supply

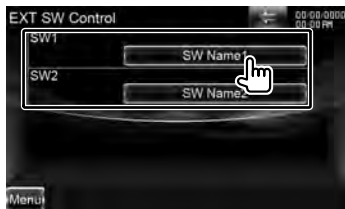

You can turn on or off the external device power supply.



- You must connect a commercially available relay unit in order to use this function. Connect the external device to be controlled to that relay unit.
- Refer to <EXT SW Setup> (page 74) for information on setting the power on or off specification.

### Muting Audio Volume upon Reception of Phone Call

#### When a telephone call is made or received...

The Phone Call ("Call Interrupt") screen appears, and system is paused.

#### Phone Call ("Call Interrupt") screen



#### When the call ends...

##### Hang up the phone.

The system resumes playing automatically.



- To use the TEL Mute feature, you need to hook up the MUTE wire to your telephone using a commercial telephone accessory. Refer to <INSTALLATION MANUAL>.



# Screen Control

Setting the monitor screen.

## Screen Control

### 1 Display the Easy Control Screen

See <Operation on the Playback Screen of Visual Sources> (page 19).

### 2 Display the Screen Control screen



When the navigation screen is displayed, press the [TEL] button for 1 second or more.

### 3 Adjust the picture quality



**[Bright]** Brightness Control

**[Tint]** Tint Control

Displayed for an NTSC system image on Video, iPod, TV or Camera View.

**[Color]** Color Control

Displayed on Video, iPod, TV or Camera View screen only.

**[Contrast]** Contrast Control

**[Black]** Black Level Adjustment

**[Sharpness]** Sharpness control

Displayed on Video, iPod, USB, TV or Camera View screen only.

**[Dimmer]** Dimmer Mode Setup

"ON": The display dims.

"OFF": The display doesn't dim.

"SYNC": Turning the Dimmer function

On or Off when the vehicle light control switch is turned On or Off.

"NAV-SYNC": Turning the Dimmer function On or Off according to the Navigation Day/Night display setting. (DNX series and DDX series with navigation unit only)

**[Dyn.Brightness]** (Dynamic Brightness)

The function compensates for Over Exposure and Under Exposure creating a clearer picture. (☑ "OFF")

"OFF"/ "1"/ "2"

**[Mode]** Selects a screen mode.

You can select any of the following screen mode.

"Full": Full picture mode

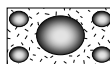

"Just": Justify picture mode

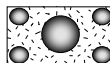

"Zoom": Zoom picture mode

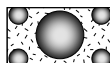

"Normal": Normal picture mode

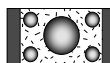

- The Screen Control screen is displayed only when you have applied the parking brake.
- The picture quality can be set for each source.
- You can set image quality of screens such as menu from <Screen Control> (page 78).

# Hands Free Unit Control

Various functions can be used in the Hands Free control mode.

## Before Use

- For details on the Bluetooth cell-phone with the hands-free function, see <About the Cell-Phone> (page 8).
- You need to register your cell-phone before using it with this unit. For more details, see <Registering Bluetooth Unit> (page 79).
- If you have registered two or more cell-phones, you need to select one of them. For more details, see <Bluetooth Unit Connection> (page 81).
- To use the Phone Book, it must be downloaded to this unit in advance. For details, see <Downloading the Phonebook> (page 50).
- Sound output speaker can be set. See <Bluetooth Hands-Free/Audio Output Setup> (page 82).

## Downloading the Phonebook

Downloads the phonebook data from the cell-phone to this unit so that you can use the Phonebook of this unit.

- 1 By operating the cell-phone, send the phonebook data to this unit**
- 2 By operating the cell-phone, start the hands-free connection**





- For the cell-phones which support auto-download of phonebook:  
If the phonebook is not downloaded automatically for some reasons, follow the procedure above to download manually.
- For how to operate the cell-phone, refer to the Instruction Manual that comes with your cell-phone.
- Up to 1000 phone numbers can be registered for each registered cell-phone.
- Up to 32 digits can be registered for each phone number along with up to 50\* characters representing a name.  
(\* 50: Number of alphabetical characters. Fewer characters can be input depending on the type

of characters.)

- Depending on the type of your cell-phone, the following restrictions are placed:
  - The phonebook data cannot be downloaded normally.
  - Characters in the Phonebook are garbled.
- To cancel downloading of the phonebook data, operate the cell-phone.

## Receiving a Call



- [  ] Answering a Phone Call
- [  ] Rejecting an Incoming Call



- While monitoring the camera view, this screen is not displayed even if a call comes in. To display this screen, press the [TEL] button or return the shift knob of car to the drive position.

## During a Call



[] Switches the voice output between phone and speaker.

[DTMF] Outputs dial tone. See <Controlling Tone-based Services> (page 56).

[] Disconnecting a call

### Adjusting the Voice Volume during a Call

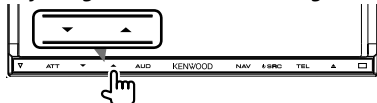

## Call Waiting



- [] • Answers another incoming call with the current call suspended.
- Switching between the current call and waiting call  
Each touch of this button switches the calling party.
- [] Terminates the current call.

## Making a Call

Displaying the control screen and using various functions.

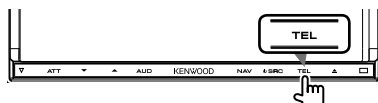

### 1 Display the Hands-Free Control screen





### 2 Select a dialing method



- 1 Calls the displayed phone number.  
If you have registered a phone number in the Phonebook, the person's name is displayed.
- [] Calls the displayed phone number.
  - [] Displays the SMS Select screen. See <SMS (Short Message Service)> (page 60).
  - [Redial] Displays the previously called phone number.
  - [Preset1], [Preset2], [Home] (DNX9 series)  
Calls the preset phone number.
  - [Preset1-3] (DNX7/ DDX8 series)  
Calls the preset phone number.  
For information on how to preset a phone number, see <Phone Number Preset> (page 59).
  - [] Phonebook Displays the Phonebook Search. See <Calling by Phonebook> (page 52).

- [ Outgoing Calls]** Displays the Outgoing Calls screen. See <Making a Call Using Call Records> (page 54).
- [ Incoming Calls]** Displays the Incoming Calls screen. See <Making a Call Using Call Records> (page 54).
- [ Missed Calls]** Displays the Missed Calls screen. See <Making a Call Using Call Records> (page 54).
- [Direct Number]** Displays the Dialing Display screen. See <Calling by Entering a Phone Number> (page 53).
- [Voice]** Starts voice recognition. See <Calling by Voice Recognition> (page 54). (DNX7/ DDX8 series only)
- [BT SETUP]** Displays the Bluetooth SETUP screen. See <Registering Bluetooth Unit> (page 79).
- [TEL SETUP]** Displays the Hands Free Setup screen. See <Setting Up the Hands-Free Phone> (page 56).



- While your car is moving, some functions are disabled for safety reasons. The buttons associated with the disabled functions become ineffective if pressed.
- When the Hands-Free Control screen appears, the name of the connected cell-phone is displayed for 5 seconds.
- The status icons such as  and  displayed on the control unit may discord from those displayed on the cell-phone.
- Setting the cell-phone in the private mode can disable the hands-free function.

## Calling by Phonebook

You can call a person using his/her phone number that you have registered in the Phonebook.

### 1 Display the Hands-Free Control screen



See <Making a Call> (page 51).

### 2 Display the Phonebook screen

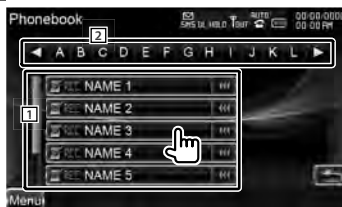

### 3 Select the name to call



- 1 Phonebook data list.
  - 2 Displays the Phonebook name beginning with the character you have touched.
- [] When  appears, the text display is scrolled by touching it.

#### 4 Select the phone number to call

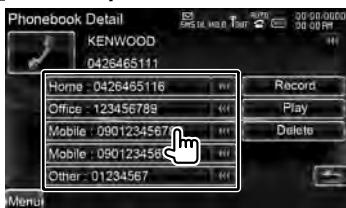

#### 5 Make a call



- To use the Phonebook, it must have been downloaded from the cell-phone. For more details, see the instruction manual of your cell-phone.
- Characters with no corresponding name will not be displayed.
- During search, a non-accent character such as "u" is searched for instead of an accent character such as "ü".

### Calling by Entering a Phone Number

Makes a call by entering a phone number.

#### 1 Display the Hands-Free Control screen

See <Making a Call> (page 51).

#### 2 Display the number input screen

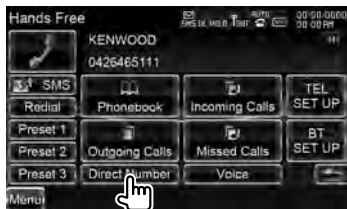

#### 3 Enter a phone number



1 Calls the entered phone number.

[Clear] Clears the number.

#### 4 Make a call

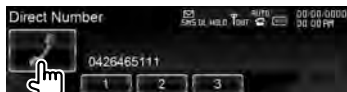

You can start talking when the recipient responds.



- You can input up to 32 digits.
- This function is unavailable while driving.

### Making a Call Using Call Records

Calls by selecting a phone number from the outgoing, incoming, or missed calls list.

#### 1 Display the Hands-Free Control screen

See <Making a Call> (page 51).

#### 2 Display the Outgoing Calls, Incoming Calls, or Missed Calls screen

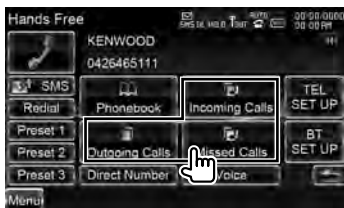

#### 3 Select from calls list

Example : Outgoing Calls screen

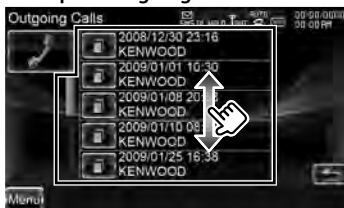

Calls the selected phone number.

#### 4 Make a call

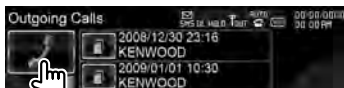

- The Outgoing Calls list screen, Incoming Calls list, or Missed Calls list screen shows the list of the calls originated from or received at this unit. They are not the ones stored in the cell-phone memory.

### Calling by Voice Recognition (DNX7/ DDX8 series)

Calls by recognizing the registered voice.



- In order to perform voice recognition, voice must be registered in the Phonebook data. See <Voice Registration> (page 57). Or, to perform voice recognition by Phone number category (Home, Office, Mobile etc.) of Phonebook data, a key word voice must be registered. See <Key Word Voice Registration> (page 58).

#### 1 Display the Hands-Free Control screen

See <Making a Call> (page 51).

#### 2 Display the Voice Recognition screen



- If there is only one phone number assigned under the registered name

#### 3 Say the name registered in the Phonebook



When a beep is heard, say the name within 2 seconds.

#### 4 Make a call



■ **If there is more than one phone number assigned under the registered name**

#### 5 Say the key word registered for the category



When a beep is heard, say the category within 2 seconds.

#### 6 Make a call



■ **If there are more than one phone numbers registered under the same name, go to step 7.**

#### 7 Select a Phone number category

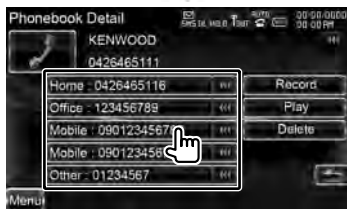
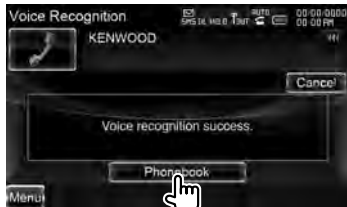

Selects the Phone number category.

#### 8 Make a call



• A message is displayed if the voice is not recognized. Read the message for the further operation.

## Controlling Tone-based Services

Uses tone base service using DTMF (Dual Tone Multi Frequency).

### 1 Display the Talking screen

See <Calling by Entering a Phone Number> (page 53).

### 2 Display the DTMF input screen



### 3 You can send tones during a call



## Setting Up the Hands-Free Phone

The Hands-Free system can be set as follows.

### 1 Display the Hands-Free Control screen

See <Making a Call> (page 51).

### 2 Display the Hands Free Setup screen



### 3 Set each item

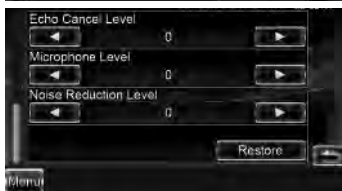
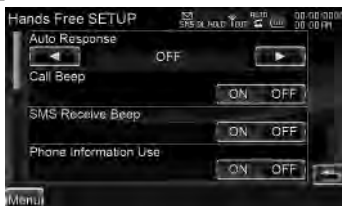

**[Auto Response]** Sets an automatic response time after call termination.  
 (OFF) "OFF"  
 "OFF": This function can not use.  
 "0-99": Sets to calling ring time (second).



**[Call Beep]** Sets the beep of the incoming call. (📌 "ON")

"ON": Beep is heard.

"OFF": Beep is canceled.

**[SMS Receive Beep]** Sets the beep of the incoming SMS. (📌 "ON")

"ON": Beep is heard.

"OFF": Beep is canceled.

**[Phone Information Use]** Sets whether to use cell-phone phonebook, outgoing calls list, incoming calls list and missed calls list. (📌 "ON")

"ON": Yes.

"OFF": No.

**[SMS Use]** Sets the SMS function.

(📌 "ON")

"ON": Use SMS function.

"OFF": SMS not available.

**[Key Word]** Registers the voice to select phone number category with voice recognition. See <Key Word Voice Registration> (page 58). (DNX7/ DDX8 series only)

**[Echo Cancel Level]** Adjust the level of echo cancellation. (📌 "15")

**[Microphone Level]** Adjusts the sensitivity of the microphone for a telephone call. (📌 "2")

**[Noise Reduction Level]** Reduce the noises generated by surrounding environment without changing the microphone volume. Adjust the voice of caller when it is not clear. (📌 "15")

**[Restore]** Restores the Hands Free SETUP value to the initial value.



- Either the time interval for automatic answer set on this unit or the time interval set on the cell-phone, whichever is shorter, takes effect.

## Voice Registration (DNX7/ DDX8 series)

Registers voice for voice recognition in Phonebook. Up to 35 voices can be recorded in one cell-phone.

### 1 Display the Phonebook Detail screen

Go through the procedure of <Calling by Phonebook> (page 52).

### 2 Display the voice registration screen



**[Record]** Registers the voice for voice recognition to the selected Phonebook. If there are already 35 voice tag registered in the same cell-phone, [Record] button is deactivated.

**[Play]** Plays the voice registered in the selected Phonebook data.

**[Delete]** Deletes the voice registered in the selected Phonebook data. Touch to display the confirmation screen. Touch [Yes] to delete or [No] to cancel.

### 3 Say the name to register (1st try)



Say within 2 seconds after the Beep.

### 4 Say the name to register (2nd try)

Say within 2 seconds after the Beep.

### 5 End voice registration

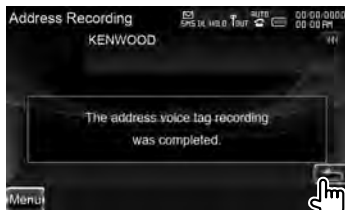

- A message is displayed if the voice is not recognized. Read the message for the further operation.
- Repeat from 1st try if the voice is different from the 1st try.

## Key Word Voice Registration (DNX7/ DDX8 series)

Registers the voice to select the Phone number category by Voice Recognition.

### 1 Display the Hands Free Setup screen

See <Setting Up the Hands-Free Phone> (page 56).

### 2 Display the Key Word List screen

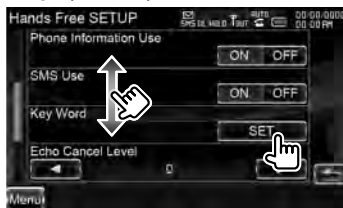

### 3 Select the Phone number category to register



- 1 Selects the Phone number category. "REC" turns on for data with voice for voice recognition already registered.

**[Record]** Registers voice for the selected Phone number category.

**[Play]** Plays voice registered for the selected Phone number category.

**[Delete]** Deletes voice registered for the selected Phone number category. Touch to display the confirmation screen. Touch [Yes] to delete or [No] to cancel.

#### 4 Display voice registration screen



#### 5 Say the phone category to register (1st try)



Say within 2 seconds after the Beep.

#### 6 Say the phone category to register (2nd try)

Say within 2 seconds after the Beep.

#### 7 End voice registration

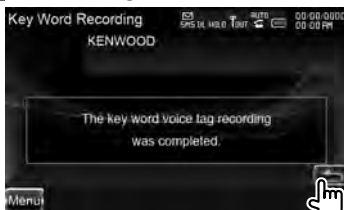

- A message is displayed if the voice is not recognized. Read the message for the further operation.
- Repeat from 1st try if the voice is different from the 1st try.

## Phone Number Preset

Registers frequently used phone number to Hands Free control screen preset button.

#### 1 Display the Hands-Free Control screen

See <Making a Call> (page 51).

#### 2 Select the Preset number to register



- If no Preset number is registered, pressing this button momentarily moves to the step 3.

#### 3 Select the search destination of the number to register



- [📧] Registers from SMS received message list.
- [📧] Registers from SMS sent message list.
- [📖] Registers from Phonebook.
- [📞] Registers from outgoing calls list.
- [📞] Registers from incoming calls list.
- [📞] Registers from missed calls list.

## Hands Free Unit Control

**[Direct Number]** Registers by entering phone numbers.

**[Voice]** Registers voice for voice recognition to preset number. (DNX7/DDX8 series only)

**[Memory]** Registers the currently displayed phone number.

**[Delete]** Deletes the currently displayed phone number. Touch to display the confirmation screen. Touch [Yes] to delete or [No] to cancel.

### 4 Search phone number to register with each function

#### 5 Register phone number



## SMS (Short Message Service)

Uses SMS function.

### 1 Display the Hands-Free Control screen

See <Making a Call> (page 51).

### 2 Display the SMS Select screen



### 3 Select a function



[] Displays the SMS Create Menu screen. See <Create a message>.

[] Displays received message list.

[] Displays sent message list.

[] Displays the SMS Create Menu screen. See <Create a message>.

The button will be active when any message has been created after power-on.

**[Download]** Retrieves SMS messages from the cell-phone.

### 4 Select a message to display



[1] Calls the number in the selected message.

**[DISP]** Displays the selected message.

**[Read]** Reads out the selected message. (DNX9260BT only)

## 5 SMS Message screen

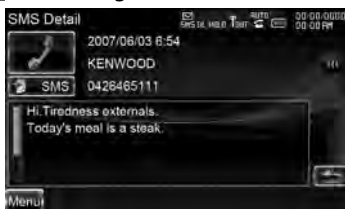

[SMS] Creates a new message for the selected message.

### Create a message

#### 1 Input the destination



[📖] Select a destination from the phonebook.

[Direct Number] Enter the phone number.

[SET] Display the Create SMS Message screen.

[Send] Sends the message.

[Delete] Deletes the Draft message. Touching the screen displays a confirmation message. Touch [Yes]. To cancel clearing, touch [No].



• This is displayed only when the Draft message is being edited.

#### 2 Display the Create SMS Message screen



#### 3 Create a message



[1] Enters characters.

[◀], [▶] Moves the cursor.

[▲], [▼] Scrolls up or down the character button display.

[Shift] Toggles between uppercase and lowercase.

[qwe]/ [abc]/ [ALT] Sets the key layout of the character buttons.

abc : Alphabetical key layout.

qwe : Qwerty key layout.

ALT : Alternate key

[Clear] Erases the entered character. If touched more than 2 seconds, all the input characters are erased.

[Space] Enters a space.

[SET] Determines the message and returns to the SMS Create Menu screen.

#### 4 Send the message



# Audio Control

## Audio Control Menu

Displays the Audio Control menu to set the sound effect function of this unit.

### 1 Display the Source Control Screen

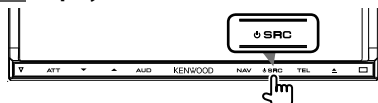

When a video screen is displayed, press the [SRC] button.

### 2 Display the Audio Control menu



In this manual, the above selection is indicated as:

Touch   .

### 3 Select the Audio Control item



Item	Page
[Audio Control]	62
[Equalizer]	63
└ [EQ]	63
[Zone Control]	64
[SRS WOW]	66
[Space Enhancer]	65

Item	Page
[Position]	65
[Surround Control]	67

## Audio Control

You can adjust the front/rear and right/left audio balance.

### 1 Display the Audio Control screen

Touch    [Audio Control]. (page 62)

### 2 Set each item

#### DNX9/ DDX8 series



#### DNX7 series



1 Adjusts the front/back and left/right volume around the touched area.

[◀], [▶] Adjusts the right and left volume balance.

[▲], [▼] Adjusts the front and rear volume balance.

[Volume Offset] Finely adjust the volume of the current source to minimize the difference in volume between different sources.



• If you have increased the volume first, then

reduced the volume using the "Volume Offset", the sound generated if you suddenly switch to another source may be extremely loud.

**[Subwoofer Level]** Adjusts the subwoofer volume.

The setting is available when subwoofer is set to any item other than "None". See <Speaker Setup> (page 86).

**[Bass Boost]** Sets the amount of bass boost. (DNX7 series only)  
"OFF"/ "Step1"/ "Step2"

**[Supreme]** Turns ON/OFF the Supreme function. (DNX9/ DDX8 series only)  
Technology to extrapolate and supplement with proprietary algorithm, the high-frequency range that is cut off when encoding.  
This function works on DVD, USB, SD and iPod sources.

## Equalizer Control

You can set up the equalizer.

### 1 Display the Equalizer screen

Touch  >  > [Equalizer].  
(page 62)

### 2 Select EQ curves



**[Natural]**, **[Rock]**, **[Pops]**, **[Easy]**,  
**[Top40]**, **[Jazz]**, **[Game]**, **[iPod]**, **[User]**

Selects an equalizer curve type.

You can select any of the following equalizer curves.



- [iPod]  
During iPod source only.

**[EQ]** Displays the Graphic Equalizer setup screen. (page 63)

## Graphic Equalizer Setup

You can Manually set the equalizer curve.

### 1 Display the Equalizer screen

Touch  >  > [Equalizer].  
(page 62)

### 2 Display the Graphic Equalizer screen



- When "iPod" is selected in <Equalizer Control>, the [EQ] button is deactivated.  
"iPod" uses its equalizer function.

### 3 Select the channel to be adjusted (DNX9/ DDX8 series only)

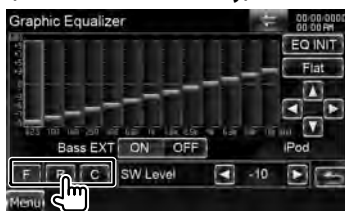

**[F]** Front speaker  
**[R]** Rear speaker  
**[C]** Center speaker

#### 4 Set the Graphic Equalizer

##### DNX9/ DDX8 series



##### DNX7 series



- Gain level can be adjusted by touching the each frequency bar.  
 [◀], [▶] Sets a frequency.  
 [▲], [▼] Sets a gain level.

**[EQ Init]** Returns to the previous level which the gain level is adjusted.

**[Flat]** Tone curve becomes flat.

**[Bass EXT]** Bass Extend settings.  
 When turned on, the frequency lower than 62.5 Hz is set to the same gain level as 62.5Hz.

**[SW Level]** Adjusts the subwoofer volume.  
 The setting is available when subwoofer is set to any item other than "None". See <Speaker Setup> (page 86).

#### Zone Control

You can set the front and rear audio source.

##### 1 Display the Zone Control screen

Touch [◀] [▶] [Zone Control] [Zone Control]. (page 62)

##### 2 Set the Zone Control



**[Single Zone]** Sets the unit to single zone.

**[Dual Zone]** Sets the unit to dual zone.

**[Front Source]** Sets the front audio source.

**[Rear Source]** Sets the rear audio source.



- When the rear speaker sound is switched, the audio source that is output at the AV OUTPUT terminal is also switched to the same source.

**[Rear VOL.]** Adjusts the volume of the rear channel.



- There are following limitations when zone function is set to "ON".



- There is no output from the subwoofer or center speaker.
- "Subwoofer Level", "Bass Boost", and "Supreme" of <Audio Control> (page 62) is not available.
- <Equalizer Control> (page 63), <Space Enhancer> (page 65), <Listening Position> (page 65), <SRS WOW Control> (page 66), and <Surround Control> (page 67) are not available.
- <DSP Bypass Control> (page 85), <Speaker Setup> (page 86), <Car Type (DTA) Setup> (page 87), and <Channel Level> (page 89) are not available.

## Space Enhancer (DNX7 series)

You can enhance the soundscape.

### 1 Display the Space Enhancer screen

Touch [Left Arrow] > [Right Arrow] > [Space Enhancer]. (page 62)

### 2 Set the Space Enhancer



1 Sets the soundscape level.



- You cannot set Space Enhancer in tuner source.

## Listening Position

You can adjust the sound effects according to your listening position.

### 1 Display the Position screen

Touch [Left Arrow] > [Right Arrow] > [Position]. (page 62)

### 2 Set the Position Control



[P1] - [P3] Stores the present adjustment setup in memory, or recalls it from memory.

**To store your adjustment in memory:**  
Continue to touch [P1] to [P3] more than 2 seconds.

**To call your adjustment from memory:**  
Touch [P1] to [P3] of your adjustment you wish to recall from memory.

[Left Arrow], [Right Arrow] Sets a listening position.

You can select any of "Front R" (Right front), "Front L" (Left front), "Front All" (All front), "All" (All), and "User" (User) positions.

[DTA] Displays the Position DTA (Digital Time Alignment) screen.

### 3 Exit Position Control



- The final distance is adjusted to the total of Car Type Set Up value (page 87) and Position Setup (both Position and Position DTA) value.
- If you change the Car Type Set Up value (page 87), the position is set to "All".

**Next page ►**

## Audio Control

- Only the adjusted distance of position setup (Position and Position DTA values) is stored in memory. Therefore, the final adjustment distance changes if you change the Car Type Set Up value (page 87).

### Position DTA Control

You can fine-adjust your listening position.

#### 1 Display the Position DTA screen



#### 2 Select a speaker you wish to adjust

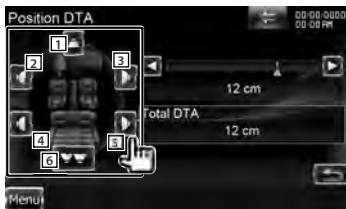

- 1 Center speaker (DNX9/ DDX8 series)
- 2 Left front speaker
- 3 Right front speaker
- 4 Left rear speaker
- 5 Right rear speaker
- 6 Subwoofer

[◀], [▶] Finely adjusts the value set with the Position function.

**[Total DTA]** Indicates setup distance.

The adjusted distance (Position and Position DTA values), and the total of the distance adjusted by Car Type Set Up (page 87) and the adjustment distance for position setup are indicated.

#### 3 Finely adjust the distance



Finely adjust the value set with the Position function.

## SRS WOW Control (DNX9/ DDX8 series)

You can set up the SRS WOW effect.

#### 1 Display the SRS WOW Control screen

Touch [◀] [▶] [SRS WOW]. (page 62)

#### 2 Set the SRS WOW Control



- 1 Selects SRS WOW setting.

### SRS WOW User Setup

#### 1 Display the SRS WOW Adjust screen



#### 2 Adjust the SRS settings



- 1 Selects a speaker to be set (Front, Rear or Center speaker).

**[TruBass]** Sets the TruBass effect level.

**[FOCUS]** Sets the FOCUS effect level.

**[SRS 3D]** Sets the SRS 3D effect level.



- **FOCUS:** Adjusts the vertical position of the speaker and sound image by virtual adjustment.
- **TruBass:** Assists the playback for the super bass sound.
- **SRS 3D:** Makes a natural 3D sound field.
- Some items cannot be adjusted depending on the selected speaker.
- **SRS WOW control** is not available in tuner source and TV source.
- When Surround Control is Dolby Pro Logic II, SRS WOW control is not available.

## Surround Control (Dolby Digital / DTS series)

You can set up the sound field.

### 1 Display the Surround Control screen

Touch [Surround Control]. (page 62)

### 2 Set the Surround Control



#### 1 Sets a sound field.

You can select any of the following sound fields.

"Bypass"/ "Bypass+Center"/ "Dolby Pro Logic II Movie"/ "Dolby Pro Logic II Music"/ "Dolby Pro Logic II Matrix"

**[Stream Information]** Displays the present source information.

The stream (Dolby Digital, dts, Linear PCM, MPEG, SDDS, AAC or MP3/WMA), input channels (front or rear channels), and sampling frequency are displayed.



- When you have selected the TV or TUNER source and when you set the Dolby PL, we recommend you to select the "Dolby PLII Matrix" mode. If you select another Dolby PLII mode, the sound is NOT output from rear speakers when you receive monaural broadcasting sounds.
- Surround control can be set for each source.

## Dolby Pro Logic II Music Adjustment

### 1 Display the Dolby Pro Logic II Music Adjust screen



### 2 Adjust the sound field

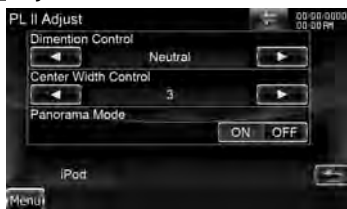

**[Dimension Control]** Sets the surround position by adjusting the front and rear volume balance.

**[Center Width Control]** Sets the vocal image position by adjusting the right and left vocal volume level.

**[Panorama Mode]** Turns the Panorama mode On or Off.



- You cannot use the <Surround Control Adjustment> during playback of a Multi-channel source.

# Setup Menu

You can set up various receiver parameters.

## How to Display SETUP Menu Screen

Displays the Setup menu to set various functions.

### 1 Display the Source Control Screen

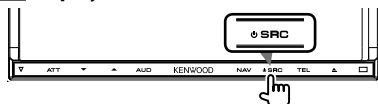

When a video screen is displayed, press the [SRC] button.

### 2 Display the Setup Menu Screen



In this manual, the above selection is indicated as:

Touch  > .

### 3 Select the setup item

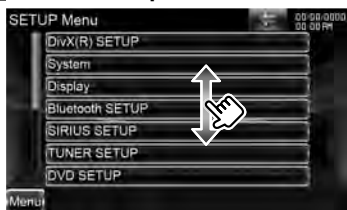

- [AV-IN SETUP], [Navigation] and [Audio SETUP] options can be locked. The key mark (🔒) is displayed in reverse video for the locked option. See <Setup Memory> (page 75).

Item	Page
[DivX(R) SETUP]	69
[System]	
[User Interface]	70
[Touch]	71
[Clock]	72
[Security]	72
[Angle]	73
[EXT SW]	74
[SETUP Memory]	75
[Display]	
[Screen Control]	78
[Color]	77
[Background]	76
[Bluetooth SETUP]	79
[TUNER SETUP]	94
[DVD SETUP]	90
[iPod SETUP]	94
[USB SETUP]	93
[SD SETUP]	93
[TV SETUP]	101
[AV-IN SETUP]	82
[Navigation]	84
[Software]	69
[Audio SETUP]	85
[Speaker Select]	86
[Car Type]	87
[Channel Level]	89
[AV-OUT Interface]	83
[Camera SETUP]	83

## DivX Setup

Checks the registration code. This code is needed when making a disc which has DRM (Digital Rights Management).

### 1 Display the DivX Setup screen

Touch [Left Arrow] > [Right Arrow] > [DivX(R) SETUP]. (page 68)



Displays the registration code.



- Disabled when a DVD is being played.
- When downloading a DivX VOD file controlled by DRM, register the code appeared on the screen such as the one above. Otherwise the file may not be able to play with this unit. Remaining number of viewing is displayed when playing a DivX VOD file with the viewing restriction. When the remaining number of viewing reached 0, a warning message appears and the file cannot be played.

## Deactivating DivX Code

### 1 Display the DivX Deactivation Confirm screen



### 2 Cancel the registration



Touching the screen displays a confirmation message. Touch [OK]. To cancel clearing, touch [Cancel].

## Software Information

Checks the software version of this unit.

### 1 Display the Software Information screen

Touch [Left Arrow] > [Right Arrow] > [Software]. (page 68)



Displays the software version.



- For how to update the software, refer to the relevant update procedure manual which comes with the software.

### User Interface

You can setup user interface parameters.

#### 1 Display the User Interface screen

Touch  >  > [System] > [User Interface]. (page 68)

#### 2 Set each item



**[Beep]** Turns the key touch tone On or Off. (☑ "ON")

**[Remote Sensor]** Selects a remote control signal. (☑ "ON")  
When turned "OFF", the remote control of TV reception is rejected.

**[Language]** Select the language used for the control screen and setting items.  
See <Language Setting> (page 70).

**[Scroll]** Allows scrolling of text display on the Source Control screen.  
(☑ "Manual")  
"Auto": Scrolls the screen automatically.  
"Manual": Allows you to scroll the screen manually.

**[Drawer Close]** Sets whether to close the function bar automatically.  
(☑ "Auto")

**[AUD Key Longer than 1 Second]** Sets the function of the [AUD] button. (page 12)

"V.OFF": Press the [AUD] button for longer than 1 second to turn the display off.

"CAM": Press the [AUD] button for longer than 1 second to switch to camera view.

**[Animation]** Sets whether to display animation. (☑ "ON")

### Language Setting

You can select the display language for the control screen and audio file tags.

#### 1 Display the User Interface screen

Touch  >  > [System] > [User Interface]. (page 68)

#### 2 Display the Language Setting screen

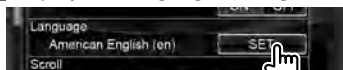

#### 3 Select a language



**[ASR]** Selects whether to use the voice control function. (page 46) (☑ "Enabled") (DNX9260BT only)

Touching [Disabled] allows you to select languages for respective items.

"Enabled": Voice control is activated.

"Disabled": Voice control is deactivated.

**[Select Mode]** Selects the mode to select a language. (☑ "Easy")  
Touching [Advanced] allows you to select languages for respective items.

**[Language Select]** Selects a language. (☑ "British English (en)")

- [Enter]** Determines the selected language.
- [Cancel]** Cancels the selected language.

**When [ASR] is set to "Disabled" (DNX9 only)**

**When [Select Mode] is set to "Advanced"**



**[GUI Language Select]** Selects the display language used for the control screen and so forth.  
(🇬🇧 "British English (en)")

**[Navigation Language Select]** Selects the language used for navigation.  
(🇬🇧 "British English (en)") (DNX7 series only)

**[User Text Language Select]** Selects the language used for tag text (song information).  
(🇬🇧 "British English (en)")

## Touch Panel Adjustment

You can adjust the touch panel operations.

### 1 Display the Touch panel Adjustment screen

Touch [←] > [🔧] > [System] > [Touch]. (page 68)

### 2 Adjust the Touch panel



Follow the instruction on the screen and touch the center of ⊕.

**[Cancel]** Cancels the Touch Panel Adjust.

**[Reset]** Resets to the initial status.

## Clock and Date Setup

You can adjust the clock time.

### 1 Display the Clock Setup screen

Touch   [System] > [Clock]. (page 68)

### 2 Setup the Clock



**1** Adjusts day, month, year, hours, and minute.

**[Reset]** Sets "00" minute.

Setup examples: 3:00 – 3:29 → 3:00  
3:30 – 3:59 → 4:00

**[Synchronize]** Sets the clock time in synchronization with the time data sent from the navigation system or the RDS station. (D/NX series: "Navigation", DDX series: "RDS")  
"OFF"/ "RDS"/ "Navigation"  
When the synchronized mode is set, the clock cannot be adjusted manually.

### 3 Adjust the date or clock time



## Security Setup

You can set a security code to protect your receiver system against theft.



- When the Security Code function is activated, the code cannot be changed and the function cannot be released. Note the Security Code can be set as the 4 digit number of your choice.

### 1 Display the Security screen

Touch   [System] > [Security]. (page 68)

### 2 Setup the SI (Security Indicator)



**[Security Code Set]** Displays the Security code input screen.

**[SI]** Turns the SI function on or off. If turned "ON", the security indicator on the front panel flashes when the vehicle ignition is off. (D/NX series: "ON")

### 3 Start Security Code setup



- If you have already completed the code registration, [Clear] is displayed.



#### 4 Enter a security Code



Input four-digit number.

#### 5 Register your security code



#### 6 Reenter the security code

Reenter the same security code as that you have entered in Step 4 for confirmation.



- If you enter a different security code, the screen returns to Step 4 (for the first code entry).

#### 7 Register the security code again



Now, your security code is registered.

***If you have pressed the Reset button or if you have disconnected the Receiver from battery...***

#### 1 Enter the correct security code



You must enter the same security code as that you have entered in Step 4.

#### 2 Register your security code



Now, you can use your Receiver.

### Monitor Angle Control

You can adjust the position of the monitor.

#### 1 Display the Angle Setup screen

Touch > > [System] > [Angle]. (page 68)

#### 2 Set the Monitor Angle



- 1 Sets the Monitor angle.

**[Off Position]** Stores the current monitor angle as the angle during power off.

**[Auto Open]** When turned on, the front panel is set to open automatically when the ignition is turned off, so that it can be detached for antitheft purpose.

( "OFF")

## EXT SW Setup

Sets up the external switch power mode.

### 1 Display the EXT SW screen

Touch   > [System] > [EXT SW]. (page 68)

### 2 Perform EXT SW Setup



**[SW1 Name]/ [SW2 Name]** Sets the name of the external device. See <How To Use the Character Entry Screen> (page 74) for information on how to enter a name.

**[Output Pattern]** Sets the power signal output mode.  
 EXT SW1: Pulse, EXT SW2: Level  
**"Pulse":** Generates a single power signal pulse.



**"Level":** Continues output of high power signal.

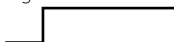

Sets to turn output on/off each time the button on the EXT SW Control screen is touched. See <External Device Power Supply Control> (page 48).

**[Pulse Set]** Sets the Pulse signal output time.

Outputs 500ms when "1" is set.

Increases by 200ms with each step. Up to 100 steps can be set.

### How To Use the Character Entry Screen



**[1]** Enters characters.

**[◀], [▶]** Shifts the cursor.

**[▲], [▼]** Scrolls up or down the character button display.

**[Shift]** Toggles between uppercase and lowercase.

**[qwe]/ [abc]** Sets the key layout of the character buttons.  
 abc : Alphabetical key layout.  
 qwe : Qwerty key layout.

**[Clear]** Clears the character.

**[Space]** Enters a space.  
 If you erase a character, locate the cursor on it and touch this button.



- You can enter characters only after you have applied the parking brake.

## Setup Memory

Audio Control, AV-IN SETUP, AV Interface, Navigation, and Audio SETUP settings can be memorized. The memorized settings can be recalled at any time. For example, even when the settings are cleared due to replacement of the battery, the settings can be restored.

### 1 Display the SETUP Memory screen

Touch [←] > [ ] > [System] > [SETUP Memory]. (page 68)

### 2 Start Setup Memory

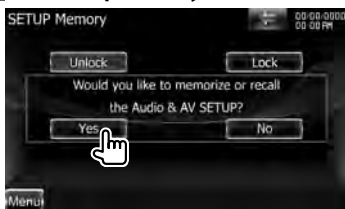

**[Lock]** Locks the AV-IN SETUP, Navigation, and Audio SETUP settings. When [Lock] is selected, you cannot change the AV-IN SETUP, Navigation, and Audio SETUP settings.

**[Yes]** Memorizes or recalls the settings.

**[No]** To cancel the function, touch [No]. To cancel memorization, touch [No]. The SETUP Menu screen appears again.

### 3 Select a desired function



**[Recall]** Recalls the memorized settings.

**[Memory]** Memorizes the current settings.

**[Clear]** Clears the currently memorized settings.

### 4 Memorize or recall the settings

**When memorizing the Audio Setup and AV Interface settings:**



If settings have already been memorized, a confirmation message appears. Touch [Yes]. To cancel memorization, touch [No].

**When recalling the memorized settings:**



Touching the screen displays a confirmation message. Touch [Yes]. To cancel recalling, touch [No].

**When clearing the currently memorized settings:**



Touching the screen displays a confirmation message. Touch [Yes]. To cancel clearing, touch [No].

### 5 Quit memorization/recalling of settings



## Changing Background image

Loads an image from the connected SD/USB device and sets it for the background image.

### 1 Connect the device which has the image to load

### 2 Display the Background screen

Touch [Left Arrow] > [Right Arrow] > [Display] > [Background]. (page 68)

### 3 Change Standby



### 4 Display the Background Memory screen



**[Change]** Selects an image for background.

**[Delete]** Deletes the background image. Touching the screen displays a confirmation message. Touch [Yes]. To cancel clearing, touch [No].

### 5 Select the image to load



### 6 Load the image



[↻] Rotates counter clockwise.

[↻] Rotates clockwise.

### 7 Select Background Change screen



### 8 Select an image for background



1 Returns to the initial background.

### 9 Set the image as the background



• See <About Picture files> (page 7) for readable image specifications.

- The [Memory] button on the "Background" screen becomes active only in STANDBY source mode.
- Pressing the [Memory] button on the "Background" screen switches the AV OUT source to OFF. For resetting the AV OUT source, refer to <AV Output Interface Setup> (page 83).

## Panel Color Coordinate

DNX9/ DDX8 series : Sets the button illumination color.

DNX7 series : Sets the screen and button illumination color.

### 1 Display the Color screen

Touch [←] > [?] > [Display] > [Color]. (page 68)

### 2 Display the Panel Color Coordinate screen

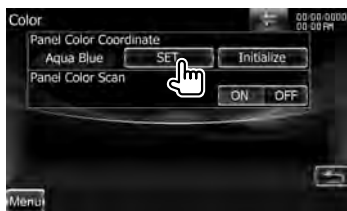

**[Initialize]** Initialization resets the settings made using the Panel Color to the default settings made at the factory.

**[Panel Color Scan]** When set to "ON", the illumination color of the screen and buttons changes one after another.



- When touching [SET] or [Initialize], make sure [Panel Color Scan] is set to "OFF".

### 3 Select a color



1 Sets to the touched color.

**[Adjust]** Sets and registers favorite color to the preset buttons ([P1] – [P3]).

### To register your original color

#### 1 Start the RGB coordinate



#### 2 Adjust each color value



1 Selects a preset number to register.

**[Red Value]** Adjusts the Red value.

**[Green Value]** Adjusts the Green value.

**[Blue Value]** Adjusts the Blue value.

#### 3 Select a Preset number to register



Adjusted color is registered to the selected Preset button.

#### 4 Complete the color coordination



## Screen Control

You can adjust the screen mode of the monitor.

#### 1 Display the Screen Control screen

Touch [←] > [Display] > [Screen Control]. (page 68)

#### 2 Set each item



**[Bright]** Brightness Control

**[Contrast]** Contrast Control

**[Black]** Black Level Adjustment

**[Dimmer]** Dimmer Mode Setup  
( "ON")

"ON": The display dims.

"OFF": The display doesn't dim.

"SYNC": Turning the Dimmer function On or Off when the vehicle light control switch is turned On or Off.

"NAV-SYNC": Turning the Dimmer function On or Off according to the Navigation Day/Night display setting. (DNX series and DDX series with navigation unit only)



- In this Screen Control screen, you can perform setups for the menu screen. Setups for videos such as DVD can be performed on the <Screen Control> (page 49).

## Registering Bluetooth Unit

Registers the Bluetooth unit to be connected.

### 1 Display the Bluetooth Setup screen

Touch [ ← ] > [ Bluetooth SETUP ]. (page 68)

### 2 Display the Connect Device List screen



### 3 Search for a Bluetooth unit



1 Displays the registered Bluetooth units.

[ ◀ ] When ◀ appears, the text display is scrolled by touching it.

[Search] Searches for a Bluetooth unit.

[SP DEV] Registers a Bluetooth unit that cannot be registered by normal register (paring) operation.



- A new device cannot be registered if there are 5 registered Bluetooth units. Delete unnecessary registration. See <Bluetooth Unit Connection> (page 81).

### 4 Display the PIN Code Set screen

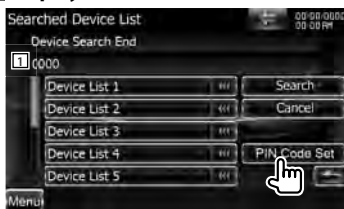

1 Display the PIN Code.

[Search] Searches for a Bluetooth unit.

[Cancel] Cancels searching of Bluetooth unit.

[PIN Code Set] Display the PIN Code Set screen.

### 5 Enter PIN code

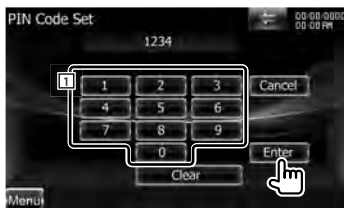

1 Enters a code number.

[Enter] Enter the PIN code specified for the Bluetooth unit to register.

This button will not be active until at least four PIN code digits have been entered.

[Cancel] Cancels registration of PIN code.

[Clear] Clears the code number.

### 6 Select the Bluetooth unit to register



- 1 Displays the searched Bluetooth unit. Returns to the Connect Device List screen.



- You can also register from the Bluetooth unit side. For the PIN code necessary for registration, see <Registering Bluetooth Unit PIN Code> (page 81).
- If pairing cannot be done even when the PIN code is correct, try <Registering Special Bluetooth Unit>.

### Registering Special Bluetooth Unit

Registers Special Bluetooth unit that results in error by normal operation by selecting from model name.

### 1 Display the Special Device List screen



### 2 Select a model name



Displays the Bluetooth unit name that can be registered.

### 3 Confirm whether to register

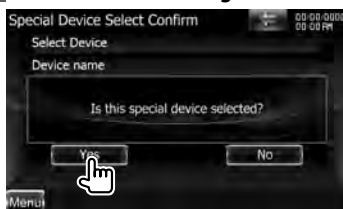

- Only models in Bluetooth unit name list can be registered.

### 4 Go through the procedure of <Registering Bluetooth Unit> and complete the registration (pairing)



## Registering Bluetooth Unit PIN Code

Sets the PIN code of the Bluetooth unit to enter when registering (pairing) from the cell-phone or audio player side.

### 1 Display the Bluetooth Setup screen

Touch [Left Arrow] > [Right Arrow] > [Bluetooth SETUP]. (page 68)

### 2 Display the Receiver PIN Code screen



### 3 Enter PIN code

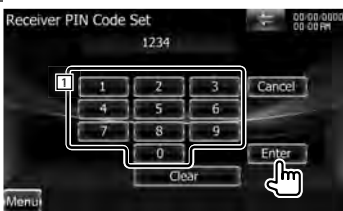

[1] Enters a code number.

[Cancel] Cancels registration of PIN code.

[Enter] Enters PIN code.

[Clear] Clears the code number.

## Bluetooth Unit Connection

Selects the Bluetooth unit to connect.

### 1 Display the Bluetooth Setup screen

Touch [Left Arrow] > [Right Arrow] > [Bluetooth SETUP]. (page 68)

### 2 Display the Connect Device List screen



### 3 Select a registered Bluetooth unit



### 4 Select the service to use



[TEL (HFP)] Connects/disconnects cell-phone to use for Hands Free.

[Audio (A2DP)] Connects/disconnects Audio player to use for Bluetooth Audio.

[Remove] Deletes registration (pairing). Touching the screen displays a confirmation message. Touch [Yes]. To cancel clearing, touch [No].

## Bluetooth Hands-Free/Audio Output Setup

Selects speakers to output the sound of hands-free phoning (such as phone call voice and ringing tone) and Bluetooth audio.

### 1 Display the Bluetooth Setup screen

Touch  >  > [Bluetooth SETUP]. (page 68)



**[Bluetooth HF/Audio]** Sets the output speakers. (☑ "Front Only")  
**"Front Only"**: Outputs from the front speakers.  
**"All"**: Outputs from all the speakers.

## AV Input Setup

You can set AV input parameters.

### 1 Display the AV-IN Setup screen

Touch  >  > [AV-IN SETUP]. (page 68)

### 2 Set each item



**[AV-IN Interruption]** Sets an image display of the system that is connected via the AV INPUT port. (☑ "OFF")  
**"OFF"**: When the image source is switched, an image entered via the AV INPUT port is displayed.  
**"ON"**: When an image signal is entered via the AV INPUT port, this image is displayed.

**[iPod AV Interface Use]** Sets the terminal which iPod is connected. (☑ "iPod")

**[AV-IN1 Name], [AV-IN2 Name], [AV-IN3 Name]** Sets a name to be displayed when you select a system that is connected via the AV INPUT port. (☑ "VIDEO")



- [iPod AV Interface Use]  
This item can be set when in STANDBY source and also the iPod is disconnected.
- [AV-IN Name]  
Two AV-IN names are displayed when "iPod" is selected in [iPod AV Interface Use] and three are displayed when not selected.
- [AV-IN3 Name]  
DNX9/ DDX8 series only

## AV Output Interface Setup

You can set AV output parameters.

### 1 Display the AV-OUT Interface screen

Touch   >  > [AV-OUT Interface]. (page 68)

### 2 Set each item



**[AV-OUT]** Selects an AV source to be output at the AV OUTPUT port.  
( "OFF")

## Camera Setup

You can set Camera parameters.

### 1 Display the Camera Setup screen

Touch   >  > [Camera SETUP]. (page 68)

### 2 Set each item



**[Rear Camera]** Selects the type of rear camera to use. ( "Other")  
"CMOS-300": When the CMOS-300 with ID 1 set is connected.  
"Other": When the other camera is connected.

**[R-CAM Interruption]** Sets a method to switch to the rear view camera video display. ( "OFF")

"ON": Switches to the rear view camera video display when engaging the shift knob of car to "Reverse".

"OFF": Switches to the rear view camera video display when engaging the shift knob of car to "Reverse" and then pressing the [AUD] button for longer than 1 second.

The function of the [AUD] button needs to be set to "CAM" in [AUD Key Longer than 1 Second] beforehand.

**[R-CAM Settings]** Adjusts the CMOS-300 with ID 1 set. For details, see the option manual.

## Setup Menu

**[Front Camera]** Turn this setting on when the CMOS-300 with ID2 set is connected. (☑ "OFF")

**[F-CAM Settings]** Adjusts the CMOS-300 with ID 2 set. For details, see the option manual.

## Navigation Setup

You can set Navigation parameters.

### 1 Display the Navigation Setup screen

Touch  >  > [Navigation]. (page 68)

### 2 Set each item



**[NAV Interrupt Speaker]** Selects speakers used for voice guidance of the navigation system. (☑ "Front All")

"Front L": Uses the front left side speaker for voice guidance.

"Front R": Uses the front right side speaker for voice guidance.

"Front All": Uses both front speakers for voice guidance.

**[NAV Voice Volume]** Adjusts the volume for voice guidance of the navigation system.

(☑ DNX series: "25", DDX series: "21")

**[NAV Mute]** Mutes the volume of rear speakers during voice guidance of the navigation system. (☑ "ON")

When turned "ON", the volume level drops for voice guidance.

**[Navigation Input]** Selects a navigation system connection. (☑ "RGB") (DDX series only)

"RGB": Allows the Kenwood's Navigation System to connect via its interface cable.

"AV-IN": Allows a third-party navigation system to connect via the AV INPUT1 port.

"OFF": Must be used if no navigation system is connected. (The navigation display is cancelled when the AV source is switched.)

**[On Screen Navigation]** Sets an on-screen display of the navigation screen. (✔ "OFF") (DDX series only)

"Auto": Information is displayed for 5 seconds when updated. (Example : when the track/file/song has changed to the next one.)

"OFF": Information is not displayed.



- [On Screen Navigation]  
It can be set only when [Navigation Input] is set to "AVIN".

## DSP Bypass Control (DNX7 series)

Temporarily bypassing DSP (Digital Signal Processor) System.

### 1 Display the Audio SETUP screen

Touch [ ← ] > [ DSP ] > [Audio SETUP].  
(page 68)

### 2 Set the DSP Select



**[Bypass]** There is no effect by DSP.

**[Through]** There is an effect by DSP.



- When the mode is set to [Bypass], DSP System cannot be adjusted.

## Speaker Setup

You can select a speaker type and its size to get the best sound effects.

### 1 Display the Speaker Select screen

Touch [Left Arrow] > [Speaker Select] > [Audio SETUP] > [Speaker Select]. (page 68)

### 2 Select a speaker you wish to adjust

When the speaker type and size are set, the speaker crossover network and equalizer curve are set automatically.



- 1 Center speaker (DNX9/ DDX8 series)
- 2 Front speaker
- 3 Rear speaker
- 4 Subwoofer

**[Tweeter]** You can set the tweeter when you are selecting front speakers.

If you are using a tweeter together with the front speakers, set the tweeter to "ON". In the "ON" position, the Equalizer is adjusted to its best position.

**[X'over]** Displays the Speaker Crossover Setup screen.

You can adjust the crossover setup that was set automatically when you selected the speaker type.

### 3 Select a speaker type



You can select any of the following speaker types.

- "Center"** None, 40x70 mm, 5 cm, 10 cm, 13 cm, 16 cm over
- "Front"** OEM, 10 cm, 13 cm, 16 cm, 17 cm, 18 cm, 4x6, 5x7, 6x8, 6x9, 7x10
- "Rear"** None, OEM, 10 cm, 13 cm, 16 cm, 17 cm, 18 cm, 4x6, 5x7, 6x8, 6x9, 7x10
- "Subwoofer"** None, 16 cm, 20 cm, 25 cm, 30 cm, 38 cm over



- Select "None" if you have no speakers.
- If you set the center speaker to "None" even in a short time when you are setting the Surround Control to "Bypass+Center", the Surround Control is set to "Bypass" automatically. See <Surround Control> (page 67).
- If you set the center and rear speakers to "None" when you are setting the Surround Control to "Dolby PL II", the Surround Control is set to "Bypass" automatically. See <Surround Control> (page 67).

## Crossover Network Setup

You can set a crossover frequency of speakers.

### 1 Select the speaker to set the crossover



- 1 Sets the High Pass Filter of the center speaker. (DNX9/ DDX8 series)
- 2 Sets the High Pass Filter of the front speaker.
- 3 Sets the High Pass Filter of the rear speaker.
- 4 Sets the Low Pass Filter of the subwoofer.

### 2 Display the Crossover setup screen



### 3 Set the crossover



**[Phase]** Sets the phase of subwoofer output.

The phase is reversed 180 degrees when set to "Reverse". (Only when "Subwoofer" is set to any item other than "None" in Speaker Setup)

**[HPF FREQ]** High Pass Filter adjustment. (When front, center or rear speaker is selected on Speaker Select screen)

**[LPF FREQ]** Low Pass Filter adjustment. (When Subwoofer is selected on Speaker Select screen)

**[Slope]** Sets a crossover slope.

## Car Type (DTA) Setup

You can setup the car type and speaker network, etc.

### 1 Display the Car Type Setup screen

Touch > > [Audio SETUP] > [Car Type]. (page 68)

### 2 Setup the Car Type

If your car type is selected, the Digital Time Alignment and Equalizer is set automatically (for timing adjustment of sound output for each channel) to have the highest surround effects.

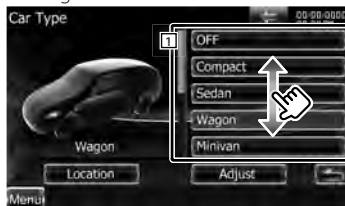

1 Sets up the car type you use together with this unit.

You can choose according to type of your car.

"OFF", "Compact", "Sedan", "Wagon", "Minivan", "SUV", "Passenger van"

**[Location]** Sets the locations of the speakers.

**[Adjust]** Displays the Car Type Adjust screen.

You can adjust the digital time alignment that was set automatically when you selected the car type.

### Speaker Location setup

#### 1 Display the Speaker Location Setup screen



#### 2 Set the speaker locations



**[Front Speaker]** Sets the location of the front speaker.

"Door", "On Dash", "Under Dash"

**[Rear Speaker]** Sets the location of the rear speaker.

"Door", "Rear Deck"

"2nd Row", "3rd Row" (Minivan, Passenger van)

### Car Type Adjust

You can manually set the sound output timing of each channel.

#### 1 Display the Car Type Adjust screen



#### 2 Select a speaker you wish to adjust

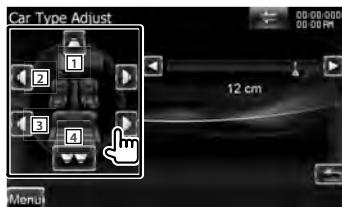

1 Center speaker (DNX9/ DDX8 series)

2 Front speaker

3 Rear speaker

4 Subwoofer

#### 3 Set a delay time



Make fine adjustment of the delay time of the speaker output specified at <Setup the Car Type> to have a more suitable environment for your vehicle.

The settings of the delay time are automatically identified and compensated by specifying the distances of each speaker from the center of the vehicle interior.

1 Set the front and rear positions and the height of the reference point to the position of the ears of the person



sitting in the front seat, and set the right and left positions to the center of the vehicle interior.

- 2 Measure the distances from the reference point to the speakers.
- 3 Calculate the distance difference in accordance with the farthest speaker.

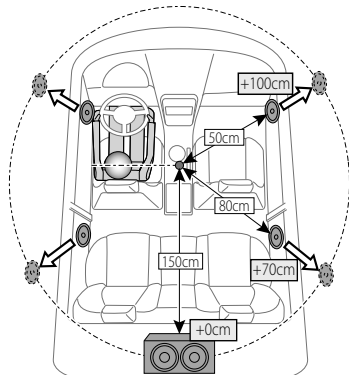

## Channel Level (DNX9/ DDX8 series)

You can set the volume at each setup position.

### 1 Display the Car Type Setup screen

Touch [ ← ] > [ 🚗 ] > [Audio SETUP]  
> [Channel Level]. (page 68)

### 2 Select a speaker you wish to adjust

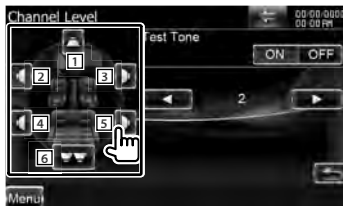

- 1 Center speaker
- 2 Left front speaker
- 3 Right front speaker
- 4 Left rear speaker
- 5 Right rear speaker
- 6 Subwoofer

**[Test Tone]** Starts or stops test signal tone output for setup check.

### 3 Adjust the volume



### DVD Setup

You can set up the DVD play.

#### 1 Display the DVD Setup screen

Touch    > [DVD SETUP].  
(page 68)

#### 2 Set each item



**[Menu Language]\*1** Selects a disc menu language. See <DVD Language Setup> (page 90).

**[Subtitle Language]\*1** Selects a subtitle language. See <DVD Language Setup> (page 90).

**[Audio Language]\*1** Selects an audio language. See <DVD Language Setup> (page 90).

**[Dynamic Range Control]\*1** Sets the dynamic range. ( "Dialog") The dynamic range is reduced by changing from "Wide" to "Normal" and from "Normal" to "Dialog". "Dialog" makes the total sound volume becomes larger as compared with "Wide" and "Normal", allowing you to listen to the movie's dialog more clearly. This is effective only when you are using

a Dolby Digital software. The operation is available during the play stop mode.

**[Angle Mark]** Sets an angle mark display. () "ON")

**[Screen Ratio]\*1** Selects the screen display mode. () "16:9")

"16:9": Displays wide pictures.

"4:3 LB": Displays wide pictures in the Letter Box format (having black stripes at the top and bottom of screen).

"4:3 PS": Displays wide pictures in the Pan & Scan format (showing pictures cut at the right and left ends).

**[Parental Level]\*1** Displays the Parental Lock screen. () "OFF")

See <DVD Parental Level Setup> (page 91).

**[Disc SETUP]** Makes the settings related to the disc media. See <Disc Setup> (page 92).

**[Stream Information]** Displays the present source information. The stream (Dolby Digital, dts, Linear PCM, MPEG, MP3, WMA or AAC) is displayed. (DNX7 series only)



\*1 Disabled when a DVD is being played.

### DVD Language Setup

Selects a language you use for the speech and menus.

#### 1 Display the DVD Setup screen

Touch    > [DVD SETUP].  
(page 68)

## 2 Select the language item to set



## 3 Enter a language code

See <DVD Language Codes> (page 106) and select the desired language.

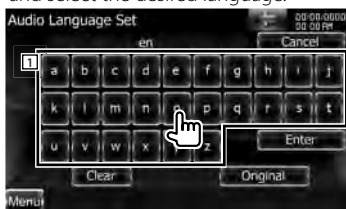

**1** Enters a language code.

**[Cancel]** Cancels the language setup and returns to the "DVD SETUP" screen.

**[Enter]** Sets the language and returns to the "DVD SETUP" screen. (It appears after you have entered a language code.)

**[Original]** Sets the DVD's original language (only when setting an audio language).

**[Clear]** Clears the language code.

## 4 Set the language you use



## DVD Parental Level Setup

Sets a parental level.

### 1 Display the DVD Setup screen

Touch > [DVD SETUP]. (page 68)

### 2 Display the Parental Level code number screen



### 3 Enter the code number



**1** Enters a code number.

**[Cancel]** Cancels the current setup and returns to the "DVD SETUP" screen.

**[Level]** Indicates the present parental lock level.

**[Enter]** Determines the code number and displays the Parental Level setup screen.

**[Clear]** Clears the code number.



- The number you enter first is set as your code number.

### 4 Display the Parental Level SETUP screen



### 5 Select a parental level and complete the setup

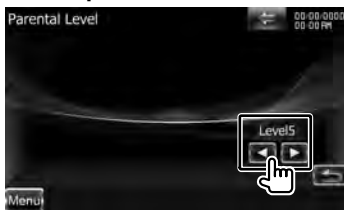

Selects a parental level.



- If a disc has higher parental lock level, you need to enter the code number.
- The parental lock level varies depending on a loaded disc.
- If a disc has no parental lock, anybody can play it back even when you have set the parental lock.

## Disc Setup

Performs setup when using disc media.

### 1 Display the DVD Setup screen

Touch [Left] > [Right] > [DVD SETUP].  
(page 68)

### 2 Display the Disc Setup screen

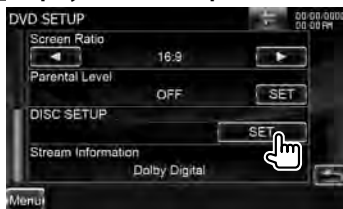

### 3 Set each item



**[CD Read]** Sets a music CD playback.

( "1")

"1": Automatically recognizes and plays back an Audio file disc, a DVD or a music CD.

"2": Forcibly plays back a disc as a music CD. Select "2" if you wish to play a music CD having a special format or if you cannot play a disc in the "1" position.

**[On Screen DVD]** Sets an on-screen display of the DVD Playback screen.

( "OFF")

"Auto": Information is displayed for 5 seconds when updated.

"OFF": Information is not displayed.



- [CD Read]

Disabled when a disc is in the unit.

You cannot play an Audio file/VCD disc in the "2" position. Also, you may not play some music CDs in the "2" position.

## USB/ SD Setup

Performs setup when using USB or SD.

### 1 Display the USB/ SD Setup screen

Touch [←] > [USB/SD] > [USB SETUP] or [SD SETUP]. (page 68)

### 2 Set each item

Example : USB Setup screen



**[Picture Display Time]** Selects a picture display time. (📄 "Long")

The Display of a JPEG picture is changed. ("Short", "Middle", "Long")

**[On Screen USB]/ [On Screen SD]** Sets an on-screen display of the USB/ SD Playback screen. (📄 "Auto")

"Auto": Information is displayed for 5 seconds when updated.

"OFF": Information is displayed when you touch on the screen.

### iPod Setup

Performs setup when using iPod.

#### 1 Display the iPod Setup screen

Touch  >  > [iPod SETUP]. (page 68)

#### 2 Set each item



**[AudioBook Speed]** Sets the Audio book playback speed. (📌 "Normal")

**[Wide Screen]** Sets Wide Screen on or off. (📌 "OFF")

**[On Screen iPod]** Sets an on-screen display of the iPod Playback screen. (📌 "Auto")

"Auto": Information is displayed for 5 seconds when updated.

"OFF": Information is displayed when you touch on the screen.



- "Wide Screen" cannot be set while the iPod is connected.

### Tuner Setup

You can set Tuner related parameters.

#### 1 Display the Tuner Setup screen

Touch  >  > [TUNER SETUP]. (page 68)

#### 2 Set each item



**[NEWS]** Sets a news bulletin interrupt time. (📌 "OFF")

**[AF]\*1** When station reception is poor, automatically switches to the station that is broadcasting the same program over the same RDS network. (📌 "ON")

**[Regional]\*1** Sets whether to switch to the station only in the specific region using the "AF" control. (📌 "ON")

**[Auto TP Seek]\*1** When traffic information station reception is poor, automatically searches for a station that can be received better. (📌 "ON")

**[Language Select]** Selects a display language for the PTY function. (📌 "English (en)")



- \*1 Only when receiving the FM broadcast.

## TV Setup

The TV signal receiving areas can be set.  
(with the optional accessory TV Tuner  
connected only)

### 1 Display the TV SETUP screen

Touch [←] | [→] | [?] | [→] [TV SETUP].  
(page 68)

### 2 Set each item



**[On Screen TV]** Sets an on-screen display of the TV screen.  
( "Auto") (with the optional accessory TV tuner connected only)

"Auto": Information is displayed for 5 seconds when updated.

"OFF": Information is displayed when you touch on the screen.

### 3 Setting up TV (only with KTC-V301E/ KTC-V300E (optional accessory) connected)

Example : TV1 Area screen



Sets the present TV1 or TV2 receiving area.

# Remote Controller

This unit can be operated using the Remote Controller supplied with this unit.

## CAUTION

- Put the Remote Controller in a place where it will not move during braking or other operations. A dangerous situation could result, if the Remote Controller falls down and gets wedged under the pedals while driving.
- Do not leave the battery near fire or under direct sunlight. A fire, explosion or excessive heat generation may result.
- Do not recharge, short, break up or heat the battery or place it in an open fire. Such actions may cause the battery to leak fluid. If spilled fluid comes in contact with your eyes or on clothing, immediately rinse with water and consult a physician.
- Place the battery out of reach of children. In the unlikely event that a child swallows the battery, immediately consult a physician.

## Battery installation

Use two "AAA"/"R03"-size batteries. Insert the batteries with the + and – poles aligned properly, following the illustration inside the case.

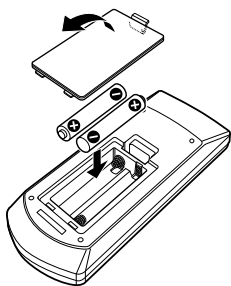

- If the Remote Controller operates only over shorter distances or does not operate at all, it is possible that the batteries are depleted. In such instances, replace the both batteries with new ones.

## Remote Controller mode switch

The functions operated from the remote controller differ depending on the position of the mode switch.

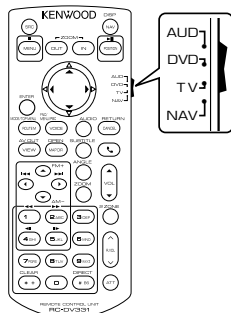

### AUD mode

Switch to this mode when controlling a selected source or tuner source, etc.

### DVD mode

Switch to this mode when playing DVDs or CDs etc. with the player integrated in this unit.



## TV mode

This is switched when controlling TV.

## NAV mode

This is switched when controlling Navigation unit.



- The position of the remote control mode switch is indicated in the title of each mode, e.g., "(AUD mode)".
- When controlling a player that is not integrated in the unit, select "AUD" mode.

## Common operations (AUD mode)

### Source switching

Switches to the source to be played.

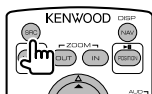

### Volume control

Adjusts the volume.

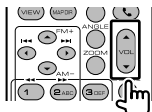

### Volume attenuator

Press the key once to lower the volume.  
Press again to restore the previous volume.

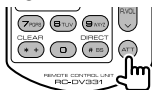

### Dual Zone

Switches the Dual Zone function ON and OFF.

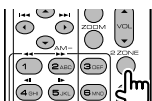

## Rear volume control

Adjusts volume at rear when the Dual Zone function is ON.

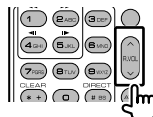

## NAV/V.SEL

Switches to the navigation screen.

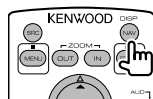

## Display angle

Switches the display angle each time it is pressed.



## Cursor key

Moves the cursor when displaying menu.



## ENTER

Enters options.

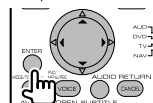

## Hands-free communication

When a call comes in, it answers the call.



## Function

Switches the function screen.



## MODE

Switches the screen mode.

Screen mode changes each time you press this key.

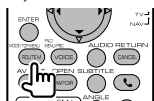

## DVD/VCD (DVD mode)

### Track search and file search

Selects the track or file to be played.

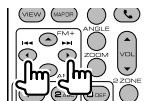

### Play/Pause

Pauses the track.

Press again to resume playing.

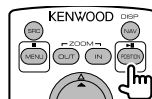

### Stop

Memorizes the last point where the disc stopped. When pressed again, the last point is deleted.

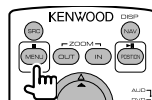

### Direct search

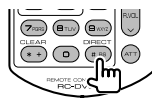

Pressing this key switches the features that can be searched directly.

### DVD-VIDEO

Title number

Chapter number

Play time

Item number\*

Cancel

\* You may not be able to use this function with some discs or scenes.

## VCD 1.X, VCD 2.X (PBC OFF)

Track number

Cancel

## VCD 2.X (PBC ON)

Scene number

Number

Cancel

Once you have switched to the direct search feature, specify the search number from the numeric keypad, and then press [ENTER] key.

### Numeric keypad

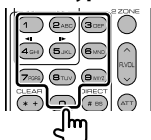

- Specify the number to search in direct search.
- Press **1** **2** to fast forward/backward. Switches the fast forward/backward speed each time you press this key.
- Press **4** **5** to slow forward/backward. Switches the slow playback speed each time you press this key.

### DVD Top Menu

Returns to the DVD top menu.

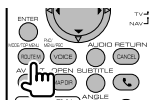

### DVD Menu

Displays the DVD menu.

Turns the playback control on or off while playing VCD.



### SUBTITLE

Switches the subtitle language.



### ZOOM

Switches the zoom ratio each time you press this key.

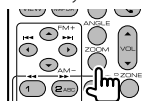

### Picture Angle

Switches the picture angle each time you press this key.

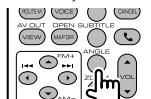

### AUDIO

Switches the voice language each time you press this key.



### Music CD/Audio file/Video file/ Picture file (AUD mode)

#### Folder search

Selects the folder to be played.

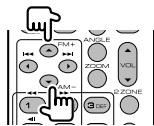

#### Track search and file search

Selects the track or file to be played.

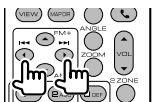

#### Play/Pause

Pauses the track or file.

Press again to resume playing.

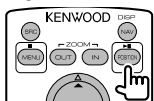

#### Direct search

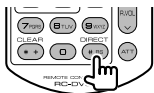

Pressing this key switches the features that can be searched directly.

#### Music CD

Track number

Play time

Cancel

#### Audio files in DVD/CD disc

Folder number

File number

Cancel

Once you have switched to the direct

search feature, specify the search number from the numeric keypad, and then press **[▶||]** key.

#### Numeric keypad

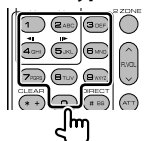

- Specify the number to search in direct search.

### iPod (AUD mode)

#### Music/Video search

Selects the music/video to be played.

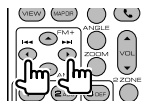

#### Play/Pause

Pauses the music/video.

Press again to resume playing.

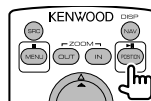

## Radio (AUD mode)

### FM band switching

Switches to bands received by the unit.

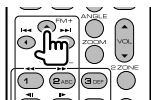

### AM band

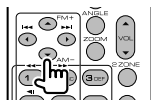

### Station selection

Switches to broadcast stations received by the unit.

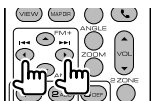

### Seek mode switching

Switches the Seek mode (AUTO1, AUTO2, MANU).

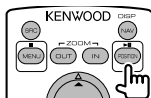

### Direct tuning

After pressing this key, use the keypad to specify the broadcast station you wish to receive.



Example: 92.1MHz (FM)

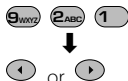

Example: 810kHz (AM)

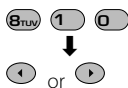

### Numeric keypad

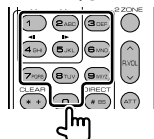

- To use preset tuning, press the number of a programmed broadcast station.  
(1 - 6MHz)
- Press the direct tuning key first, then specify the frequency of the station to receive.

## Navigation (NAV mode)

### Cursor key

Scrolls the map, or moves the cursor.

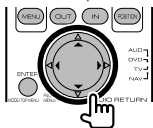

### ENTER

Performs the selected function.

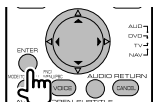

### ZOOM

Zooms in or out the navigation map.

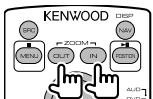

### MENU

Displays Main menu.

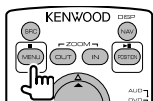

### CANCEL

Displays previous screen.

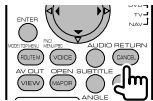

### POSITION

Displays the current position.

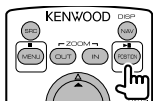

## ROUTE M

Displays Route Option menu.

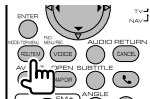

## VIEW

Switches between 2D and 3D map displays.



## VOICE

Plays Voice guidance.

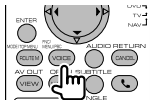

## MAP DIR

Switches between the heading up navigation and north up navigation map displays.



## TV (TV mode)

### Switching Band/Video

It switches between the station of the TV band to receive and video input.



### Channel Selection

The TV channel to receive is selected.

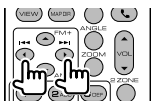

### Direct tuning (NTSC TV type only)



Press this key first, and then specify the station to receive with the numeric keypad.

Example: In case of Channel 6 (2-digit)

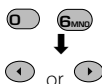

### Numeric keypad

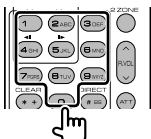

- The number of the memorized station is selected. ( **1** - **6** )
- Press the direct tuning key first, then specify the channel of the station to receive.

# Initial Setup

When pressing the Reset button or turning on the unit for the first time, the Initial SETUP screen is displayed.

## Initial Setup

### 1 Turns the power On

### 2 Set each item



**[Language]** Select the language used for the control screen and setting items. (page 70)

**[Angle]** You can adjust the position of the monitor. (page 73)

**[iPod AV Interface Use]** Sets the terminal which the iPod is connected to. (📁 "iPod")

**[Color]** Sets the screen and button illumination color. (page 77)

**[EXT SW]** Setting up external switch power mode. (page 74)

**[Camera]** You can set Camera parameters. See <Camera Setup> (page 83).

### 3 End initial setup



- The settings above can be changed in <Setup Menu> (page 68).



# Status bar Indicator items

Shown below is a list of indicators displayed on the Status bar.



Source	Display	Overview
General	"ATT"	Indicates that the attenuator is active.
	"DUAL"	Turns on the Dual zone function.
DVD/CD	"TEL"	Indicates the connection state of the Bluetooth hands-free unit. (White: Connected. Orange: Not connected.)
	"FO-REP"	Indicates that the Folder repeat function is ON.
	"IN"	Indicates that a disc is inserted. (White: A Disc is inside the unit. Orange: Error at the disc player.)
DVD - Video	"VIDEO"	Identifies the video file.
	"MUSIC"	Identifies the music file.
	"RDM"	Indicates that the Random function is ON.
	"REP"	Indicates that the Repeat function is ON.
	"C-REP"	Indicates that the Chapter repeat function is ON.
	"T-REP"	Indicates that the Title repeat function is ON.
	"1chLL"	Identifies the left audio output of channel 1.
	"1chLR"	Identifies the monaural audio output of channel 1.
	"1chRR"	Identifies the right audio output of channel 1.
	"1chST"	Identifies the stereo audio output of channel 1.
	"LL"	Identifies the left audio output.
	"LR"	Identifies the monaural audio output.
	"RR"	Identifies the right audio output.
	"ST"	Identifies the stereo audio output.
	"PBC"	Indicates that the PBC function is ON.
	"SVCD"	Identifies the Super Video CD.
	"VER1"	Indicates that the Video CD version is 1.
"VER2"	Indicates that the Video CD version is 2.	
"REP"	Indicates that the Repeat function is ON.	
USB/SD	"FO-REP"	Indicates that the Folder repeat function is ON.
	"VIDEO"	Identifies the video file.
	"MUSIC"	Identifies the music file.
	"PICTURE"	Identifies the image file.
	"RDM"	Indicates that the Random function is ON.
	"REP"	Indicates that the Repeat function is ON.
"PLST"	Indicates that the Play list mode is selected now.	

Source	Display	Overview
Pop	"MUSIC"	Identifies the music file.
	"VIDEO"	Identifies the video file.
	"RDM"	Indicates that the Random function is ON.
	"A-RDM"	Indicates that the Album random function is ON.
	"REP"	Indicates that the Repeat function is ON.
Tuner	"AF"	Indicates that the AF search function is ON.
	"AUTO1"	Indicates that Seek mode is set to Auto1.
	"AUTO2"	Indicates that Seek mode is set to Auto2.
	"EON"	Indicates that the RDS station is sending EON.
	"LO.S"	Indicates that the Local seek function is ON.
	"MANU"	Indicates that Seek mode is set to Manual.
	"MONO"	Indicates that the forced monaural function is ON.
	"NEWS"	Indicates that news bulletin interruption is in progress.
	"RDS"	Indicates the state of the RDS station when the AF function is ON. (White: RDS is being received. Orange: RDS is not being received.)
	"ST"	Indicates that stereo broadcast is being received.
TV	"TI"	Indicates the reception state of traffic information. (Orange: TP is not being received. White: TP is being received.)
	"AUTO1"	Indicates that Seek mode is set to Auto1.
TV	"AUTO2"	Indicates that Seek mode is set to Auto2.
	"MANU"	Indicates that Seek mode is set to Manual.

## DVD Language Codes

Code	Language
aa	Afar
ab	Abkhazian
af	Afrikaans
am	Amharic
ar	Arabic
as	Assamese
ay	Aymara
az	Azerbaijani
ba	Bashkir
be	Byelorussian
bg	Bulgarian
bh	Bihari
bi	Bislama
bn	Bengali, Bangla
bo	Tibetan
br	Breton
ca	Catalan
co	Corsican
cs	Czech
cy	Welsh
da	Danish
de	German
dz	Bhutani
el	Greek
en	English
eo	Esperanto
es	Spanish
et	Estonian
eu	Basque
fa	Persian
fi	Finnish
fj	Fiji
fo	Faroese
fr	French
fy	Frisian
ga	Irish
gd	Scots Gaelic
gli	Galician
gn	Guarani
gu	Gujarati
ha	Hausa
he	Hebrew
hi	Hindi
hr	Croatian
hu	Hungarian
hy	Armenian
ia	Interlingua

Code	Language
ie	Interlingue
ik	Inupiak
id	Indonesian
is	Icelandic
it	Italian
ja	Japanese
jv	Javanese
ka	Georgian
kk	Kazakh
kl	Greenlandic
km	Cambodian
kn	Kannada
ko	Korean
ks	Kashmiri
ku	Kurdish
ky	Kirghiz
la	Latin
lb	Luxembourgish
ln	Lingala
lo	Laotian
lt	Lithuanian
lv	Latvian, Lettish
mg	Malagasy
mi	Maori
mk	Macedonian
ml	Malayalam
mn	Mongolian
mo	Moldavian
mr	Marathi
ms	Malay
mt	Maltese
my	Burmese
na	Nauru
ne	Nepali
nl	Dutch
no	Norwegian
oc	Occitan
om	(Afan) Oromo
or	Oriya
pa	Punjabi
pl	Polish
ps	Pashto, Pushto
pt	Portuguese
qu	Quechua
rm	Rhaeto-Romance
rn	Kirundi
ro	Romanian

Code	Language
ru	Russian
rw	Kinyarwanda
sa	Sanskrit
sd	Sindhi
sg	Sangho
sh	Serbo-Croatian
si	Singhalese
sk	Slovak
sl	Slovenian
sm	Samoan
sn	Shona
so	Somali
sq	Albanian
sr	Serbian
ss	Siswati
st	Sesotho
su	Sundanese
sv	Swedish
sw	Swahili
ta	Tamil
te	Telugu
tg	Tajik
th	Thai
ti	Tigrinya
tk	Turkmen
tl	Tagalog
tn	Setswana
to	Tongan
tr	Turkish
ts	Tsonga
tt	Tatar
tw	Twi
uk	Ukrainian
ur	Urdu
uz	Uzbek
vi	Vietnamese
vo	Volapuk
wo	Wolof
xh	Xhosa
yo	Yoruba
zh	Chinese
zu	Zulu

## Help? Troubleshooting

---

Some functions of this unit may be disabled by some settings made on this unit.

- !** • Cannot set up the subwoofer.
- Cannot set up subwoofer phase.
- No output from the subwoofer.
- Cannot set up the low pass filter.
- Cannot set up the high pass filter.

- ▶ Subwoofer is not set to On.  
☞ <Speaker Setup> (page 86)

- ▶ The Dual zone function is enabled.  
☞ <Zone Control> (page 64)

---

- !** • Cannot select the output destination of the subsource in the Dual zone.
- Cannot adjust the volume of the rear speakers.

- ▶ The Dual zone function is disabled.  
☞ <Zone Control> (page 64)

---

- !** Cannot play audio files.

- ▶ "CD Read" of <Disc Setup> (page 92) is set to "2".

---

- !** Cannot Folder select.

- ▶ The Random play function is enabled.

---

- !** Cannot perform Repeat play.

- ▶ The PBC function of the Video CD is enabled.

---

- !** • Cannot set up the equalizer.
- Cannot set up the crossover network.

- ▶ The Dual zone function is enabled.  
☞ <Zone Control> (page 64)

- ▶ The DSP Select is Bypass.  
☞ <DSP Bypass Control> (page 85)

---

What might seem to be a malfunction in your unit may just be the result of slight misoperation or miswiring. Before calling service, first check the following table for possible problems.

### General

- ?** The Touch Sensor Tone doesn't sound.

- ✓ The preout jack is being used.
- ☞ The Touch Sensor Tone can't be output from the preout jack.

---

### Tuner source

- ?** Radio reception is poor.

- ✓ The car antenna is not extended.  
☞ Pull the antenna out all the way.
- ✓ The antenna control wire is not connected.  
☞ Connect the wire correctly, referring to the section on <INSTALLATION MANUAL>.

---

### Disc source

- ?** The specified disc does not play, but another one plays instead.

- ✓ The specified CD is quite dirty.  
☞ Clean the CD.
- ✓ The disc is severely scratched.  
☞ Try another disc instead.

---

### Audio file source

- ?** The sound skips when an Audio file is being played.

- ✓ The media is scratched or dirty.  
☞ Clean the media, referring to the CD cleaning of the section on <Handling discs> (page 4).
- ✓ The recording condition is bad.  
☞ Record the media again or use another media.

---

## Help? Error

---

**When the unit fails to operate correctly, the cause of the failure appears on the display.**

---

### **"Protect" :**

Protective circuit has been activated because a speaker cord has shorted or it has come in contact with the car chassis.

- ➔ Wire or insulate the speaker cord as appropriate and then push the Reset button.
- 

### **"Hot Error" :**

When the internal temperature of this unit rises to 60°C or more, the protection circuit is activated and you may not be able to operate the unit. At such times this message will appear.

- ➔ Use the unit again after reducing the temperature inside the vehicle.
- 

### **"Mecha Error" :**

The disc player is malfunctioning.

- ➔ Eject the disc and try inserting it again. Contact the Kenwood dealer if this indicator continues blinking or the disc cannot be ejected.
- 

### **"Disc Error" :**

An unplayable disc is inserted.

---

### **"Read Error" :**

Disc is quite dirty.

- ➔ Clean the disc, referring to the section on <Handling discs> (page 4). Disc is upside down.
  - ➔ Load the disc with the labeled side up.
- 

### **"Region code Error" :**

The disc you wanted to play has a region code that cannot be played with this unit.

---

### **"Parental level Error" :**

The disc you wanted to play has a higher level than the parental level you set.

---

### **"Error 07-67" :**

The unit is not operating correctly due to some reason or other.

- ➔ Push the unit's Reset button. If the "Error 07-67" message does not disappear, see your nearest Kenwood dealer.
- 

### **"No Device" (USB device):**

The USB device is selected as a source although no USB device is connected.

- ➔ Change the source to any source other than USB/iPod. Connect an USB device, and change the source to USB again.
- 

### **"Disconnected" (iPod, Bluetooth audio player):**

The iPod/Bluetooth audio player is selected as a source although no iPod/Bluetooth audio player is connected.

- ➔ Change the source to any source other than iPod/Bluetooth. Connect an iPod/Bluetooth audio player, and change the source to iPod/Bluetooth again.
- 

### **"No Music" :**

The connected USB device contains no playable audio file.

Media was played that doesn't have data recorded that the unit can play.

---

### **"USB Device Error!!" :**

The connected USB device is rated a current capacity higher than the allowable limit.

- ➔ Check the USB device. Some trouble may have occurred to the connected USB device.
  - ➔ Change the source to any source other than USB. Remove the USB device.
- 

### **"Authorization Error" :**

Connection to the iPod has failed.

- ➔ Remove the iPod and then reconnect it. The unit does not support the iPod.
  - ➔ Refer to <iPod/iPhone that can be connected to this unit> (page 7).
-

---

**"Update your iPod" :**

The iPod's software is an older version which the unit can not support.

- ➔ Confirm that the software for the iPod is the latest version. Refer to <iPod/iPhone that can be connected to this unit> (page 7).

---

**"You only can connect one iPod." :**

More than one iPod are connected to this unit.

- ➔ Connect only one iPod to the USB terminal with iPod tag.

---

**"Update your USB database" :**

The USB device is different from the previous one or the contained audio files are replaced.

- ➔ Update your database. Refer to <Source Control Screen> (page 26) of USB Device Control.

---

**"Navigation Error. Please turn on power again later." (DNX series only) :**

The communication error has occurred due to severely cold temperature.

- ➔ Turn on power again after warming your car interior.

---

**"No Navigation" (DDX series only):**

This unit does not support the connected navigation unit.

- ➔ The latest information on the connectable navigation unit can be obtained from <http://www.kenwood.com/cs/ce>.

No navigation unit is connected.

- ➔ Connect a supported navigation unit.

# Specifications

## Monitor section

### Picture Size

: 6.95 inches (diagonal) wide  
: 156.6 mm (W) x 81.6 mm (H)

### Display System

: Transparent TN LCD panel

### Drive System

: TFT active matrix system

### Number of Pixels

: 1,152,000 (800H x 480V x RGB)

### Effective Pixels

: 99.99 %

### Pixel Arrangement

: RGB striped arrangement

### Back Lighting

: LED

## DVD player section

### D/A Converter

: 24 bit

### Audio Decoder

: Linear PCM/ Dolby Digital/ dts/ MP3/ WMA/  
AAC

### Video Decoder

: MPEG1/ MPEG2/ DivX

### Wow & Flutter

: Below Measurable Limit

### Frequency Response

DNX9/ DDX8 series

Sampling frequency;  
96 kHz : 20 – 22,000 Hz  
48 kHz : 20 – 22,000 Hz  
44.1 kHz : 20 – 20,000 Hz

DNX7 series

Sampling frequency;  
96 kHz : 20 – 20,000 Hz  
48 kHz : 20 – 20,000 Hz  
44.1 kHz : 20 – 20,000 Hz

### Total Harmonic Distortion

: 0.008 % (1 kHz)

### S/N Ratio (dB)

: 98 dB (DVD-Video 96 kHz)

### Dynamic Range

: 98 dB (DVD-Video 96 kHz)

### Disc Format

: DVD-Video/ VIDEO-CD/ CD-DA

### Sampling Frequency

: 44.1/ 48/ 96 kHz

### Quantifying Bit Number

: 16/ 20/ 24 bit

## USB interface section

### USB Standard

: USB 2.0 High speed  
iPod: USB 1.1 Full speed (DNX9/ DDX8 series  
only)

### File System

: FAT 16/ 32

### Maximum Power Supply Current

: 500 mA

### D/A Converter

: 24 Bit

### Video Decoder

: MPEG1/ MPEG2/ MPEG4/ H.264/ WMV

### Audio Decoder

: MP3/ WMA/ AAC/ WAV (Linear PCM)

## SD card section (DDX series only)

### Compatible SD card

: SD card, SDHC card, miniSD card, miniSDHC  
card, microSD card, microSDHC card

### File System

: FAT 16/ 32

### Capacity

: Maximum 32 GB

### Data Transfer Rate

: Maximum 12 Mbps

### Video Decoder

: MPEG1/ MPEG2/ MPEG4/ H.264/ WMV

### Audio Decoder

: MP3/ WMA/ AAC/ WAV (Linear PCM)

## Bluetooth section

### Technology

: Bluetooth Ver.2.1 + EDR Certified

### Frequency

: 2.402 – 2.480 GHz

### Output Power

: +4dBm (MAX), 0dBm (AVE), Power Class2

### Maximum Communication range

: Line of sight approx. 10m (32.8 ft)

### Profile

HFP (Hands Free Profile),  
SPP (Serial Port Profile),  
HSP (Headset Profile),  
OPP (Object Push Profile),  
PBAP (Phonebook Access Profile),  
SYNC (Synchronization Profile),  
A2DP (Advanced Audio Distribution Profile),  
AVRCP (Audio/Video Remote Control Profile)

## FM tuner section

### Frequency Range (50 kHz)

: 87.5 MHz – 108.0 MHz

### Usable Sensitivity (S/N : 26 dB)

: 0.9  $\mu$ V/ 75  $\Omega$  (DNX9/ DNX7 series)  
: 0.7  $\mu$ V/ 75  $\Omega$  (DDX8 series)

### Quieting Sensitivity (S/N : 46 dB)

: 2.0  $\mu$ V/ 75  $\Omega$  (DNX9/ DNX7 series)  
: 1.6  $\mu$ V/ 75  $\Omega$  (DDX8 series)

### Frequency Response ( $\pm$ 3.0 dB)

: 30 Hz – 15 kHz

### S/N Ratio (dB)

: 70 dB (MONO)

### Selectivity ( $\pm$ 400 kHz)

:  $\geq$  80 dB

### Stereo Separation

: 35 dB (1 kHz)

## LW tuner section

### Frequency Range (9 kHz)

: 153 kHz – 279 kHz

### Usable Sensitivity

: 45  $\mu$ V

## MW tuner section

### Frequency Range (9 kHz)

: 531 kHz – 1611 kHz

### Usable Sensitivity

: 25  $\mu$ V

## Audio section

### Maximum Power (Front & Rear)

: 50 W x 4

### Full Bandwidth Power (Front & Rear)

(PWR DIN 45324, +B=14.4V)

: 30 W x 4

### Preout Level (V)

: 5 V/ 10 k $\Omega$  (DNX9/ DDX8 series)  
: 2 V/ 10 k $\Omega$  (DNX7 series)

### Preout Impedance

: 80  $\Omega$  (DNX9/ DDX8 series)  
:  $\leq$  600  $\Omega$  (DNX7 series)

### Speaker Impedance

: 4 – 8  $\Omega$

## Video section

### Color System of External Video Input

: NTSC, PAL

### External Video Input Level (mini jack)

: 1 Vp-p/ 75  $\Omega$

### External Audio Max Input Level (mini jack)

: 2 V/ 25 k $\Omega$

### Video Output Level (RCA jacks)

: 1 Vp-p/ 75  $\Omega$

### Audio Output Level (RCA jacks)

: 1.2 V/ 10 k $\Omega$

### Analog RGB input (DDX series only)

: 0.7 Vp-p/ 75  $\Omega$

## Specifications

### DSP Section

#### Graphics equalizer

DNX9/ DDX8 series

Band: 13 Band

Frequency (BAND1 – 13)

: 62.5/ 100/ 160/ 250/ 400/ 630/ 1k/ 1.6k/  
2.5k/ 4k/ 6.3k/ 10k/ 16k Hz

Channel: Front/ Rear/ Center

DNX7 series

Band: 5 Band

Frequency (BAND1 – 5)

: 62.5/ 250/ 1k/ 4k/ 16k Hz

#### Gain

: -9/ -8/ -7/ -6/ -5/ -4/ -3/ -2/ -1/ 0/ 1/ 2/ 3/ 4/  
5/ 6/ 7/ 8/ 9 dB

#### X'over

##### High pass filter

Frequency: Through, 30/ 40/ 50/ 60/ 70/ 80/  
90/ 100/ 120/ 150/ 180/ 220/  
250 Hz

Slope: -6/ -12/ -18/ -24 dB

##### Low pass filter

Frequency: 30/ 40/ 50/ 60/ 70/ 80/ 90/ 100/  
120/ 150/ 180/ 220/ 250 Hz,  
Through

Slope: -6/ -12/ -18/ -24 dB

#### Time alignment

Front/ Rear/ Subwoofer

: 0 – 6.1 m (0.02 m Step)

Center: 0 – 3.4 m (0.02 m Step)  
(DNX9/ DDX8 series)

#### Position

: 0 – 1.7 m (0.02 m Step)

#### Channel Level (DNX9/ DDX8 series)

Front/ Rear/ Center :  $\pm 10$  dB

Subwoofer : -50 – +10 dB

#### Subwoofer level (DNX7 series)

: -50 – +10 dB

### Navigation section (DNX series only)

#### Receiver

: High-sensitivity GPS receiver

#### Reception Frequency

: 1575.42 MHz (C/A code)

#### Acquisition Times

Cold : < 38 seconds

Factory Reset : < 45 seconds

(On average for a stationary receiver with a clear view of the sky)

#### Accuracy

Position : < 10 meters typical

Velocity : 0.05 m/sec. RMS

#### Position Method

: GPS

#### Antenna

: External GPS antenna

### External SW

#### Maximum Power Supply Current

: 500 mA

### General

#### Operating voltage

: 14.4 V (10.5 – 16 V allowable)

#### Maximum Current Consumption

: 15 A

#### Dimensions (W × H × D)

: 182.7 × 100.0 × 180 mm

#### Operational Temperature Range

: -10 °C – +60 °C

#### Storage Temperature Range

: -20 °C – +85 °C

#### Weight

DNX9 series : 2.69 kg

DNX7 series : 2.65 kg

DDX series : 2.61 kg



---

Specifications subject to change without notice.

Although the effective pixels for the liquid crystal panel is given as 99.99% or more, 0.01% of pixels may not light or may light incorrectly.

## **ABOUT DIVX VIDEO:**

DivX® is a digital video format created by DivX, Inc. This is an official DivX Certified device that plays DivX video. Visit [www.divx.com](http://www.divx.com) for more information and software tools to convert your files into DivX video.

## **ABOUT DIVX VIDEO-ON-DEMAND:**

This DivX Certified® device must be registered in order to play DivX Video-on-Demand (VOD) content. To generate the registration code, locate the DivX VOD section in the device setup menu. Go to [vod.divx.com](http://vod.divx.com) with this code to complete the registration process and learn more about DivX VOD.

The Bluetooth word mark and logos are owned by the Bluetooth SIG, Inc. and any use of such marks by Kenwood Corporation is under license. Other trademarks and trade names are those of their respective owners.

The "AAC" logo is a trademark of Dolby Laboratories.

iPod is a trademark of Apple Inc., registered in the U.S. and other countries.

iPhone is a trademark of Apple Inc.

iTunes is a trademark of Apple Inc.

"Made for iPod" means that an electronic accessory has been designed to connect specifically to iPod and has been certified by the developer to meet Apple performance standards.

"Works with iPhone" means that an electronic accessory has been designed to connect specifically to iPhone and has been certified by the developer to meet Apple performance standards.

Apple is not responsible for the operation of this device or its compliance with safety and regulatory standards.

SDHC logo is a trademark.

DivX®, DivX Certified® and associated logos are registered trademarks of DivX, Inc. and are used under license.

 is a trademark of DVD Format/Logo Licensing Corporation registered in the U.S., Japan and other countries.

This product incorporates copyright protection technology that is protected by U.S. patents and other intellectual property rights. Use of this copyright protection technology must be authorized by Macrovision, and is intended for home and other limited viewing uses only unless otherwise authorized by Macrovision. Reverse engineering or disassembly is prohibited.

## **DNX9260BT/ DDX8026BT:**

 is a trademark of SRS Labs, Inc.

WOW technology is incorporated under license from SRS Labs, Inc.

Manufactured under license from Dolby Laboratories.

Dolby, Pro Logic and the double-D symbol are trademarks of Dolby Laboratories.

Manufactured under license under U.S. Patent #'s: 5,451,942; 5,956,674; 5,974,380; 5,978,762; 6,487,535 & other U.S. and worldwide patents issued & pending. DTS and the Symbol are registered trademarks & DTS Digital Surround and the DTS logos are trademarks of DTS, Inc. Product includes software. © DTS, Inc. All Rights Reserved.

## **DNX7260BT:**

Manufactured under license from Dolby Laboratories.

Dolby and the double-D symbol are trademarks of Dolby Laboratories.

Manufactured under license under U.S. Patent #'s: 5,451,942; 5,956,674; 5,974,380; 5,978,762; 6,487,535 & other U.S. and worldwide patents issued & pending. DTS and the Symbol are registered trademarks & DTS 2.0 Channel and the DTS logos are trademarks of DTS, Inc. Product includes software. © DTS, Inc. All Rights Reserved.

## The marking of products using lasers

**CLASS 1  
LASER PRODUCT**

The label is attached to the chassis/case and says that the component uses laser beams that have been classified as Class 1. It means that the unit is utilizing laser beams that are of a weaker class. There is no danger of hazardous radiation outside the unit.

## Information on Disposal of Old Electrical and Electronic Equipment and Batteries (applicable for EU countries that have adopted separate waste collection systems)

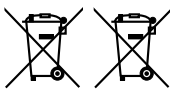

Products and batteries with the symbol (crossed-out wheeled bin) cannot be disposed of as household waste.

Old electrical and electronic equipment and batteries should be recycled at a facility capable of handling these items and their waste byproducts.

Contact your local authority for details in locating a recycle facility nearest to you.

Proper recycling and waste disposal will help conserve resources whilst preventing detrimental effects on our health and the environment.

Notice: The sign "Pb" below the symbol for batteries indicates that this battery contains lead.

**Pb**

This Product is not installed by the manufacturer of a vehicle on the production line, nor by the professional importer of a vehicle into an EU Member State.



This symbol mark indicates that Kenwood manufactured this product so as to decrease harmful influence on the environment.



**Declaration of Conformity with regard to the EMC Directive 2004/108/EC**

**Declaration of Conformity with regard to the R&TTE Directive 1999/5/EC**

**Manufacturer:**

Kenwood Corporation

2967-3 Ishikawa-machi, Hachioji-shi, Tokyo, 192-8525 Japan

**EU Representative's:**

Kenwood Electronics Europe BV

Amsterdamseweg 37, 1422 AC UITHOORN, The Netherlands

## English

Hereby, Kenwood declares that this unit DNX9260BT, DNX7260BT, DDX8026BT is in compliance with the essential requirements and other relevant provisions of Directive 1999/5/EC.

## Français

Par la présente Kenwood déclare que l'appareil DNX9260BT, DNX7260BT, DDX8026BT est conforme aux exigences essentielles et aux autres dispositions pertinentes de la directive 1999/5/CE.

Par la présente, Kenwood déclare que ce DNX9260BT, DNX7260BT, DDX8026BT est conforme aux exigences essentielles et aux autres dispositions de la directive 1999/5/CE qui lui sont applicables.

## Deutsch

Hiermit erklärt Kenwood, dass sich dieser DNX9260BT, DNX7260BT, DDX8026BT in Übereinstimmung mit den grundlegenden Anforderungen und den anderen relevanten Vorschriften der Richtlinie 1999/5/EG befindet. (BMW)

Hiermit erklärt Kenwood die Übereinstimmung des Gerätes DNX9260BT, DNX7260BT, DDX8026BT mit den grundlegenden Anforderungen und den anderen relevanten Festlegungen der Richtlinie 1999/5/EG. (Wien)

## Nederlands

Hierbij verklaart Kenwood dat het toestel DNX9260BT, DNX7260BT, DDX8026BT in overeenstemming is met de essentiële eisen en de andere relevante bepalingen van richtlijn 1999/5/EG.

Bij deze verklaart Kenwood dat deze DNX9260BT, DNX7260BT, DDX8026BT voldoet aan de essentiële eisen en aan de overige relevante bepalingen van Richtlijn 1999/5/EC.

## Italiano

Con la presente Kenwood dichiara che questo DNX9260BT, DNX7260BT, DDX8026BT è conforme ai requisiti essenziali ed alle altre disposizioni pertinenti stabilite dalla direttiva 1999/5/CE.

## Español

Por medio de la presente Kenwood declara que el DNX9260BT, DNX7260BT, DDX8026BT cumple con los requisitos esenciales y cualesquiera otras disposiciones aplicables o exigibles de la Directiva 1999/5/CE.

## Português

Kenwood declara que este DNX9260BT, DNX7260BT, DDX8026BT está conforme com os requisitos essenciais e outras disposições da Directiva 1999/5/CE.

## Polska

Kenwood niniejszym oświadcza, że DNX9260BT, DNX7260BT, DDX8026BT spełnia zasadnicze wymagania oraz inne istotne postanowienia dyrektywy 1999/5/EC.

## Český

Kenwood tímto prohlašuje, že DNX9260BT, DNX7260BT, DDX8026BT je ve shodě se základními požadavky a s dalšími příslušnými ustanoveními Nařízení vlády č. 426/2000 Sb.

## Magyar

Alulírott, Kenwood, kijelenti, hogy a jelen DNX9260BT, DNX7260BT, DDX8026BT megfelel az 1999/5/EC irányelvben meghatározott alapvető követelményeknek és egyéb vonatkozó előírásoknak.

## Svenska

Härmed intygar Kenwood att denna DNX9260BT, DNX7260BT, DDX8026BT står i överensstämmelse med de väsentliga egenskapskrav och övriga relevanta bestämmelser som framgår av direktiv 1999/5/EG.

## Suomi

Kenwood vakuuttaa täten että DNX9260BT, DNX7260BT, DDX8026BT tyyppinen laite on direktiivin 1999/5/EY oleellisten vaatimusten ja sitä koskevien direktiivin muiden ehtojen mukainen.

## Slovensko

S tem Kenwood izjavlja, da je ta DNX9260BT, DNX7260BT, DDX8026BT v skladu z osnovnimi zahtevami in ostalimi ustreznimi predpisi Direktive 1999/5/EC.

## Slovensky

Spoločnosť Kenwood týmto vyhlasuje, že DNX9260BT, DNX7260BT, DDX8026BT spĺňa základné požiadavky a ďalšie príslušné ustanovenia Direktívy 1999/5/EC.

## Dansk

Undertegnede Kenwood erklærer herved, at følgende udstyr DNX9260BT, DNX7260BT, DDX8026BT overholder de væsentlige krav og øvrige relevante krav i direktiv 1999/5/EF.

## Ελληνικά

ΜΕ ΤΗΝ ΠΑΡΟΥΣΑ Kenwood ΔΗΛΩΝΕΙ ΟΤΙ DNX9260BT, DNX7260BT, DDX8026BT ΣΥΜΜΟΡΦΟΝΕΤΑΙ ΠΡΟΣ ΤΙΣ ΟΥΣΙΩΔΕΙΣ ΑΠΑΙΤΗΣΕΙΣ ΚΑΙ ΤΙΣ ΛΟΙΠΕΣ ΣΥΣΤΗΚΕΣ ΔΙΑΤΑΞΕΙΣ ΤΗΣ ΟΔΗΓΙΑΣ 1999/5/ΕΚ.

## Esti

Sellega kinnitab Kenwood, et see DNX9260BT, DNX7260BT, DDX8026BT vastab direktiivi 1999/5/EC põhilistele nõudmistele ja muudele asjakohastele määrustele.

## Latviešu

Ar šo, Kenwood, apstiprina, ka DNX9260BT, DNX7260BT, DDX8026BT atbilst Direktīvas 1999/5/EK galvenajām prasībām un citiem tās nosacījumiem.

## Lietuviški

Šiuo, Kenwood, pareiškia, kad šis DNX9260BT, DNX7260BT, DDX8026BT atitinka pagrindinius Direktyvos 1999/5/EB reikalavimus ir kitas svarbias nuostatas.

## Malti

Hawnhekk, Kenwood, jiddikjara li dan DNX9260BT, DNX7260BT, DDX8026BT jikkonforma mal-htigijiet essenzjali u ma provvedimenti oħrajn relevanti li hemm fid-Direttiva 1999/5/EC.

## Українська

Компанія Kenwood заявляє, що цей виріб DNX9260BT, DNX7260BT, DDX8026BT відповідає ключовим вимогам та іншим пов'язаним положенням Директиви 1999/5/EC.