

# KENWOOD

## KDC-BT34U

CD-RECEIVER

### INSTRUCTION MANUAL

CD-RECEIVER

### BEDIENUNGSANLEITUNG

CD-РЕСИВЕР

### ИНСТРУКЦИЯ ПО ЭКСПЛУАТАЦИИ

JVCKENWOOD Corporation



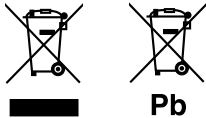

Pb

### Information on Disposal of Old Electrical and Electronic Equipment and Batteries (applicable for EU countries that have adopted separate waste collection systems)

Products and batteries with the symbol (crossed-out wheeled bin) cannot be disposed as household waste.

Old electrical and electronic equipment and batteries should be recycled at a facility capable of handling these items and their waste byproducts.

Contact your local authority for details in locating a recycle facility nearest to you. Proper recycling and waste disposal will help conserve resources whilst preventing detrimental effects on our health and the environment.

Notice: The sign "Pb" below the symbol for batteries indicates that this battery contains lead.

### Entsorgung von gebrauchten elektrischen und elektronischen Geräten und Batterien (anzuwenden in den Ländern der Europäischen Union und anderen europäischen Ländern mit einem separaten Sammelsystem für solche Geräte)

Das Symbol (durchgestrichene Mülltonne) auf dem Produkt oder seiner Verpackung weist darauf hin, dass dieses Produkt nicht als normaler Haushaltsabfall behandelt werden darf, sondern an einer Annahmestelle für das Recycling von elektrischen und elektronischen Geräten und Batterien abgegeben werden muss.

Durch Ihren Beitrag zur korrekten Entsorgung dieses Produktes schützen Sie die Umwelt und die Gesundheit Ihrer Mitmenschen.

Unschädlige oder falsche Entsorgung gefährden Umwelt und Gesundheit. Weitere Informationen über das Recycling dieses Produktes erhalten Sie von Ihrer Gemeinde oder den kommunalen Entsorgungsbetrieben.

Achtung: Das Zeichen „Pb“ unter dem Symbol für Batterien zeigt an, dass diese Batterie Blei enthält.

### For Israel

מידע בדבר השלכה לאשפה של ציוד חשמלי ואלקטרוני ישו וכן סוללות (רלוונטי למדינות ששמתשות במערכת איסוף אשפה מופרדת).

לא ניתן להשליך מוצרים וסוללות עם הסימון (פח אשפה עם X עליו) כאשפה ביתית רגילה. יש למחזר ציוד חשמלי ואלקטרוני ישו וכן סוללות במתקן המסוגל לטפל בפריטים כאלה ובתוצרי הלוואי שלהם. צרו קשר עם הרשות המקומית לקבלת פרטים אודות מתקן המיחזור הקרוב אליכם. מיחזור והשלכה לאשפה נאותים יעזרו לשמר משאבים ולמנוע השפעות שליליות על בריאותנו ועל הסביבה. שימו לב: הסימון Pb שמתחת לסימון עבור סוללות מצידן שהסוללה מכילה עופרת.

### For Turkey

Bu ürün 28300 sayılı Resmî Gazete’de yayımlanan Atık Elektrikli ve Elektronik Eşyaların Kontrolü Yönetmeliğe uygun olarak üretilmiştir.

### Eski Elektrik ve Elektronik Ekipmanların İmha Edilmesi Hakkında Bilgi (ayrı atık toplama sistemlerini kullanan ülkeleri için uygulanabilir)



Sembollü (üzerinde çarpı işareti olan çöp kutusu) ürünler ev atıkları olarak atılamaz.

Eski elektrik ve elektronik ekipmanlar, bu ürünleri ve ürün atıklarını geri dönüştürebilecek bir tesiste değerlendirilmelidir. Yaşadığımız bölgede en yakın geri dönüşüm tesisinin yerini öğrenmek için yerel makamlara müracaat edin. Uygun geri dönüşüm ve atık imha yöntemi sağlığımız ve çevremiz üzerindeki zararlı etkileri önlerken kaynakların korunmasına da yardımcı olacaktır.



### The marking of products using lasers

The label is attached to the chassis/case and says that the component uses laser beams that have been classified as Class 1. It means that the unit is utilizing laser beams that are of a weaker class. There is no danger of hazardous radiation outside the unit.

### Kennzeichnung von Geräten mit Laser-Abtastern

Das Etikett ist am Chassis/Gehäuse angebracht und besagt, dass sich die Komponente Laserstrahlen bedient, die als Laserstrahlen der Klasse 1 klassifiziert wurden. Dies weist darauf hin, dass sich das Gerät Laserstrahlen bedient, die einer schwächeren Klasse angehören. Das bedeutet, dass durch den sehr schwachen Laserstrahl keine Gefahr durch gefährliche Strahlungen außerhalb des Geräts besteht.

### Маркировка изделий, использующих лазеры

К корпусу устройства прикреплена табличка, указывающая, что устройство использует лазерные лучи класса 1. Это означает, что в устройстве используются лазерные лучи слабой интенсивности. Они не представляют опасности и не распространяют опасную радиацию вне устройства.



Дата изготовления (месяц/год) находится на этикетке устройства.

В соответствии с Законом Российской Федерации "О защите прав потребителей" срок службы (годности) данного товара "по истечении которого он может представлять опасность для жизни, здоровья потребителя, причинять вред его имуществу или окружающей среде" составляет семь (7) лет со дня производства. Этот срок является временем, в течение которого потребитель данного товара может безопасно им пользоваться при условии соблюдения инструкции по эксплуатации данного товара, проводя необходимое обслуживание, включающее замену расходных материалов и/или соответствующее ремонтное обеспечение в специализированном сервисном центре.

Дополнительные косметические материалы к данному товару, поставляемые вместе с ним, могут храниться в течение двух (2) лет со дня его производства.

Срок службы (годности), кроме срока хранения дополнительных косметических материалов, упомянутых в предыдущих двух пунктах, не затрагивает никаких других прав потребителя, в частности, гарантийного свидетельства KENWOOD, которое он может получить в соответствии с законом о правах потребителя или других законов, связанных с ним.

- "Made for iPod," and "Made for iPhone" mean that an electronic accessory has been designed to connect specifically to iPod, or iPhone, respectively, and has been certified by the developer to meet Apple performance standards. Apple is not responsible for the operation of this device or its compliance with safety and regulatory standards. Please note that the use of this accessory with iPod or iPhone may affect wireless performance.
- iPhone, iPod, iPod classic, iPod nano, and iPod touch are trademarks of Apple Inc., registered in the U.S. and other countries.
- Lightning is a trademark of Apple Inc.
- Android is trademark of Google Inc.
- The Bluetooth® word mark and logos are registered trademarks owned by Bluetooth SIG, Inc. and any use of such marks by JVC KENWOOD Corporation is under license. Other trademarks and trade names are those of their respective owners.

# CONTENTS

BEFORE USE	2
BASICS	3
GETTING STARTED	4
RADIO	5
AUX	6
CD / USB / iPod	6
BLUETOOTH®	8
AUDIO SETTINGS	13
DISPLAY SETTINGS	14
MORE INFORMATION	14
TROUBLESHOOTING	15
SPECIFICATIONS	16
INSTALLATION / CONNECTION	18

## How to read this manual

- Operations are explained mainly using buttons on the faceplate.
- [XX] indicates the selected items.
- (➔ XX) indicates references are available on the stated page.

# BEFORE USE

## ▲ Warning

Do not operate any function that takes your attention away from safe driving.

## ▲ Caution

### Volume setting:

- Adjust the volume so that you can hear sounds outside the car to prevent accidents.
- Lower the volume before playing digital sources to avoid damaging the speakers by the sudden increase of the output level.

### General:

- Avoid using the USB device or iPod/iPhone if it might hinder safe driving.
- Make sure all important data has been backed up. We shall bear no responsibility for any loss of recorded data.
- Never put or leave any metallic objects (such as coins or metal tools) inside the unit, to prevent a short circuit.
- If a disc error occurs due to condensation on the laser lens, eject the disc and wait for the moisture to evaporate.
- USB rating is indicated on the main unit. To view, detach the faceplate.

## Maintenance

**Cleaning the unit:** Wipe off dirt on the faceplate with a dry silicone or soft cloth.

**Cleaning the connector:** Detach the faceplate and clean the connector gently with a cotton swab, being careful not to damage the connector.

### Handling discs:

- Do not touch the recording surface of the disc.
- Do not stick tape etc. on the disc, or use a disc with tape stuck on it.
- Do not use any accessories for the disc.
- Clean from the center of the disc and move outward.
- Clean the disc with a dry silicone or soft cloth. Do not use any solvents.
- When removing discs from this unit, pull them out horizontally.
- Remove burrs from the center hole and disc edge before inserting a disc.

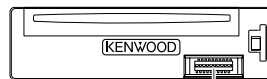

Connector (on the reverse side of the faceplate)

# BASICS

## Faceplate

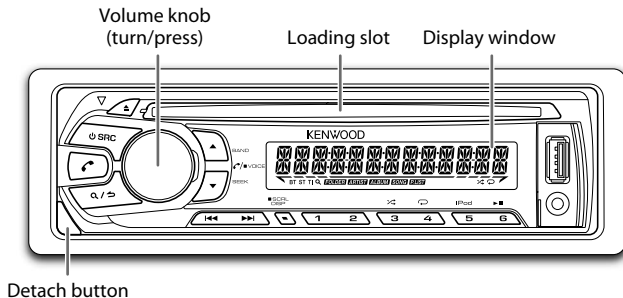

### Attach

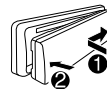

### Detach

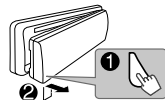

### How to reset

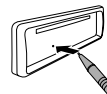

Your preset adjustments will also be erased.

To	Do this (on the faceplate)
Turn on the power	Press <b>⏻ SRC</b> . <ul style="list-style-type: none"><li>• Press and hold to turn off the power.</li></ul>
Adjust the volume	Turn the volume knob.
Select a source	Press <b>⏻ SRC</b> repeatedly.
Change the display information	Press <b>DISP SCRL</b> repeatedly. <ul style="list-style-type: none"><li>• Press and hold to scroll the current display information.</li></ul>

# GETTING STARTED

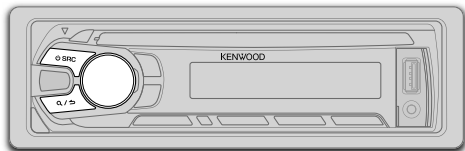

## 1 Select the display language and cancel the demonstration

When you turn on the power (or after you reset the unit), the display shows: "SEL LANGUAGE" → "PRESS" → "VOLUME KNOB"

- 1 Turn the volume knob to select [ENG] (English) or [RUS] (Russian), then press the knob.

[ENG] is selected for the initial setup.

Then, the display shows: "CANCEL DEMO" → "PRESS" → "VOLUME KNOB"

- 2 Press the volume knob.  
[YES] is selected for the initial setup.
- 3 Press the volume knob again.  
"DEMO OFF" appears.

## 2 Set the clock

- 1 Press the volume knob to enter [FUNCTION].
- 2 Turn the volume knob to select [CLOCK], then press the knob.
- 3 Turn the volume knob to select [CLOCK ADJUST], then press the knob.
- 4 Turn the volume knob to make the settings, then press the knob.  
Day → Hour → Minute
- 5 Turn the volume knob to select [CLOCK FORMAT], then press the knob.
- 6 Turn the volume knob to select [12H] or [24H], then press the knob.
- 7 Press and hold **Q/↵** to exit.

To return to the previous setting item or hierarchy, press **Q/↵**.

While in clock display screen...

Press and hold **DISP SCRL** to enter clock adjustment mode directly.  
Then, perform step 4 to set the clock.

## 3 Set the initial settings

- 1 Press **SRC** to enter STANDBY.
- 2 Press the volume knob to enter [FUNCTION].
- 3 Turn the volume knob to make a selection (see the following table), then press the knob.
- 4 Press and hold **Q/↵** to exit.

To return to the previous setting item or hierarchy, press **Q/↵**.

Default: **XX**

### AUDIO CONTROL

**SWITCH PREOUT** **REAR/ SUB-W**: Selects whether rear speakers or a subwoofer are connected to the line out terminals on the rear (through an external amplifier).

**SP SELECT** **OFF/ 5/4/ 6 × 9/6/ OEM**: Selects according to the speaker size (5 inches or 4 inches, 6×9 inches or 6 inches) or OEM speakers for optimum performance.

### TUNER SETTING

**PRESET TYPE** **NORMAL**: Memorizes one station for each preset button in each band (FM1/ FM2/ FM3/ MW/ LW). ; **MIX**: Memorizes one station for each preset button, regardless of the selected band.

### SYSTEM

**KEY BEEP** **ON**: Activates the keypress tone. ; **OFF**: Deactivates.

### SOURCE SELECT

**BUILT-IN AUX** **ON**: Enables AUX in source selection. ; **OFF**: Disables. (→ 6)

## GETTING STARTED RADIO

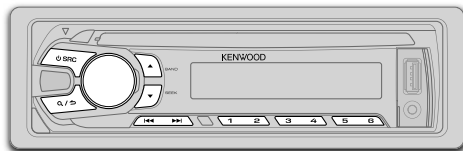

**RUSSIAN SET** Selects the display language for [FUNCTION] menu and Tag information (folder name, file name, song title, artist name, album name) if applicable.  
**RUSSIAN OFF:** Display language is English. ; **РУССКИЙ ВКЛ:** Display language is Russian.

**P-OFF WAIT** Applicable only when the demonstration mode is turned off.  
 Sets the duration when the unit will automatically turns off (while in standby mode) to save the battery.  
**20M:** 20 minutes ; **40M:** 40 minutes ; **60M:** 60 minutes ; **OFF** ---: Cancels

**CD READ** **1:** Automatically distinguishes between audio file disc and music CD. ; **2:** Forces to play as an music CD. No sound can be heard if an audio file disc is played.

### F/W UPDATE

#### UPDATE SYSTEM/ UPDATE BT

**F/W UP xx.xx** **YES:** Starts upgrading the firmware. ; **NO:** Cancels (upgrading is not activated).  
 For details on how to update the firmware, see:  
[www.kenwood.com/cs/ce/](http://www.kenwood.com/cs/ce/)

### Search for a station

- Press **SRC** to select **TUNER**.
- Press **▲ BAND** repeatedly to select **FM1/ FM2/ FM3/ MW/ (or LW)**.
- Press **◀◀ / ▶▶** to search for a station.
  - To change the searching method for ◀◀ / ▶▶:** Press **▼ SEEK** repeatedly.
    - AUTO1:** Automatically search for a station.
    - AUTO2:** Search for a preset station.
    - MANUAL:** Manually search for a station.
  - To store a station:** Press and hold one of the number buttons (**1** to **6**).
  - To select a stored station:** Press one of the number buttons (**1** to **6**).

### Other settings

- Press the volume knob to enter [FUNCTION].
- Turn the volume knob to make a selection (see the following table), then press the knob.
- Press and hold **Q / S** to exit.

To return to the previous setting item or hierarchy, press **Q / S**.

Default: **XX**

### TUNER SETTING

<b>LOCAL SEEK</b>	<b>ON:</b> Searches only FM stations with good reception. ; <b>OFF:</b> Cancels.
<b>AUTO MEMORY</b>	<b>YES:</b> Automatically starts memorizing 6 stations with good reception. ; <b>NO:</b> Cancels. (Selectable only if [NORMAL] is selected for [PRESET TYPE].) (↔4)
<b>MONO SET</b>	<b>ON:</b> Improves the FM reception, but the stereo effect may be lost. ; <b>OFF:</b> Cancels.
<b>NEWS SET</b>	<b>ON:</b> The unit will temporarily switch to News Programme if available. ; <b>OFF:</b> Cancels.
<b>REGIONAL</b>	<b>ON:</b> Switches to another station only in the specific region using the "AF" control. ; <b>OFF:</b> Cancels.
<b>AF SET</b>	<b>ON:</b> Automatically searches for another station broadcasting the same program in the same Radio Data System network with better reception when the current reception is poor. ; <b>OFF:</b> Cancels.
<b>TI</b>	<b>ON:</b> Allows the unit to temporarily switch to Traffic Information. ; <b>OFF:</b> Cancels.

## RADIO

**PTY SEARCH** Press the volume knob to enter PTY language selection. Turn the volume knob to select the PTY language (**ENGLISH/ FRENCH/ GERMAN**), then press the knob. Selects the available Program Type (see the following), then, press **◀◀ / ▶▶** to start.

### CLOCK

**TIME SYNC** **ON**: Synchronizes the unit's time to the Radio Data System station time.;  
**OFF**: Cancels.

- **[LOCAL SEEK]/ [MONO SET]/ [NEWS SET]/ [REGIONAL]/ [AF SET]/ [TI]/ [PTY SEARCH]** is selectable only when the band is FM1/ FM2/ FM3.

- Available Program Type:

**SPEECH**: NEWS, AFFAIRS, INFO (information), SPORT, EDUCATE, DRAMA, CULTURE, SCIENCE, VARIED, WEATHER, FINANCE, CHILDREN, SOCIAL, RELIGION, PHONE IN, TRAVEL, LEISURE, DOCUMENT

**MUSIC**: POP M (music), ROCK M (music), EASY M (music), LIGHT M (music), CLASSICS, OTHER M (music), JAZZ, COUNTRY, NATION M (music), OLDIES, FOLK M (music)

The unit will search for the Program Type categorized under **[SPEECH]** or **[MUSIC]** if selected.

- If the volume is adjusted during reception of traffic information, alarm or news bulletin, the adjusted volume is memorized automatically. It will be applied the next time traffic information, alarm or news bulletin function is turned on.

## AUX

**Preparation:**  
Select **[ON]** for **[BUILT-IN AUX]**. (→ 4)

### Start listening

- 1 Connect a portable audio player (commercially available).

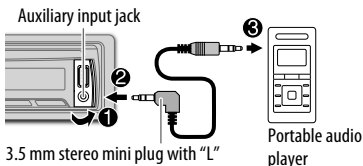

3.5 mm stereo mini plug with "L" shaped connector (commercially available)

- 2 Press **⏻ SRC** to select **AUX**.
- 3 Turn on the portable audio player and start playback.

### Set the AUX name

While listening to a portable audio player connected to the unit...

- 1 Press the volume knob to enter **[FUNCTION]**.
- 2 Turn the volume knob to select **[SYSTEM]**, then press the knob.
- 3 Turn the volume knob to select **[AUX NAME SET]**, then press the knob.
- 4 Turn the volume knob to make a selection, then press the knob.  
**AUX** (default) / **DVD** / **PORTABLE** / **GAME** / **VIDEO** / **TV**
- 5 Press and hold **⏻ / ⏪** to exit.

## CD / USB / iPod

### Start playback

The source changes automatically and playback starts.

### CD

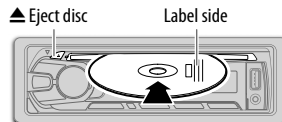

### USB

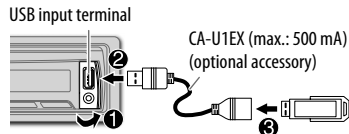

### iPod/iPhone

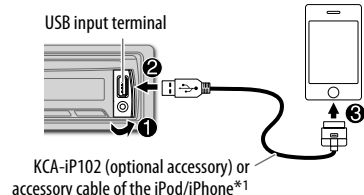

Press **5 iPod** to select the control mode while in iPod source.

**MODE ON**: From the iPod. (→ 7, \*2)

**MODE OFF**: From the unit.



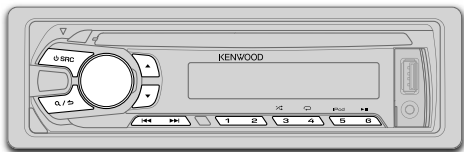

To	Do this
Pause or resume playback	Press <b>6</b> <b>II</b> .
Select a track/file	Press <b>1</b> <b>◀</b> / <b>▶</b> .
Select a folder <sup>*3</sup>	Press <b>▲</b> / <b>▼</b> .
Reverse/Fast-forward	Press and hold <b>1</b> <b>◀</b> / <b>▶</b> .
Repeat play <sup>*4</sup>	<p>Press <b>4</b> <b>↻</b> repeatedly.</p> <ul style="list-style-type: none"> <li>Audio CD: TRACK REPEAT, REPEAT OFF</li> <li>MP3/WMA/WAV file or iPod: FILE REPEAT, FOLDER REPEAT, REPEAT OFF</li> <li>KENWOOD Music Editor Light (KME Light)/ KENWOOD Music Control (KMC) file (➔ 14): FILE REPEAT, REPEAT OFF</li> </ul>
Random play <sup>*4</sup>	<p>Press <b>3</b> <b>↻</b> repeatedly.</p> <ul style="list-style-type: none"> <li>Audio CD: DISC RANDOM, RANDOM OFF</li> <li>MP3/WMA/WAV file or iPod or KME Light/ KMC file: FOLDER RANDOM, RANDOM OFF</li> </ul> <p>Press and hold <b>3</b> <b>↻</b> to select "ALL RANDOM". <sup>*5</sup></p>

<sup>\*1</sup> Do not leave the cable inside the car when not using.

<sup>\*2</sup> You can still play/pause, file skip, fast-forward or reverse files from the unit.

<sup>\*3</sup> Only for MP3/WMA/WAV files. This does not work for iPod.

<sup>\*4</sup> For iPod: Applicable only when [MODE OFF] is selected.

<sup>\*5</sup> For CD: Only for MP3/WMA files.

If you connect the iPod/iPhone to the USB input terminal of the unit (while listening to TuneIn Radio, TuneIn Radio Pro or Aupeo), the unit will output the sound from these apps.

### Select a track/file from a list

For iPod: Applicable only when [MODE OFF] is selected. (➔ 6)

- 1 Press **Q** / **↵**.
- 2 Turn the volume knob to make a selection, then press the knob.
  - MP3/WMA/WAV file: Select the desired folder, then a file.
  - iPod or KME Light/ KMC file: Select the desired file from the list (PLAYLISTS, ARTISTS, ALBUMS, SONGS, PODCASTS\*, GENRES, COMPOSERS\*).

\* Only for iPod.

- To return to the root folder (or first file), press number button **5 iPod**.
- To return to the previous setting item or hierarchy, press **Q** / **↵**.
- To cancel, press and hold **Q** / **↵**.

If you have many files...

You can search through them quickly (on step 2 above) at a preset skip search ratio by pressing **1** **◀** / **▶**.

- See also "Set the skip search ratio." (➔ 8)
- Pressing and holding **1** **◀** / **▶** skip songs at the maximum ratio (10%) regardless of the setting made.
- For USB: Only for files registered in the database created with KME Light/ KMC.
- Not applicable for audio CD.

### Select a song by name

While listening to iPod...

- 1 Press **Q / ↵**.
- 2 Turn the volume knob to select a category, then press the knob.
- 3 Turn the volume knob quickly to enter character search.
- 4 Turn the volume knob to select the character to be searched for.
- 5 Press **◀ / ▶** to move to the entry position.  
You can enter up to 3 characters.
- 6 Press the volume knob to start searching.
- 7 Turn the volume knob to make a selection, then press the knob.  
Repeat step 7 until the desired item is selected.

- To search for a character other than A to Z and 0 to 9, enter only “\*”.
- To return to the previous hierarchy, press **Q / ↵**.
- To return to the top menu, press number button **5 iPod**.
- To cancel, press and hold **Q / ↵**.

### Set the skip search ratio

While listening to iPod or KME Light/ KMC file...

- 1 Press the volume knob to enter [FUNCTION].
- 2 Turn the volume knob to select [USB], then press the knob.
- 3 Turn the volume knob to select [SKIP SEARCH], then press the knob.

- 4 Turn the volume knob to make a selection, then press the knob.  
0.5% (default)/ 1%/ 5%/ 10%: Skip search ratio over the total files.
- 5 Press and hold **Q / ↵** to exit.

### Change the USB drive

When a smartphone (Mass Storage Class) is connected to the USB input terminal, you can select its internal memory or external memory (such as an SD card) to playback the stored songs. You can also select the desired drive to playback when a multiple drives device is connected.

Press number button **5 iPod** repeatedly to select the desired drive.

(or)

- 1 Press the volume knob to enter [FUNCTION].
- 2 Turn the volume knob to select [USB], then press the knob.
- 3 Turn the volume knob to select [MUSIC DRIVE], then press the knob.
- 4 Press the volume knob to select [DRIVE CHANGE].

The next drive is selected automatically.  
Repeat steps 1 to 4 to select the following drives.

Selectable items: [DRIVE 1] to [DRIVE 5]

You can operate Bluetooth devices using this unit.

### Connect the microphone

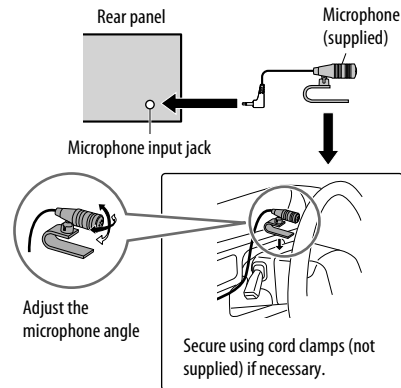

If you turn off the unit or detach the control panel during a phone call conversation, the Bluetooth connection is disconnected. Continue the conversation using your mobile phone.

### Supported Bluetooth profiles

- Hands-Free Profile (HFP)
- Serial Port Profile (SPP)
- Phonebook Access Profile (PBAP)
- Object Push Profile (OPP)
- Advanced Audio Distribution Profile (A2DP)
- Audio/Video Remote Control Profile (AVRCP)

### Pair a Bluetooth device

When connecting a Bluetooth device to the unit for the first time, perform pairing between the unit and the device. Once the pairing is completed, the Bluetooth device will remain registered in the unit even if you reset the unit.

- Up to five devices can be registered (paired) in total.
- A maximum of two Bluetooth phones and one Bluetooth audio device can be connected at any time.
- This unit supports Secure Simple Pairing (SSP).
- Some Bluetooth devices may not automatically connect to the unit after pairing. Connect the device to the unit manually. Refer to the instruction manual of the Bluetooth device for more information.

**1 Press  SRC to turn on the unit.**

**2 Search and select this unit model name (KDC-BT3\*U) on the Bluetooth device.**

"PAIRING" → "PASS XXXXXX" → Device name → "PRESS" → "VOLUME KNOB" scrolls on the display.

**3 Press the volume knob to start pairing.**

"PAIRING OK" appears when pairing is completed and "BT" will light up when the Bluetooth connection is established.

- For some Bluetooth devices, you may need to enter the Personal Identification Number (PIN) code immediately after searching.
  - Pairing request (via Bluetooth) is automatically activated if an iPhone/iPod touch is connected through the USB input terminal. (Applicable only if [AUTO PAIRING] is set to [ON].) (→ 12)
- Press the volume knob to pair once you have confirm the device name.

### Bluetooth test mode

You can check the connectivity of the supported profile between the Bluetooth device and the unit.

- Make sure there is no Bluetooth device connected.

**1 Press and hold .**

"PLEASE PAIR YOUR PHONE" appears.

**2 Search and select this unit model name (KDC-BT3\*U) on the Bluetooth device.**

**3 Operate the Bluetooth device to confirm pairing.**  
"TESTING" flashes on the display.

**The connectivity result (OK or NG) appears after the test.**

PAIRING: Pairing status







HF CNT: Hands-Free Profile (HFP) compatibility

AUD CNT: Advanced Audio Distribution Profile (A2DP) compatibility

PB DL: Phonebook Access profile (PBAP) compatibility

- To cancel check mode, press and hold  SRC to turn off the unit.

### Bluetooth mobile phone

To	Do this
Receive a call	Press  or the volume knob or one of the number buttons (1 to 6). • All the button illumination flash when there is an incoming call. • When [AUTO ANSWER] is set to the selected time, the unit answers incoming call automatically. (→ 11)
Reject an incoming call	Press  SRC.
End a call	Press  or  SRC.
Switch between hands-free and private talk modes	Press <b>6</b>  during a call. • Operations may vary according to the connected Bluetooth device.
Adjust the phone volume	<b>Turn the volume knob during a call.</b> Phone volume: [00] to [35] (Default: [15]) • This adjustment will not affect the volume of the other sources.
Switch between two connected phones	Press  repeatedly. • Not applicable during a call.

## BLUETOOTH®

### Improve the sound quality during a call

While talking on the phone...

- 1 Press the volume knob to enter [FUNCTION].
- 2 Turn the volume knob to make a selection (see the following table), then press the knob.
- 3 Press and hold  to exit.

To return to the previous setting item or hierarchy, press .

Default: **XX**

MIC GAIN	-20 — +8 (0): The sensitivity of the microphone increases as the number increased.
NR LEVEL	-5 — -20 (-10): Adjust the noise reduction level until the least noise is being heard during a phone conversation.
ECHO CANCEL	1 — 10 (4): Adjust the echo cancellation delay time until the least echo is being heard during a phone conversation.

### Text message notification

When the phone receives a text message, the unit rings and “SMS RECEIVED” appears.

- You cannot read, edit, or send a message through the unit.
- To clear the message, press any button.



### Use Voice Recognition

- 1 Press and hold .



The connected phone (which has been paired the earliest) is activated. However, if priority device is connected, pressing and holding  activate the priority device. (➔ 12, DVC PRIORITY)

- 2 Speak the name of the contact you want to call or the voice command to control the phone functions.
- Supported Voice Recognition features vary for each phone. Refer to the instruction manual of the connected phone for details.
  - This unit also supports the intelligent personal assistant function of iPhone.

### Bluetooth mode operations

- 1 Press  to enter Bluetooth mode.
- 2 Turn the volume knob to make a selection (see the following table), then press the knob.
- 3 Press and hold  to exit.

To return to the previous setting item or hierarchy, press .

CALL HISTORY	<ol style="list-style-type: none"><li>1 Press the volume knob to select a name or a phone number.<ul style="list-style-type: none"><li>• “I” indicates call received, “O” indicates call made, “M” indicates call missed.</li><li>• Press <b>DISP SCRL</b> to change the display category (NUMBER or NAME).</li><li>• “NO DATA” appears if there is no recorded call history.</li></ul></li><li>2 Press the volume knob to call.</li></ol>
PHONE BOOK	<ol style="list-style-type: none"><li>1 Turn the volume knob to select a name, then press the knob.</li><li>2 Turn the volume knob to select a phone number, then press the knob to call.<ul style="list-style-type: none"><li>• If the phone supports PBAP, the phonebook of the connected phone is automatically transferred to the unit when pairing. If the phone does not support PBAP, “TRANSFER PB” appears. Transfer the phonebook manually. (➔ 12, TRANSFER PB)</li><li>• Contacts are categorized as: MO (mobile), HM (home), OF (office), OT (others), GE (general)</li><li>• This unit can display only non-accent letters. (Accent letters such as “Ú” is shows as “U”.)</li><li>• If the phonebook contains many contacts, (➔ 11, Select a contact by name).</li></ul></li></ol>
NUMBER DIAL	<ol style="list-style-type: none"><li>1 Turn the volume knob to select a number (0 to 9) or character (*, #, +).</li><li>2 Press  /  to move the entry position. Repeat steps 1 and 2 until you finish entering the phone number.</li><li>3 Press the volume knob to call.</li></ol>
VOICE	Speak the name of the contact you want to call or the voice command to control the phone functions. (➔ Use Voice Recognition)

<b>BATT*</b>	<b>LOW/ MID/ FULL:</b> Shows the strength of the battery.
<b>SIGNAL*</b>	<b>NO SIGNAL/ LOW/ MID/ MAX:</b> Shows the strength of the current received signal.
<b>SETTINGS</b>	Default: <b>XX</b>
<b>AUTO ANSWER</b>	<b>1 — 30:</b> The unit answer incoming call automatically in the selected time. ; <b>OFF:</b> Cancels.
<b>RING MODE</b>	<p><b>SYSTEM:</b> The unit rings to notify you when a call/text message comes in. (Default ring tone is different according to the paired device.)</p> <ul style="list-style-type: none"> <li><b>CALL:</b> Selects your preferred ring tone (<b>TONE 1 — 5</b>) for incoming calls.</li> <li><b>MESSAGE:</b> Selects your preferred ring tone (<b>TONE 1 — 5</b>) for incoming text messages.</li> </ul> <p><b>PHONE:</b> The unit uses the connected phones' ring tone to notify you when a call/text message comes in. (The connected phone will ring if it does not support this feature.)</p>
<b>SMS NOTIFY*</b>	<b>ON:</b> The unit rings and "SMS RECEIVED" appears to notify you of an incoming text message. ; <b>OFF:</b> Cancels.

\* Functionality depends on the type of the phone used.

### Select a contact by name

- You can search through the contacts quickly according to the first letter (A to Z), number (0 to 9), or symbol.
- The second alphabet of the contact will be searched if the first alphabet does not exist.

- Press to enter Bluetooth mode.
- Turn the volume knob to select [PHONE BOOK], then press the knob.
- Turn the volume knob quickly to enter alphabet search mode.  
The first menu (ABCDEFGHIJK) appears. To go to the other menu (LMNOPQRSTUVWXYZ or WXYZ1\*), press / .
- Turn the volume knob or press / to select the desired first letter, then press the knob.
  - To search with numbers, select "1".
  - To search with symbols, select "X".

- Turn the volume knob to select a name, then press the knob.
- Turn the volume knob to select a phone number, then press the knob to call.

To return to the previous hierarchy, press / .

### Store a contact in memory

You can store up to 6 contacts.

- Press to enter Bluetooth mode.
- Turn the volume knob to select [CALL HISTORY], [PHONE BOOK], or [NUMBER DIAL], then press the knob.
- Turn the volume knob to select a contact or enter a phone number.  
If a contact is selected, press the volume knob to show the phone number.
- Press and hold one of the number buttons (1 to 6).  
"STORED" appears when the contact is stored.

To erase a contact from the preset memory, select [NUMBER DIAL] in step 2 and store a blank number.

### Make a call from memory

- Press to enter Bluetooth mode.
- Press one of the number buttons (1 to 6).
- Press the volume knob to call.  
"NO MEMORY" appears if there is no contacts stored.

### Delete a contact

Not applicable for mobile phone that supports PBAP.

- Press to enter Bluetooth mode.
- Turn the volume knob to select [CALL HISTORY] or [PHONE BOOK], then press the knob.

## BLUETOOTH®

- Turn the volume knob to select a contact. If a contact is selected, press the volume knob to show the phone number.
- Press and hold the volume knob to enter delete mode.
- Turn the volume knob to select [DELETE ONE] or [DELETE ALL], then press the knob.  
DELETE ONE: Selected name or phone number in step 3 is deleted.  
DELETE ALL: All names or phone numbers from the selected menu in step 2 is deleted.
- Turn the volume knob to select [YES] or [NO], then press the knob.

### Bluetooth mode settings

- Press the volume knob to enter [FUNCTION].
- Turn the volume knob to select [BT MODE], then press the knob.
- Turn the volume knob to make a selection (see the following table), then press the knob.
- Press and hold  $\mathcal{Q}$ / $\mathcal{S}$  to exit.

To return to the previous setting item or hierarchy, press  $\mathcal{Q}$ / $\mathcal{S}$ .

Default: **XX**

PHONE SELECT	Selects the phone or audio device to connect or disconnect.
AUDIO SELECT	"*" appears in front of the device name.
DEVICE DELETE	<ol style="list-style-type: none"><li>Turn the volume knob to select a device to delete, then press the knob.</li><li>Turn the volume knob to select [YES] or [NO], then press the knob.</li></ol>

DVC PRIORITY	Selects a device to be connected as priority device. "*" appears in front of the device name set as priority.
TRANSFER PB*	"DL PB *-*" appear and transfer the phonebook of the connected phone to this unit manually. * Selectable only when the connected phone supports OPP.
PIN CODE EDIT (0000)	Changes the PIN code (up to 6 digits). <ol style="list-style-type: none"><li>Turn the volume knob to select a number.</li><li>Press <math>\mathcal{L}</math>/<math>\mathcal{R}</math> to move the entry position. Repeat steps 1 and 2 until you finish entering the PIN code.</li><li>Press the volume knob to confirm.</li></ol>
RECONNECT	<b>ON</b> : The unit automatically reconnect when the Bluetooth device is within range.; <b>OFF</b> : Cancels.
AUTO PAIRING	<b>ON</b> : The unit automatically pair supported Bluetooth device (iPhone/iPod touch) when it is connected through USB input terminal. Depending on the iOS version of the connected iPhone/iPod touch, this function may not work.; <b>OFF</b> : Cancels.
BT HF/AUDIO	<b>FRONT</b> : Outputs audio from the front left and right speakers.; <b>ALL</b> : Outputs audio from all the speakers.
INITIALIZE	<b>YES</b> : Initializes all the Bluetooth settings (including stored pairing, phonebook, and etc.).; <b>NO</b> : Cancels.

### Bluetooth audio player

Operations and display indications may differ according to their availability on the connected device.

To	Do this
Playback	<ol style="list-style-type: none"><li>Press <math>\mathcal{P}</math> SRC to select BT AUDIO.</li><li>Operate the Bluetooth audio player to start playback.</li></ol>
Pause or resume playback	Press $\mathcal{6}$ $\mathcal{P}$ .
Select group or folder	Press $\mathcal{A}$ / $\mathcal{V}$ .
Reverse/forward skip	Press $\mathcal{L}$ / $\mathcal{R}$ .
Reverse/fast-forward	Press and hold $\mathcal{L}$ / $\mathcal{R}$ .
Repeat play	Press $\mathcal{4}$ $\mathcal{P}$ repeatedly to make a selection. ALL REPEAT, FILE REPEAT, REPEAT OFF
Random play	Press $\mathcal{3}$ $\mathcal{P}$ repeatedly to make a selection. FOLDER RANDOM, RANDOM OFF Press and hold $\mathcal{3}$ $\mathcal{P}$ to select "ALL RANDOM."

# AUDIO SETTINGS

While listening to any source...

- 1 Press the volume knob to enter [FUNCTION].
- 2 Turn the volume knob to select [AUDIO CONTROL], then press the knob.
- 3 Turn the volume knob to make a selection (see the following table), then press the knob.  
Repeat step 3 until the desired item is selected or activated.
- 4 Press and hold  $\mathcal{Q}$ / $\mathcal{S}$  to exit.

To return to the previous setting item or hierarchy, press  $\mathcal{Q}$ / $\mathcal{S}$ .

Default: **XX**

<b>SUB-W LEVEL</b>	-15 to +15 (0)	Adjusts the subwoofer output level.
<b>BASS LEVEL</b>	-8 to +8 (+6)	Adjusts the level to memorize for each source. (Before making an adjustment, select the source you want to adjust.)
<b>MID LEVEL</b>	-8 to +8 (+5)	
<b>TRE LEVEL</b>	-8 to +8 (0)	
<b>EQ PRO</b>		
<b>BASS ADJUST</b>	<b>BASS CTR FRQ</b>	60/ 80/ 100/ 200: Selects the center frequency.
	<b>BASS LEVEL</b>	-8 to +8 (+6): Adjusts the level.
	<b>BASS Q FACTOR</b>	1.00/ 1.25/ 1.50/ 2.00: Adjusts the quality factor.
	<b>BASS EXTEND</b>	ON: Turns on the extended bass. ; OFF: Cancels.
<b>MID ADJUST</b>	<b>MID CTR FRQ</b>	0.5/ 1.0/ 1.5/ 2.5K: Selects the center frequency.
	<b>MID LEVEL</b>	-8 to +8 (+5): Adjusts the level.
	<b>MID Q FACTOR</b>	0.75/ 1.00/ 1.25: Adjusts the quality factor.
<b>TRE ADJUST</b>	<b>TRE CTR FRQ</b>	10.0/ 12.5/ 15.0/ 17.5K: Selects the center frequency.
	<b>TRE LEVEL</b>	-8 to +8 (0): Adjusts the level.

<b>PRESET EQ</b>	<b>DRIVE EQ/ TOP40/ POWERFUL/ ROCK/ POPS/ EASY/ JAZZ/ NATURAL/ USER:</b> Selects a preset equalizer suitable to the music genre. (Select [USER] to use the customized bass, middle, and treble settings.) <b>[DRIVE EQ]</b> is a preset equalizer that reduces noise from the road.
<b>BASS BOOST</b>	<b>LV1/ LV2/ LV3:</b> Selects your preferred bass boost level. ; <b>OFF:</b> Cancels.
<b>LOUDNESS</b>	<b>LV1/ LV2:</b> Selects your preferred low and high frequencies boost to produce a well-balanced sound at a low volume level. ; <b>OFF:</b> Cancels.
<b>SUBWOOFER SET</b>	<b>ON:</b> Turns on the subwoofer output. ; <b>OFF:</b> Cancels.
<b>LPF SUBWOOFER</b>	<b>THROUGH:</b> All signals are sent to the subwoofer. ; <b>85HZ/ 120HZ/ 160HZ:</b> Audio signals with frequencies lower than 85 Hz/ 120 Hz/ 160 Hz are sent to the subwoofer.
<b>SUB-W PHASE</b>	<b>REVERSE (180°)/ NORMAL (0°):</b> Selects the phase of the subwoofer output to be in line with the speaker output for optimum performance. (Selectable only if a setting other than [THROUGH] is selected for [LPF SUBWOOFER].)
<b>FADER</b>	<b>R15 to F15 (0):</b> Adjusts the rear and front speaker output balance.
<b>BALANCE</b>	<b>L15 to R15 (0):</b> Adjusts the left and right speaker output balance.
<b>VOLUME OFFSET (Default: 0)</b>	-8 to +8 (for AUX) ; -8 to 0 (for other sources): Presets the volume adjustment level of each source. (Before adjustment, select the source you want to adjust.)
<b>SOUND RECNRSTR (Sound reconstruction)</b>	<b>ON:</b> Creates realistic sound by compensating the high-frequency components and restoring the rise-time of the waveform that are lost in audio data compression. ; <b>OFF:</b> Cancels.

- [SUB-W LEVEL]/ [SUBWOOFER SET]/ [LPF SUBWOOFER]/ [SUB-W PHASE] is selectable only if [SWITCH PREOUT] is set to [SUB-W]. (↔ 4)
- [SUB-W LEVEL]/ [LPF SUBWOOFER]/ [SUB-W PHASE] is selectable only if [SUBWOOFER SET] is set to [ON].

# DISPLAY SETTINGS

- 1 Press the volume knob to enter [FUNCTION].
- 2 Turn the volume knob to select [DISPLAY], then press the knob.
- 3 Turn the volume knob to make a selection (see the following table), then press the knob.

Repeat step 3 until the desired item is selected or activated.

- 4 Press and hold  $\mathcal{Q}$ / $\mathcal{S}$  to exit.

To return to the previous setting item or hierarchy, press  $\mathcal{Q}$ / $\mathcal{S}$ .

Default: **XX**

<b>DIMMER</b>	<b>ON:</b> Dims the display illumination. ; <b>OFF:</b> Illuminates according to the [BRIGHTNESS] settings.
<b>BRIGHTNESS</b>	<b>LVL 0</b> — <b>LVL 31:</b> Selects your preferred brightness level for display illumination.
<b>TEXT SCROLL</b>	<b>AUTO/ ONCE:</b> Selects whether to scroll the display information automatically, or scroll only once. ; <b>OFF:</b> Cancels.

# MORE INFORMATION

## General

- This unit can only play the following CDs:



- Detailed information and notes about the playable audio files are stated in an online manual on the following web site: [www.kenwood.com/cs/ce/audiofile/](http://www.kenwood.com/cs/ce/audiofile/)

## Playable files

- Playable audio file: MP3 (.mp3), WMA (.wma)
- Playable disc media: CD-R/CD-RW/CD-ROM
- Playable disc file format: ISO 9660 Level 1/2, Joliet, Long file name.
- Playable USB device file system: FAT12, FAT16, FAT32

Even when audio files comply with the standards listed above, playback may be impossible depending on the types or conditions of media or device.

## Unplayable discs

- Discs that are not round.
- Discs with coloring on the recording surface or discs that are dirty.
- Recordable/ReWritable discs that have not been finalized.
- 8 cm CD. Attempting to insert using an adapter may cause malfunction.

## About USB devices

- This unit can play MP3/WMA/WAV files stored on a USB mass storage class device.
- You cannot connect a USB device via a USB hub.
- Connecting a cable whose total length is longer than 5 m may result in abnormal playback.
- This unit cannot recognize a USB device whose rating is other than 5 V and exceeds 1 A.

## About KENWOOD Music Editor Light and KENWOOD Music Control

- This unit supports the PC application KENWOOD Music Editor Light and Android™ application KENWOOD Music Control.
- When you play audio files with song data added using the KENWOOD Music Editor Light or KENWOOD Music Control, you can search for audio files by Genres, Artists, Albums, Playlists, and Songs.
- KENWOOD Music Editor Light and KENWOOD Music Control are available on the following web site: [www.kenwood.com/cs/ce/](http://www.kenwood.com/cs/ce/)

## About iPod/iPhone

Made for

- iPod touch (1st, 2nd, 3rd, 4th, and 5th generation)
- iPod classic
- iPod nano (3rd, 4th, 5th, 6th, and 7th generation)
- iPhone, iPhone 3G, 3GS, 4, 4S, 5
- For the latest compatible list and software versions of iPhone/iPod, see: [www.kenwood.com/cs/ce/ipod](http://www.kenwood.com/cs/ce/ipod)
- You cannot operate iPod if “KENWOOD” or “✓” is displayed on iPod.

## About Bluetooth

- Depending on the Bluetooth version of the device, some Bluetooth devices may not be able to connect to this unit.
- This unit may not work with some Bluetooth devices.
- Signal conditions vary, depending on the surroundings.
- For more information about Bluetooth, visit the following website: [www.kenwood.com/cs/ce/](http://www.kenwood.com/cs/ce/)



# TROUBLESHOOTING

Symptom	Remedy
Sound cannot be heard.	<ul style="list-style-type: none"> <li>Adjust the volume to the optimum level.</li> <li>Check the cords and connections.</li> </ul>
"PROTECT" appears and no operations can be done.	Check to be sure the terminals of the speaker wires are insulated properly, then reset the unit. If this does not solve the problem, consult your nearest service center.
<ul style="list-style-type: none"> <li>Sound cannot be heard.</li> <li>The unit does not turn on.</li> <li>Information shown on the display is incorrect.</li> </ul>	Clean the connectors. (➔ 2)
The unit does not work at all.	Reset the unit. (➔ 3)
<ul style="list-style-type: none"> <li>Radio reception is poor.</li> <li>Static noise while listening to the radio.</li> </ul>	<ul style="list-style-type: none"> <li>Connect the antenna firmly.</li> <li>Pull the antenna out all the way.</li> </ul>
"NA FILE" appears.	Make sure the disc contains supported audio files. (➔ 14)
"NO DISC" appears.	Insert a playable disc into the loading slot.
"TOC ERROR" appears.	Make sure the disc is clean and inserted properly.
"PLEASE EJECT" appears.	Reset the unit. If this does not solve the problem, consult your nearest service center.
Disc cannot be ejected.	Press and hold  to forcibly eject the disc. Be careful not to drop the disc when it is ejected. If this does not solve the problem, reset the unit. (➔ 3)
"READ ERROR" appears.	Copy the files and folders onto the USB device again. If this does not solve the problem, reset the USB device or use another USB device.
"NO DEVICE" appears.	Connect a USB device, and change the source to USB again.

Symptom	Remedy	
"COPY PRO" appears.	A copy-protected file is played.	
"NA DEVICE" appears.	Connect a supported USB device, and check the connections.	
"NO MUSIC" appears.	Connect a USB device that contains playable audio files.	
"iPod ERROR" appears.	<ul style="list-style-type: none"> <li>Reconnect the iPod.</li> <li>Reset the iPod.</li> </ul>	
Noise is generated.	Skip to another track or change the disc.	
Tracks do not play back as you intended them to play.	Playback order is determined when files are recorded.	
"READING" keeps flashing.	Do not use too many hierarchical levels or folders.	
Elapsed playing time is not correct.	This is caused by how the tracks are recorded.	
Correct characters are not displayed (e.g. album name).	This unit can only display uppercase letters, numbers, and a limited number of symbols. Uppercase Cyrillic letters can also be displayed if [RUSSIAN SET] is set to [РУССКИЙ ВКЛ]. (➔ 5)	
Bluetooth®	No Bluetooth device is detected.	<ul style="list-style-type: none"> <li>Search from the Bluetooth device again.</li> <li>Reset the unit. (➔ 3)</li> </ul>
	Pairing cannot be made.	<ul style="list-style-type: none"> <li>Make sure you have entered the same PIN code to both the unit and Bluetooth device.</li> <li>Delete pairing information from both the unit and the Bluetooth device, then perform pairing again. (➔ 9)</li> </ul>
	"DEVICE FULL" appears.	The number of registered devices has reached its limit. Retry after deleting an unnecessary device. (➔ 12, DEVICE DELETE)
	Echo or noise occurs.	<ul style="list-style-type: none"> <li>Adjust the microphone unit's position. (➔ 8)</li> <li>Check the [ECHO CANCEL] setting. (➔ 10)</li> </ul>

## TROUBLESHOOTING

		Symptom	Remedy
Bluetooth®		Phone sound quality is poor.	<ul style="list-style-type: none"> <li>Reduce the distance between the unit and the Bluetooth device.</li> <li>Move the car to a place where you can get a better signal reception.</li> </ul>
		<ul style="list-style-type: none"> <li>Voice calling method is not successful.</li> <li>"N/A VOICE TAG" appears.</li> </ul>	<ul style="list-style-type: none"> <li>Use voice calling method in a more quiet environment.</li> <li>Reduce the distance from the microphone when you speak the name.</li> <li>Make sure the same voice as the registered voice tag is used.</li> </ul>
		"NOT SUPPORT" appears.	The connected phone does not support Voice Recognition feature.
		<ul style="list-style-type: none"> <li>"NO ENTRY" appears.</li> <li>"NO PAIR" appears.</li> </ul>	There is no registered device connected/found via Bluetooth.
		"ERROR" appears.	Try the operation again. If "ERROR" appears again, check if the device supports the function you have tried.
		"NO INFO" appears.	Bluetooth device cannot get the contact information.
		Sound is being interrupted or skipped during playback of a Bluetooth audio player.	<ul style="list-style-type: none"> <li>Reduce the distance between the unit and the Bluetooth audio player.</li> <li>Turn off, then turn on the unit and try to connect again.</li> <li>Other Bluetooth devices might be trying to connect to the unit.</li> </ul>
		The connected Bluetooth audio player cannot be controlled.	<ul style="list-style-type: none"> <li>Check whether the connected Bluetooth audio player supports Audio/Video Remote Control Profile (AVRCP). (Refer to the instructions of your audio player.)</li> <li>Disconnect and connect the Bluetooth player again.</li> </ul>
		<ul style="list-style-type: none"> <li>"HF ERROR XX" appears.</li> <li>"BT ERROR" appears.</li> </ul>	Reset the unit and try the operation again. If this does not solve the problem, consult your nearest service center.

## SPECIFICATIONS

Tuner	FM	Frequency Range	87.5 MHz — 108.0 MHz (50 kHz space)
		Usable Sensitivity (S/N = 26 dB)	0.71 $\mu$ V/75 $\Omega$
		Quieting Sensitivity (DIN S/N = 46 dB)	2.0 $\mu$ V/75 $\Omega$
		Frequency Response ( $\pm$ 3 dB)	30 Hz — 15 kHz
		Signal-to-Noise Ratio (MONO)	64 dB
		Stereo Separation (1 kHz)	40 dB
MW	Frequency Range	531 kHz — 1 611 kHz (9 kHz space)	
	Usable Sensitivity (S/N = 20 dB)	28.2 $\mu$ V	
LW	Frequency Range	153 kHz — 279 kHz (9 kHz space)	
	Usable Sensitivity (S/N = 20 dB)	50 $\mu$ V	
CD player	Laser Diode	GaAlAs	
	Digital Filter (D/A)	8 times over sampling	
	Spindle Speed	500 rpm — 200 rpm (CLV)	
	Wow & Flutter	Below measurable limit	
	Frequency Response ( $\pm$ 1 dB)	20 Hz — 20 kHz	
	Total Harmonic Distortion (1 kHz)	0.01 %	
	Signal-to-Noise Ratio (1 kHz)	105 dB	
	Dynamic Range	90 dB	
	Channel Separation	85 dB	
MP3 Decode	Compliant with MPEG-1/2 Audio Layer-3		
WMA Decode	Compliant with Windows Media Audio		

## SPECIFICATIONS

USB	USB Standard	USB 1.1, USB 2.0 (Full speed)		
	File System	FAT12/16/ 32		
	Maximum Supply Current	DC 5 V $\pm$ 1 A		
	MP3 Decode	Compliant with MPEG-1/2 Audio Layer-3		
	WMA Decode	Compliant with Windows Media Audio		
	WAV Decode	Linear-PCM		
Bluetooth	Version	Bluetooth Ver.2.1+EDR Certified		
	Frequency Range	2.402 GHz — 2.480 GHz		
	Output Power	+4 dBm (MAX), 0 dBm (AVE) Power Class 2		
	Maximum Communication Range	Line of sight approx. 10 m		
	Profile	HFP (Hands-Free Profile) SPP (Serial Port Profile) PBAP (Phonebook Access Profile) OPP (Object Push Profile) A2DP (Advanced Audio Distribution Profile) AVRCP (Audio/Video Remote Control Profile)		
	Audio	Maximum Output Power	50 W $\times$ 4	
Output Power (DIN 45324, +B = 14.4 V)		30 W $\times$ 4		
Speaker Impedance		4 $\Omega$ — 8 $\Omega$		
Tone Action		Bass	200 Hz $\pm$ 8 dB	
		Middle	2.5 kHz $\pm$ 8 dB	
		Treble	12.5 kHz $\pm$ 8 dB	
Preout Level/Load (CD)	2 500 mV/10 k $\Omega$			
Preout Impedance	$\leq$ 600 $\Omega$			

Auxiliary	Frequency Response ( $\pm$ 3 dB)	20 Hz — 20 kHz	
	Input Maximum Voltage	1 200 mV	
	Input Impedance	30 k $\Omega$	
General	Operating Voltage	14.4 V (10.5 V — 16 V allowable)	
	Maximum Current Consumption	10 A	
	Operational Temperature Range	0°C — +40°C	
	Installation Size (W $\times$ H $\times$ D)	182 mm $\times$ 53 mm $\times$ 159 mm	
	Weight	1.3 kg	

Subject to change without notice.

## ▲ Warning

- The unit can only be used with a 12 V DC power supply, negative ground.
- Disconnect the battery's negative terminal before wiring and mounting.
- Do not connect Battery wire (yellow) and Ignition wire (red) to the car chassis or Ground wire (black) to prevent a short circuit.
- Insulate unconnected wires with vinyl tape to prevent a short circuit.
- Be sure to ground this unit to the car's chassis again after installation.

## ▲ Caution

- For safety's sake, leave wiring and mounting to professionals. Consult the car audio dealer.
- Install this unit in the console of your vehicle. Do not touch the metal parts of this unit during and shortly after use of the unit. Metal parts such as the heat sink and enclosure become hot.
- Do not connect the  $\ominus$  wires of speakers to the car chassis or Ground wire (black), or connect them in parallel.
- Mount the unit at an angle of less than 30°.
- If your vehicle wiring harness does not have the ignition terminal, connect Ignition wire (red) to the terminal on the vehicle's fuse box which provides 12 V DC power supply and is turned on and off by the ignition key.
- After the unit is installed, check whether the brake lamps, blinkers, wipers, etc. on the car are working properly.
- If the fuse blows, first make sure the wires are not touching car's chassis, then replace the old fuse with one that has the same rating.

## Basic procedure

- 1 Remove the key from the ignition switch, then disconnect the  $\ominus$  terminal of the car battery.
- 2 Connect the wires properly.  
See Wiring connection. (→ 19)
- 3 Install the unit to your car.  
See Installing the unit (in-dash mounting).
- 4 Connect the  $\ominus$  terminal of the car battery.
- 5 Reset the unit. (→ 3)

## Installing the unit (in-dash mounting)

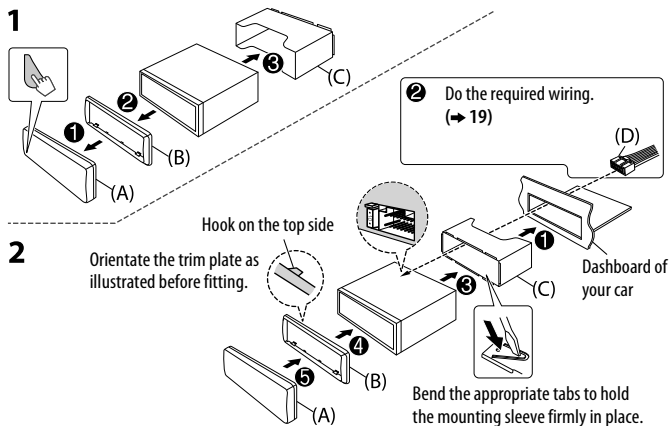

## How to remove the unit

- 1 Detach the faceplate.
- 2 Fit the catch pin on the extraction keys into the holes on both sides of the trim plate, then pull it out.
- 3 Insert the extraction keys deeply into the slots on each side, then follow the arrows as shown on the right.

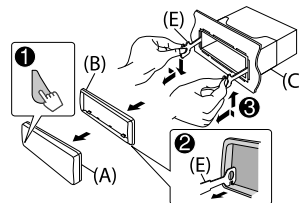

## Wiring connection

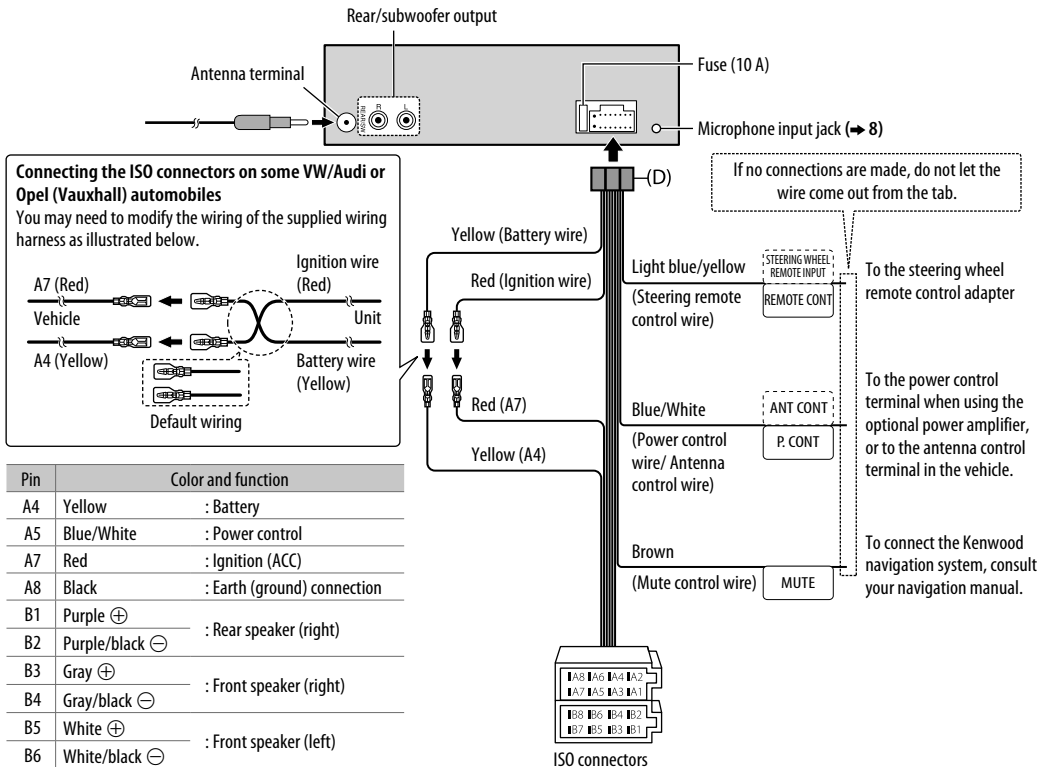

Pin	Color and function
A4	Yellow : Battery
A5	Blue/White : Power control
A7	Red : Ignition (ACC)
A8	Black : Earth (ground) connection
B1	Purple ⊕
B2	Purple/black ⊖ : Rear speaker (right)
B3	Gray ⊕
B4	Gray/black ⊖ : Front speaker (right)
B5	White ⊕
B6	White/black ⊖ : Front speaker (left)
B7	Green ⊕
B8	Green/black ⊖ : Rear speaker (left)

## Part list for installation

### (A) Faceplate

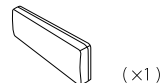

### (B) Trim plate

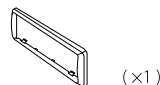

### (C) Mounting sleeve

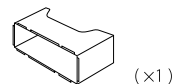

### (D) Wiring harness

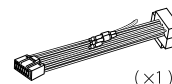

### (E) Extraction key

