

KENWOOD

Steering Wheel Remote Control Adaptor

CAW-LR7320

Landrover Discovery 04/01-09/04 (With stalk control)

Landrover Freelander 04/01-10/03 (With stalk control)

MG ZT/ZR/ZS 09/01 > (BMW connector)

Rover 75 06/99 > (Only with BMW loom)

Check for latest updates on:
www.kenwood.eu

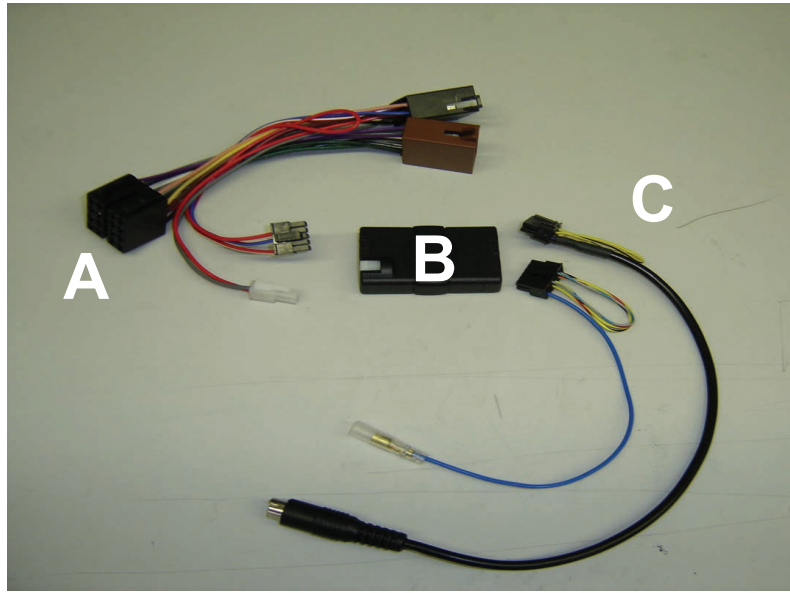

1

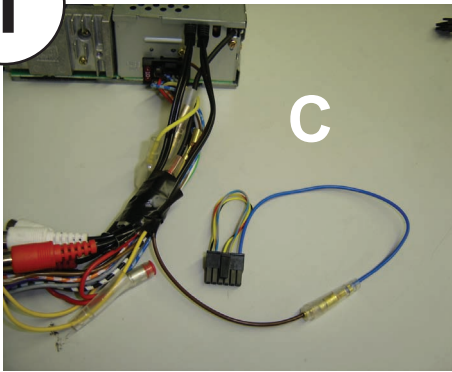

OR

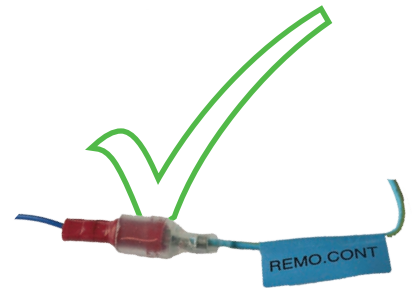
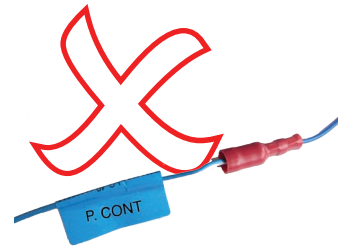
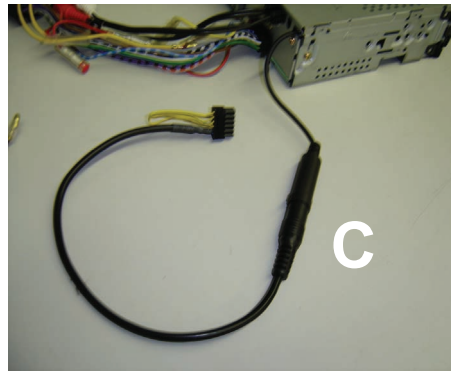

2

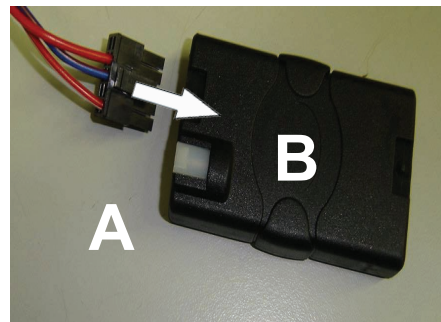
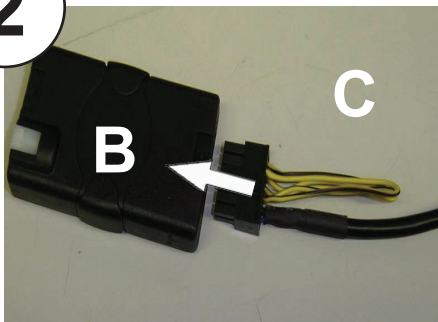

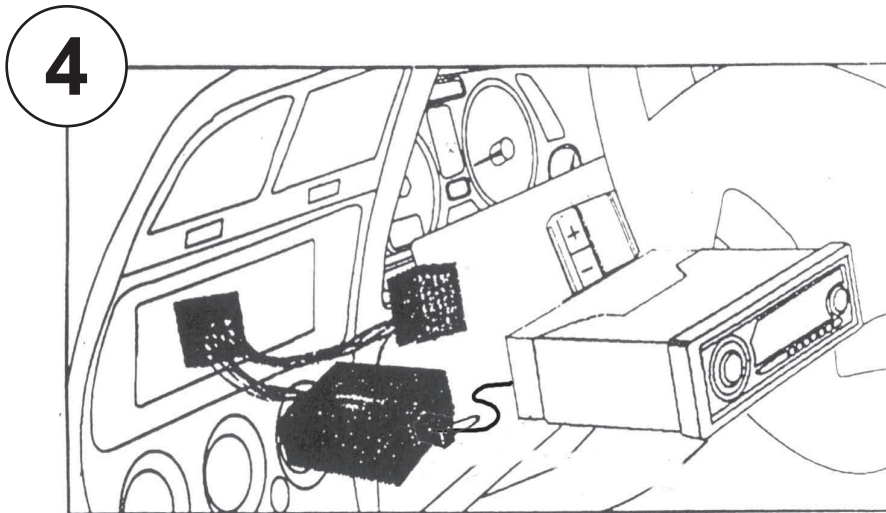
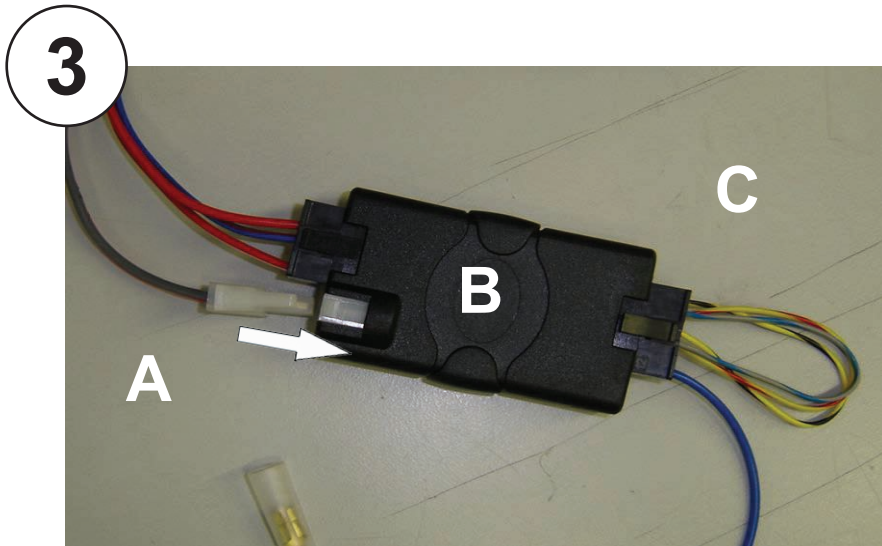

5

Vehicle Function	Click	Hold
Vol +	Vol +	-
Vol -	Vol -	-
▶ Mode	Source	-
▶	Seek +	Preset +
◀	Seek -	Preset -
Mute	Mute	-

*Functions Given are a general guide, exact functionality may vary with Kenwood Model/Vehicle