

KENWOOD

AUDIO VIDEO SURROUND RECEIVER

KRF-V6100D

KRF-V5100D

INSTRUCTION MANUAL

Kenwood Corporation

This instruction manual is for some models. Model availability and features (functions) may differ depending on the country and sales area.

About the supplied remote control

Compared to standard remote controls, the remote control supplied with this model has several operation modes. These modes enable the remote control to control other KENWOOD DVD players. In order to effectively use the remote control it is important to read the operating instructions and obtain a proper understanding of the remote control and how to switch its operation modes (etc.).

Using the remote control without completely understanding its design and how to switch the operation modes may result in incorrect operations.



RDS

Before applying power

Caution : Read this page carefully to ensure safe operation.

Units are designed for operation as follows.

Australia AC 240 V only
Europe and U.K. AC 230 V only

Information on Disposal of Old Electrical and Electronic Equipment (applicable for EU countries that have adopted separate waste collection systems)



Products with the symbol (crossed-out wheeled bin) cannot be disposed as household waste. Old electrical and electronic equipment should be recycled at a facility capable of handling these items and their waste byproducts.

Contact your local authority for details in locating a recycle facility nearest to you. Proper recycling and waste disposal will help conserve resources whilst preventing detrimental effects on our health and the environment.

Safety precautions

WARNING :

TO PREVENT FIRE OR ELECTRIC SHOCK,
DO NOT EXPOSE THIS APPLIANCE TO
RAIN OR MOISTURE.



CAUTION
RISK OF ELECTRIC SHOCK
DO NOT OPEN



CAUTION: TO REDUCE THE RISK OF ELECTRIC SHOCK, DO NOT REMOVE COVER (OR BACK). NO USER-SERVICEABLE PARTS INSIDE. REFER SERVICING TO QUALIFIED SERVICE PERSONNEL.



THE LIGHTNING FLASH WITH ARROWHEAD SYMBOL, WITHIN AN EQUILATERAL TRIANGLE, IS INTENDED TO ALERT THE USER TO THE PRESENCE OF UNINSULATED "DANGEROUS VOLTAGE" WITHIN THE PRODUCT'S ENCLOSURE THAT MAY BE OF SUFFICIENT MAGNITUDE TO CONSTITUTE A RISK OF ELECTRIC SHOCK TO PERSONS.



THE EXCLAMATION POINT WITHIN AN EQUILATERAL TRIANGLE IS INTENDED TO ALERT THE USER TO THE PRESENCE OF IMPORTANT OPERATING AND MAINTENANCE (SERVICING) INSTRUCTIONS IN THE LITERATURE ACCOMPANYING THE APPLIANCE.

Unpacking

Unpack the unit carefully and make sure that all the accessories are present.

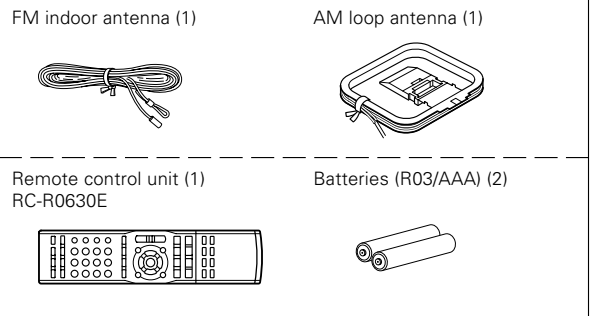

If any accessories are missing, or if the unit is damaged or fails to operate, notify your dealer immediately. If the unit was shipped to you directly, notify your shipper immediately. Kenwood recommends that you retain the original carton and packing materials in case you need to move or ship the unit in the future.

Keep this manual handy for future reference.

How to use this manual

This manual is divided into four sections, Preparations, Operations, Remote Control, and Additional Information.

Preparations

Shows you how to connect your audio and video components to this model and prepare the surround processor. Since this model works with all of your audio and video components, we will guide you in setting up your system to be as easy as possible.

Operations

Shows you how to operate the various functions available on this model.

Remote Control

Shows you how to operate other components using the remote control, as well as a detailed explanation of all remote control operations. Once you have setup the remote control, you'll be able to operate both this model and your KENWOOD DVD player using the remote control supplied with this model.

Additional Information

Shows you additional information such as "In case of difficulty" (troubleshooting) and "Specifications".

Memory back up function

Please note that the following items will be deleted from the unit's memory if the power cord is disconnected from the AC outlet for approximately 1 day.

- Power mode
- Input selector settings
- Picture output
- Speaker ON/OFF
- Volume level
- BASS, TREBLE, INPUT level
- TONE ON/OFF
- LOUDNESS ON/OFF
- ACTIVE EQ mode
- Dimmer level
- MD/TAPE settings
- Input mode setting
- Speaker settings
- Sound mode settings
- Distance setting
- Listen mode setting
- Broadcast band
- Frequency setting
- Preset stations
- Tuning mode

IMPORTANT SAFETY INSTRUCTIONS

 **Caution:** Read this page carefully to ensure safe operation.

Read Instructions – All the safety and operating instructions should be read before the product is operated.

Retain Instructions – The safety and operating instructions should be retained for future reference.

Heed Warnings – All warnings on the product and in the operating instructions should be adhered to.

Follow Instructions – All operating and use instructions should be followed.

1. Cleaning – Unplug this product from the wall outlet before cleaning. Do not use liquid cleaners or aerosol cleaners. Use a damp cloth for cleaning.

2. Attachments – Do not use attachments not recommended by the product manufacturer as they may cause hazards.

3. Water and Moisture – This product shall not be exposed to dripping and splashing – for example, near a bath tub, wash bowl, kitchen sink, or laundry tub; in a wet basement; or near a swimming pool; and the like. Do not place an object containing liquid, such as a flower vase, on the appliance.

4. Accessories – Do not place this product on an unstable cart, stand, tripod, bracket, or table. The product may fall, causing serious injury to a child or adult, and serious damage to the product. Use only with a cart, stand, tripod, bracket, or table recommended by the manufacturer. Any mounting of the product should follow the manufacturer's instructions, and should use a mounting accessory recommended by the manufacturer.

A product and cart combination should be moved with care. Quick stops, excessive force, and uneven surfaces may cause the product and cart combination to overturn.



5. Ventilation – Slots and openings in the cabinet are provided for ventilation and to ensure reliable operation of the product and to protect it from overheating, and these openings must not be blocked or covered. The openings should never be blocked by placing the product on a bed, sofa, rug, or other similar surface. This product should not be placed in a built-in installation such as a bookcase or rack unless proper ventilation is provided or the manufacturer's instructions have been adhered to.

6. Power Sources – This product should be operated only from the type of power source indicated on the product. If you are not sure of the type of power supply to your home, consult your product dealer or local power company.

7. CAUTION - Polarization – This product may be equipped with a polarized alternating-current line plug (a plug having one blade wider than the other). This plug will fit into the power outlet only one way. This is a safety feature. If you are unable to insert the plug fully into the outlet, try reversing the plug. If the plug should still fail to fit, contact your electrician to replace your obsolete outlet. Do not defeat the safety purpose of the polarized plug.

8. Power Cord Protection – Power-supply cords should be routed so that they are not likely to be walked on or pinched by items placed upon or against them, paying particular attention to cords at plugs, convenience receptacles, and the point where they exit from the product.

9. Lightning – For added protection for this product during a lightning storm, or when it is left unattended and unused for long periods of time, unplug it from the wall outlet and disconnect the antenna or cable system. This will prevent damage to the product due to lightning and power-line surges.

10. Overloading – Do not overload wall outlets, extension cords, or integral convenience receptacles as this can result in a risk of fire or electric shock.

11. Object and Liquid Entry – Never push objects of any kind into this product through openings as they may touch dangerous voltage points or short-out parts that could result in a fire or electric shock. Never spill liquid of any kind on the product.

12. Servicing – Do not attempt to service this product yourself as opening or removing covers may expose you to dangerous voltage or other hazards. Refer all servicing to qualified service personnel.

13. Damage Requiring Service – Unplug this product from the wall outlet and refer servicing to qualified service personnel under the following conditions:

- When the power-supply cord or plug is damaged,
- If liquid has been spilled, or objects have fallen into the product,
- If the product has been exposed to rain or water,
- If the product does not operate normally by following the operating instructions.
- If the product has been dropped or damaged in any way, and
- When the product exhibits a distinct change in performance – this indicates a need for service.
- If an abnormal smell or smoke is detected.

14. Replacement Parts – When replacement parts are required, be sure the service technician has used replacement parts specified by the manufacturer or have the same characteristics as the original part. Unauthorized substitutions may result in fire, electric shock, or other hazards.

15. Safety Check – Upon completion of any service or repairs to this product, ask the service technician to perform safety checks to determine that the product is in proper operating condition.

16. Wall or Ceiling Mounting – This product should be mounted to a wall or ceiling only as recommended by the manufacturer.

17. Heat – This product should be situated away from heat sources such as radiators, heat registers, stoves, or other products that produce heat. Do not place a flaming object, such as a candle or lantern, or near the product.

18. Power Lines – An outside antenna system should not be located in the vicinity of overhead power lines or other electric light or power circuits, or where it can fall into such power lines or circuits. When installing an outside antenna system, extreme care should be taken to keep from touching such power lines or circuits as contact with them might be fatal.

19. Outdoor Antenna Grounding – If an outside antenna or cable system is connected to the product, be sure the antenna or cable system is grounded so as to provide some protection against voltage surges and built-up static charges. Article 810 of the National Electrical Code, ANSI/NFPA 70, provides information with regard to proper grounding of the mast and supporting structure, grounding of the lead-in wire to an antenna discharge unit, size of grounding conductors, location of antenna-discharge unit, connection to grounding electrodes, and requirements for the grounding electrode.

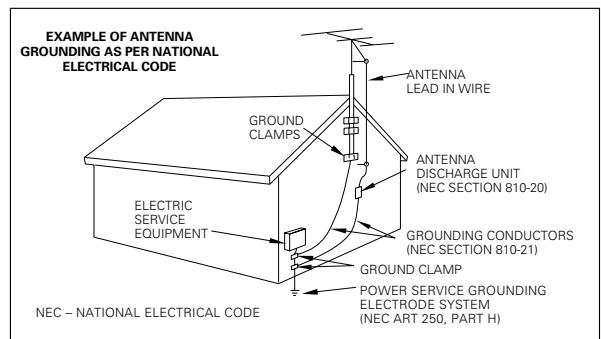



Notes

- Item 7 is not required except for grounded or polarized equipment.
- Item 19 complies with UL in the U.S.A.

Contents

Caution : Read the pages marked  carefully to ensure safe operation.

| | | |
|--|--|----------|
|  | Before applying power | 2 |
|  | Safety precautions | 2 |
| | Unpacking | 2 |
| | How to use this manual | 2 |
|  | IMPORTANT SAFETY INSTRUCTIONS | 3 |
| | Preparing the remote control | 4 |
| | Special features | 5 |
| | Names and functions of parts | 6 |
| | Main unit | 6 |
| | Remote control unit | 7 |

Preparations

| | |
|---|-----------|
| Setting up the system | 8 |
| Connecting a DVD player (6-channel input) | 9 |
| Connecting audio components | 10 |
| Connecting video components | 11 |
| Connecting video components (COMPONENT VIDEO) (KRF-V6100D only) | 12 |
| Digital connections | 13 |
| Connecting the speakers | 14 |
| Connecting the terminals | 15 |
| Connecting the antennas | 15 |
| Preparing for surround sound | 16 |
| Speaker settings | 16 |

Operations

| | |
|---|-----------|
| Normal playback | 19 |
| Preparing for playback | 19 |
| Listening to a source component | 19 |
| Adjusting the sound | 20 |
| Recording | 21 |
| Recording audio (analog sources) | 21 |
| Recording video | 21 |
| Recording audio (digital sources) | 21 |
| Listening to radio broadcasts | 22 |
| Tuning (non-RDS) radio stations | 22 |
| Using RDS (Radio Data System) | 22 |
| Presetting radio stations manually | 23 |
| Receiving preset stations | 23 |
| Receiving preset stations in order (P.CALL) | 24 |
| Using the RDS DISP. (Display) key | 24 |
| Presetting RDS stations (RDS AUTO MEMORY) | 25 |
| Tuning by Program Type (PTY search) | 25 |
| Ambience effects | 26 |
| Surround modes | 26 |
| Surround play | 28 |
| DVD 6-channel playback | 29 |
| Convenient functions | 30 |

Remote Control

| | |
|--|-----------|
| Basic remote control operations for KENWOOD DVD players | 32 |
| DVD player operation keys | 32 |

Additional Information

| | |
|---|-----------|
| In case of difficulty | 33 |
|  Specifications (For Europe) | 35 |
|  Specifications (For Australia) | 36 |

Preparing the remote control

Loading the batteries

❶ Remove the cover.

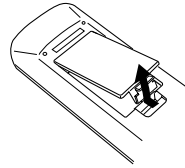

❷ Insert the batteries.

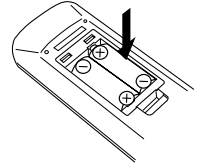

❸ Close the cover.

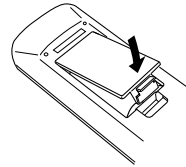

- Insert two AAA-size (R03) batteries as indicated by the polarity markings.

Operation

When the **STANDBY** indicator is lit, the power turns ON when you press the **RECEIVER** key on the remote control unit. When the power comes ON, press the key you want to operate.

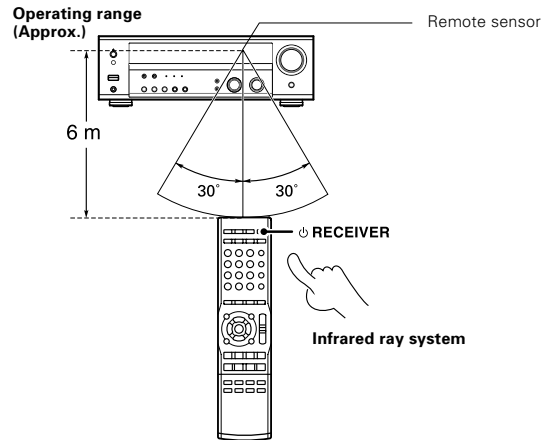

- When pressing more than one remote control key successively, press the keys securely by leaving an interval of 1 second or more between keys.

Notes

1. The supplied batteries may have shorter lives than ordinary batteries due to use during operation checks.
2. When the remote-controllable distance gets shorter than before, replace both batteries with new ones.
3. Placing the remote sensor in direct sunlight, or in direct light from a high frequency fluorescent lamp may cause a malfunction. In such a case, change the location of the system installation to prevent malfunction.

Special features

True home theater sound

This model incorporates a wide variety of surround modes to bring you maximum enjoyment from your video software. Select a surround mode according to your equipment or the software you are going to play and enjoy!
— [26]

Dolby Digital and Dolby Digital EX

The Dolby Digital mode lets you enjoy full digital surround from software processed in the Dolby Digital format. Dolby Digital provides up to 5.1 channels of independent digital audio for better sound quality and more powerful presence than conventional Dolby Surround. As for Dolby Digital EX, it creates six full-bandwidth output channels from the 5.1 channel sources. This is done using a matrix decoder that derives three surround channels from the two in the original recording. For best result, Dolby Digital EX should be used with movie soundtracks recorded with Dolby Digital Surround EX.

Dolby Pro Logic IIx and Dolby Pro Logic II

Dolby Pro Logic II, whilst totally compatible with its predecessor Pro Logic, provides greater advantages in surround sound. It allows user to enjoy the conventional stereo or Dolby Surround with a convincing "5.1 like" presentation. Pro Logic II offers special features for controlling the overall spatial, dimensionality and frontal sound field imaging. Pro Logic II produces an impressive surround sound from video software marked **DOLBY SURROUND** and three-dimensional space from music CD. When listening to music, you will be able to enjoy the experience of sheer STEREO surround sound.

Dolby Pro Logic IIx enhanced Dolby Pro Logic II's features. It creates 6.1 channel and 7.1 channel surround sound from stereo or 5.1 channel signals. This feature provides you an astonishing ambience effect which makes you feel you are surrounded by natural sound. Especially 7.1 channel surround sound can produce real back sound from Surround Back speakers.

DTS and DTS-ES

DTS (Digital Theater System) is a 5.1 channel digital audio format that provides five full-spectrum channels and one low-frequency (subwoofer) channel for unprecedented clarity, optimum channel separation and a (wide) dynamic range.

DTS-ES (Extended Surround) presents 6.1 channels surround system with additional Surround back channel which evolved from the conventional 5.1 channels surround system. DTS-ES format that was recorded in DVD, CD or LD comprises of two modes. DTS-ES Discrete 6.1 produces the discrete surround back which is completely independent and DTS-ES Matrix 6.1 produces the surround back which synthesized within the left and right surround channels using matrix technology. DTS-ES has perfect compatibility with the conventional 5.1 channels surround system. 6.1 channels surround with an additional surround back presents a more natural presence and surround effects by increasing the impression of the sound image from back.

Important:

When a DTS disc is played on a CD, LD or DVD player, noise may be output from the analog output. It is recommended that you connect the digital output of the player to the digital input of this unit.

Neo:6

Neo:6 is a new technology which was developed by DTS. It can produce high grade 6 channels surround with an astonishing fidelity from 2 channels content. Neo:6 has 2 modes, "CINEMA" mode is for movie playback and "MUSIC" mode is for music playback.

DSP surround modes

The DSP (Digital Signal Processor) used for this model incorporates a variety of high quality adjustable sound fields, like "ARENA", "JAZZ CLUB", "THEATER", "STADIUM" and "DISCO". It is compatible with almost any kind of program source.

DVD 6-channel input

If you own a DVD player equipped with 6-channel output, this model allows you to obtain the full surround sound impact of DVD source material featuring multi-channel encoding. Since the source signals are digital and each channel is input independently, the resulting ambience is far superior to what can be achieved with conventional surround sound systems.

ACTIVE EQ

ACTIVE EQ mode will produce a more dynamic sound quality in any condition. You can enjoy a more impressive sound effect when ACTIVE EQ is turned on.

IR (InfraRed) remote control

In addition to the basic receiver operations, this IR remote control supplied can also control KENWOOD DVD players directly without using the DVD Special features.

RDS (Radio Data System) tuner

This model is equipped with an RDS tuner that provides several convenient tuning functions: RDS Auto Memory, to automatically preset up to 40 RDS stations broadcasting different programs; station name display, to show you the name of the current broadcast station; and PTY search to let you tune stations by program type.

PTY (Program Type) search

Tune the stations by specifying the type of program you want to hear.

Names and functions of parts

Main unit

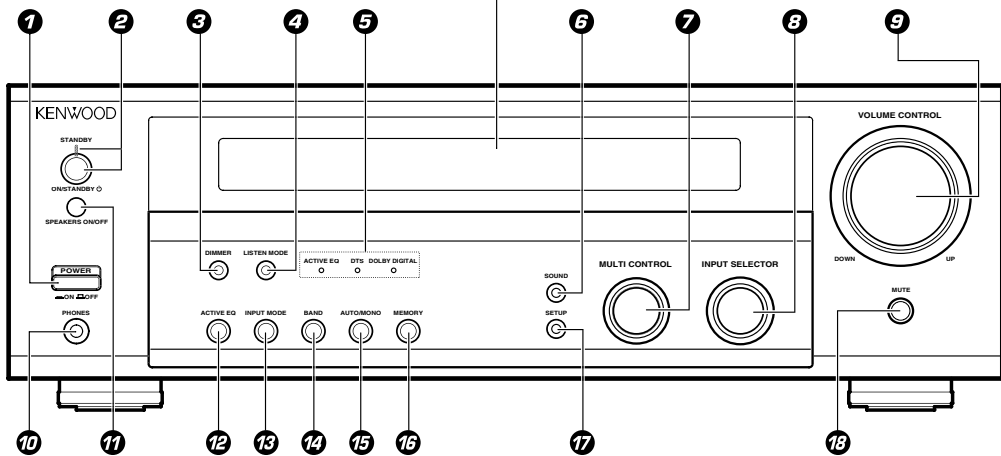
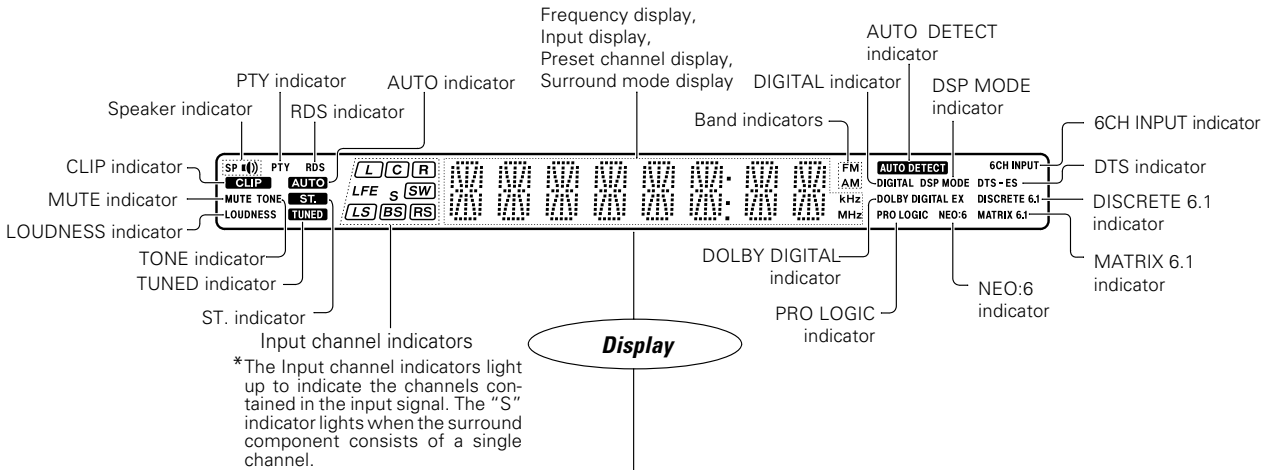

- | | | |
|--|--|---|
| 1 POWER ON/OFF key Use to turn the main power ON/OFF. - [16] | 6 SOUND key Use to adjust the sound quality and the ambience effects. - [30] | 15 AUTO/MONO key Use to change "TAPE" indication to "MD". - [19] |
| 2 ON/STANDBY key Use to switch the power ON/STANDBY when the POWER is turned ON. STANDBY indicator | 7 MULTI CONTROL knob Use to control a variety of settings. - [16] | 16 MEMORY key Use to store radio stations in the preset memory. - [22] |
| 3 DIMMER key Use to select the REC MODE. - [21] Use to adjust the brightness of the display. - [31] | 8 INPUT SELECTOR knob Use to select the input sources. - [19] | 17 SETUP key Use to select the speakers' settings etc. - [16] |
| 4 LISTEN MODE key Use to select the listening mode. - [28] | 9 VOLUME CONTROL knob 10 PHONES jack Use for headphone listening. - [19] | 18 MUTE key Use to temporarily mute the sound. - [20] |
| 5 Surround LED (light-emitting diode) indicators ACTIVE EQ mode LED indicator - [20] Lights when this model is in the ACTIVE EQ mode. DTS mode LED indicator - [28] Lights when this model is in the DTS mode. DOLBY DIGITAL mode LED indicator - [28] Lights when this model is in the Dolby Digital mode. | 11 SPEAKERS ON/OFF key Use to turn the speakers ON/OFF. - [19] | |
| | 12 ACTIVE EQ key Use to select ACTIVE EQ setting. - [20] | |
| | 13 INPUT MODE key Use to switch between full auto, digital and analog inputs. - [8] | |
| | 14 BAND key Use to select the broadcast band. - [22] | |

Standby mode

While the standby indicator is lit, a small amount of power is supplied to the system to back up the memory. This is called standby mode. Under the condition, the system can be turned ON by the remote control unit.

Remote control unit

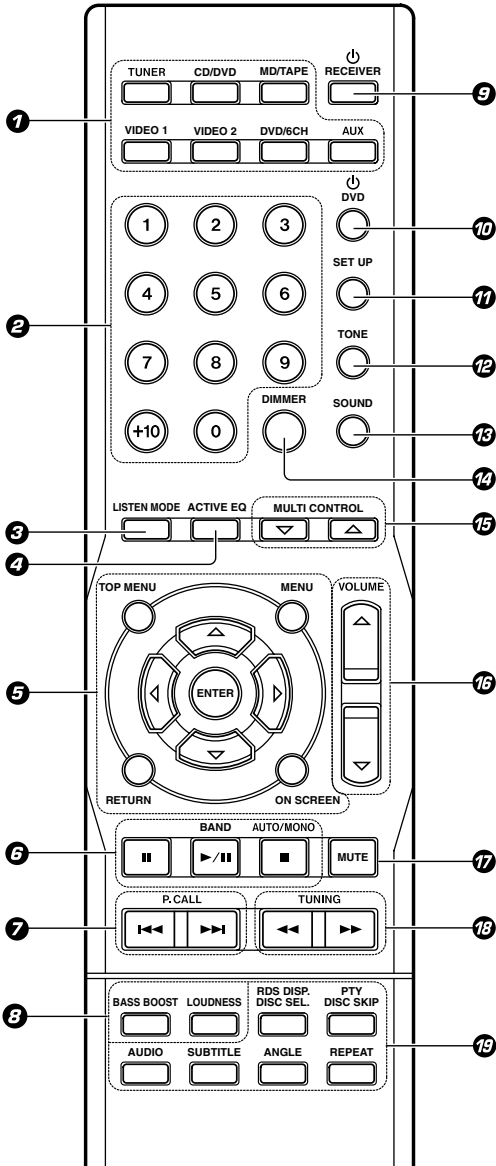

- 1 Input Selector keys (TUNER, CD/DVD, MD/TAPE, VIDEO 1, VIDEO 2, DVD/6CH, AUX)** - [19]
Use to select the input sources.
- 2 Numeric keys**
Use to operate the DVD player.
Use to call up preset stations.
- 3 LISTEN MODE key**
Use to select the listening mode.
- 4 ACTIVE EQ key** - [20]
Use to select ACTIVE EQ setting.
- 5 $\Delta/\nabla/\leftarrow/\rightarrow$ keys**
ENTER key
TOP MENU key
MENU key
RETURN key
ON SCREEN key
Use to operate the DVD player. - [32]
- 6 \parallel key** - [32]
Use to operate the DVD player.
BAND key - [22]
Use to select the broadcast band.
 $\blacktriangleright/\parallel$ key - [32]
Use to operate the DVD player.
AUTO/MONO key - [22]
Use to select the auto tuning mode.
 \blacksquare key - [32]
Use to operate the DVD player.
- 7 P.CALL: $\leftarrow/\blacktriangleright$ keys**
Use to call preset channel. - [24]
Use to operate the DVD player. - [32]
- 8 BASS BOOST key** - [20]
Use to select the maximum adjustment setting for the low frequency range.
LOUDNESS key - [20]
Use to switch the status of LOUDNESS.
- 9 \updownarrow RECEIVER key** - [16]
Use to turn this model on and off.
- 10 \updownarrow DVD key** - [32]
Use to turn on the DVD player on and off.
- 11 SETUP key**
Use to select the speakers' settings etc. - [16]
Use to operate the DVD player. - [32]
- 12 TONE key** - [20]
Use to switch the status of TONE control.
- 13 SOUND key** - [30]
Use to adjust the sound quality and ambience effects.
- 14 DIMMER key**
Use to adjust the brightness of the display. - [31]
Use to operate the DVD player. - [32]
- 15 MULTI CONTROL Δ/∇ keys** - [16]
Use to control a variety of settings.
- 16 VOLUME Δ/∇ keys** - [19]
Use to adjust volume setting.
- 17 MUTE key** - [20]
Use to temporarily mute the sound.
- 18 TUNING $\leftarrow/\blacktriangleright$ keys**
Use to select the radio station. - [22]
Use to operate the DVD player. - [32]
- 19 RDS DISP. key** - [24]
Use for RDS function.
PTY key - [25]
Use for PTY search.
DISC SEL. key
DISC SKIP key
AUDIO key
SUBTITLE key
ANGLE key
REPEAT key - [32]
Use to operate the DVD player.

• Some keys can be used for operating KENWOOD DVD players by pressing the CD/DVD or DVD/6CH key beforehand. - [32]

Setting up the system

Make connections as shown in the following pages. When connecting the related system components, be sure to refer to the instruction manuals supplied with the components you are connecting. Do not connect the power cord to a wall outlet until all connections are completed.

Notes

1. Be sure to insert all connection cords securely. If their connections are imperfect, the sound may not be produced or there will be noise interference.
2. Be sure to remove the power cord from the AC outlet before plugging or unplugging any connection cords. Plugging/unplugging connection cords without disconnecting the power cord can cause malfunctions and may damage the unit.
3. Do not connect power cords from components whose power consumption is larger than what is indicated on the AC outlet at the rear of this unit.

Analog connections

Audio connections are made using RCA pin cords. These cables transfer stereo audio signal in an "analog" form. This means the audio signal corresponds to the actual audio of two channels. These cables usually have 2 plugs at each end, red for the right channel and white for the left channel. These cables are usually packed together with the source unit, or are available at your local electronics retailer.

Microcomputer malfunction

If operation is not possible or an erroneous display appears, even though all connections have been made properly, reset the microcomputer by referring to "In case of difficulty". - 33

CAUTION

Install the equipment so that the power outlet is easily accessible and, in case of emergency, immediately unplug the power cord from the power outlet.

The power in this equipment will not be completely cut off from the AC wall outlet when the main switch is turned OFF.

Input mode settings

"CD/DVD", "VIDEO2" and "DVD/6CH" inputs each include jacks for digital audio input and analog audio input.

After completing connections and turning on this model, follow the steps below.

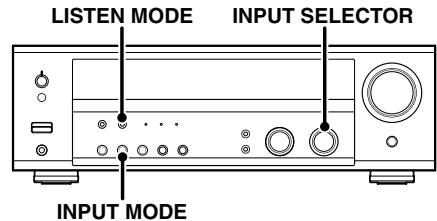

1 Use the INPUT SELECTOR knob to select "CD/DVD", "VIDEO2", "DVD/6CH".

2 Press the INPUT MODE key.

Each press switches the setting as follows:

In DTS play mode

- 1 F-AUTO (digital input, analog input)
- 2 D-MANUAL (digital input)

In CD/DVD, VIDEO2, DVD/6CH play mode

- 1 F-AUTO (digital input, analog input)
- 2 D-MANUAL (digital input)
- 3 6CH INPT (DVD/6CH input) *
- 4 ANALOG (analog input)

* "6CH INPT" setting can be switched only when the input selector is set to "DVD/6CH".

Digital input:

Select this setting to play digital signals from a DVD, CD, or LD player.

Analog input:

Select this setting to play analog signals from a cassette deck, VCR, or record player.

Auto detect:

In "F-AUTO" (full auto) mode (AUTO DETECT and DIGITAL indicators light up), this model detects the digital or analog input signals automatically. Priority is given to digital signal during input mode selection. This model will select the input mode and listening mode automatically during playback to match the type of input signal (Dolby Digital, PCM, DTS) and the speaker setting. The initial factory setting is full auto.

To keep this model set to the currently selected listening mode, use the INPUT MODE key to select "D-MANUAL" (digital manual). However, even when this setting is selected, there may be cases in which the listening mode is selected automatically to match a Dolby Digital source signal depending on the combination of listening mode and source digital.

In D-MANUAL mode, if the audio reproduction stops in the middle due to change in the input signals etc, press the LISTEN MODE key. If the INPUT MODE key is pressed quickly, sound may not be produced. Press the INPUT MODE key again.

Connecting a DVD player (6-channel input)

If you have connected a DVD player to this model with digital connection, be sure to read the "Input mode settings" section carefully.

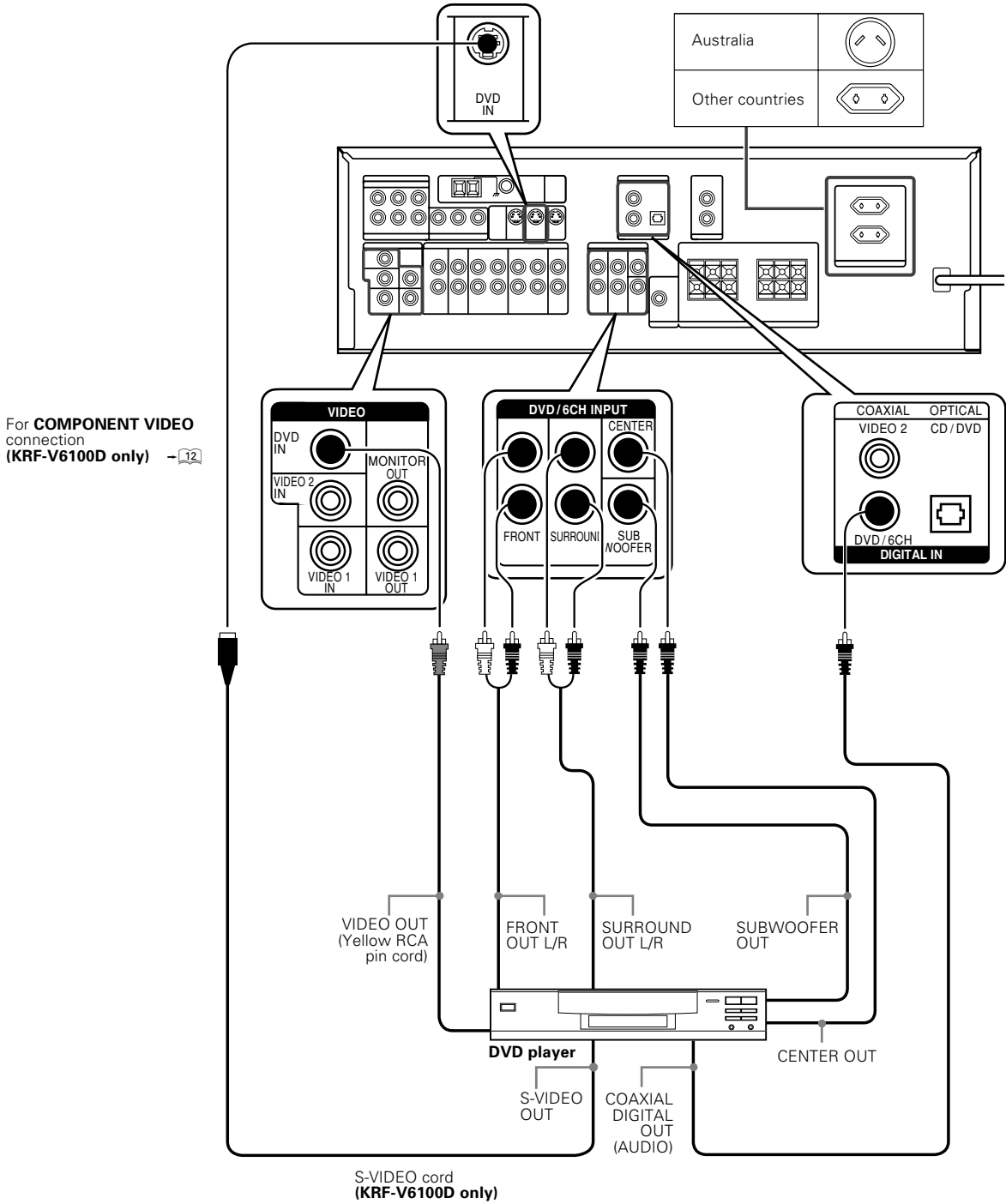

Connecting audio components

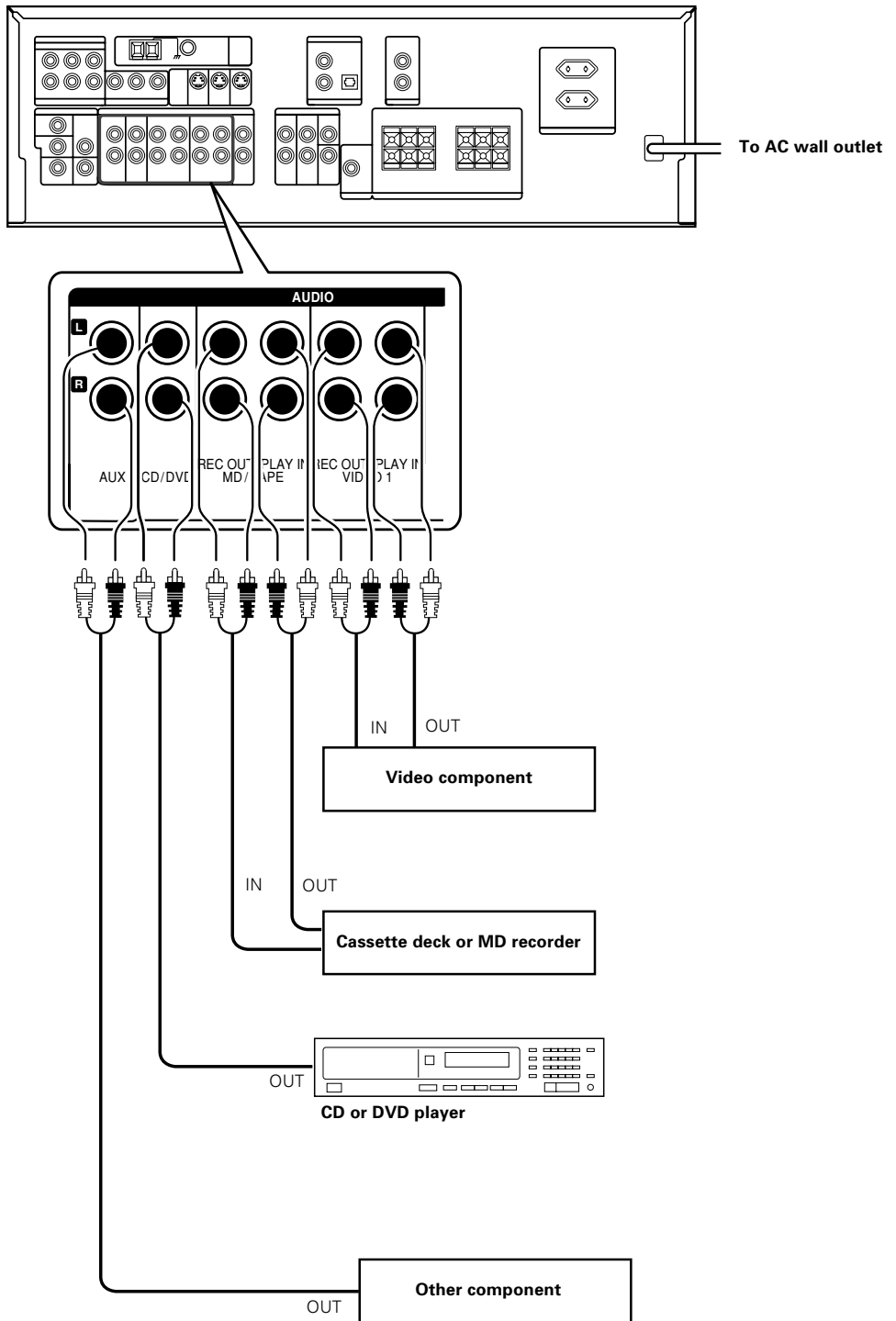

CAUTION

Be sure to adhere to the following, or proper ventilation will be blocked causing damage or fire hazard.

- Do not place any objects impairing heat radiation onto the top of the unit.
- Leave some space around the unit (from the largest outside dimension including projection) equal to or greater than, shown below.

Top panel : 50 cm

Side panel : 10 cm

Back panel : 10 cm

Connecting video components

About the S-VIDEO jacks

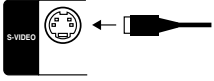

Use the S-VIDEO jacks to make connections to video components with S-VIDEO IN/OUT jacks.

- If you use the S-VIDEO jacks to connect your video playback components, be sure to use the S-VIDEO jacks when connecting your monitor and video recording components.

* DVD IN input jack is used for either CD/DVD input or DVD/6CH input.

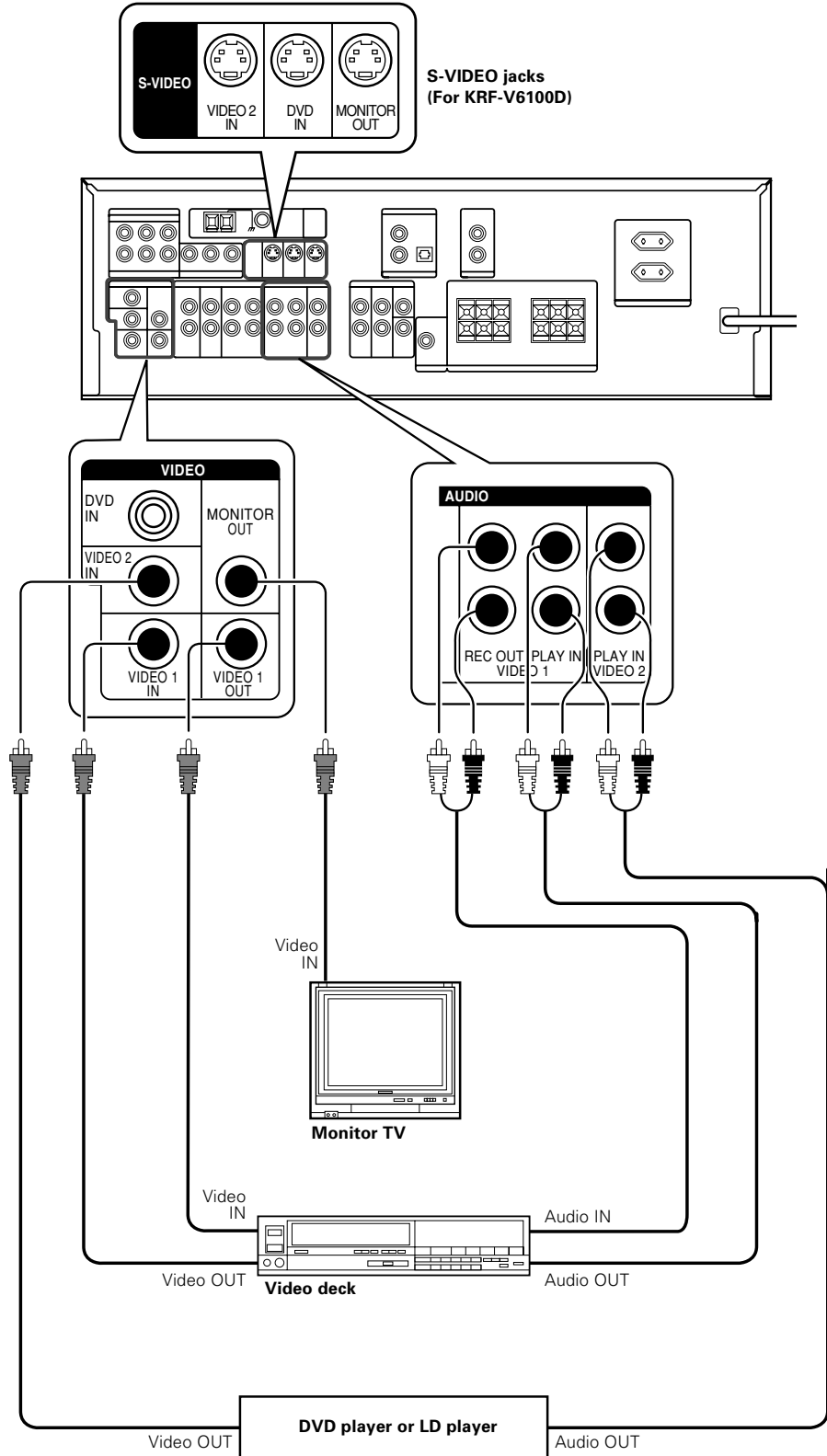

A video component with digital audio outputs should be connected to the VIDEO 2 jacks.

Connecting video components (COMPONENT VIDEO) (KRF-V6100D only)

If you have connected the receiver to a video component with COMPONENT jacks, you can get a better picture quality than by connecting to the S-VIDEO jacks.

* DVD IN input jack is used for either CD/DVD input or DVD/6CH input.

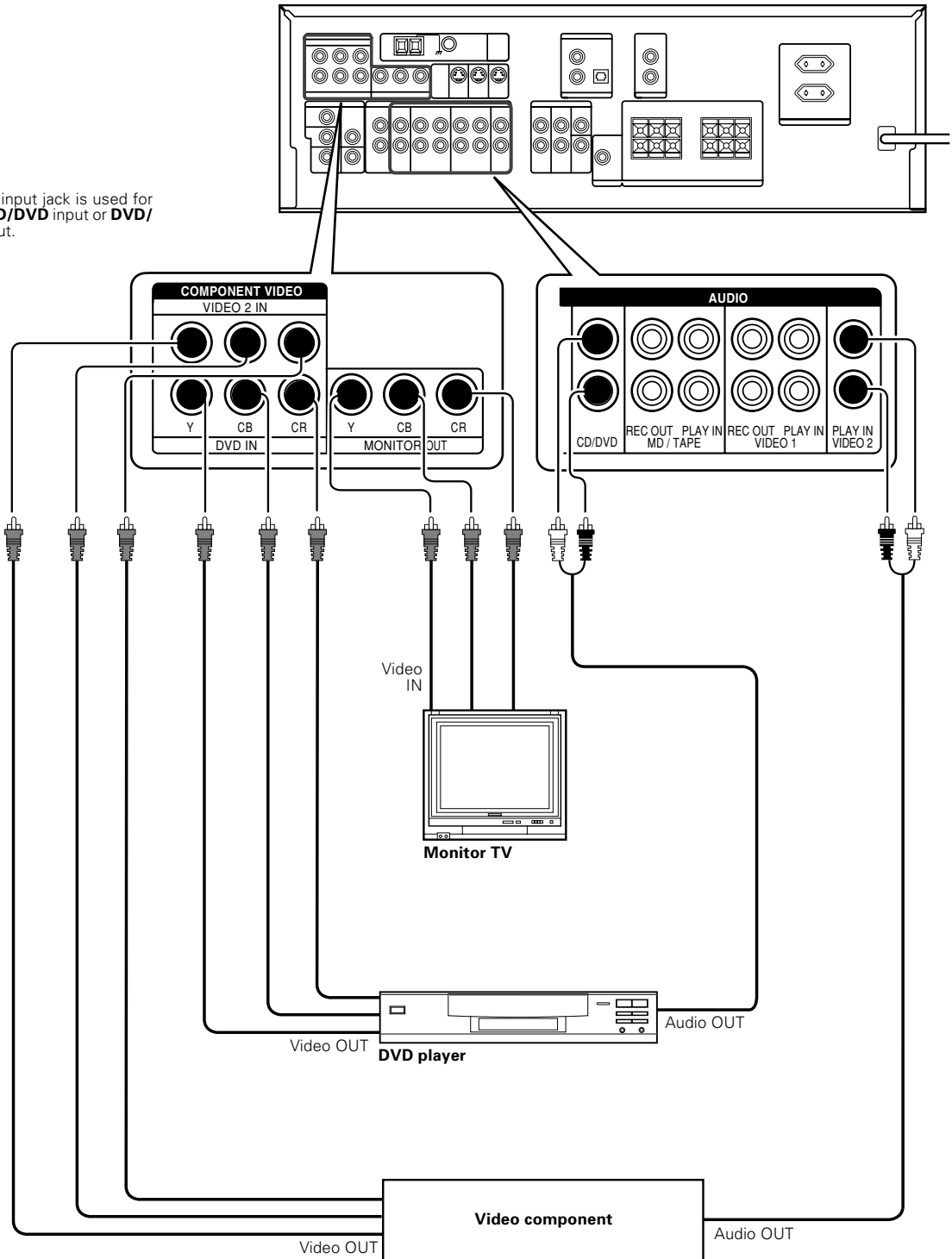

When connecting the TV to the COMPONENT jacks, be sure to connect all the other components to the COMPONENT jacks.

Digital connections

The digital in jacks can accept DTS, Dolby Digital, or PCM signals. Connect components capable of outputting DTS, Dolby Digital, or standard PCM (CD) format digital signals.

If you have connected any digital components to this model, be sure to read the "Input mode settings" section carefully.

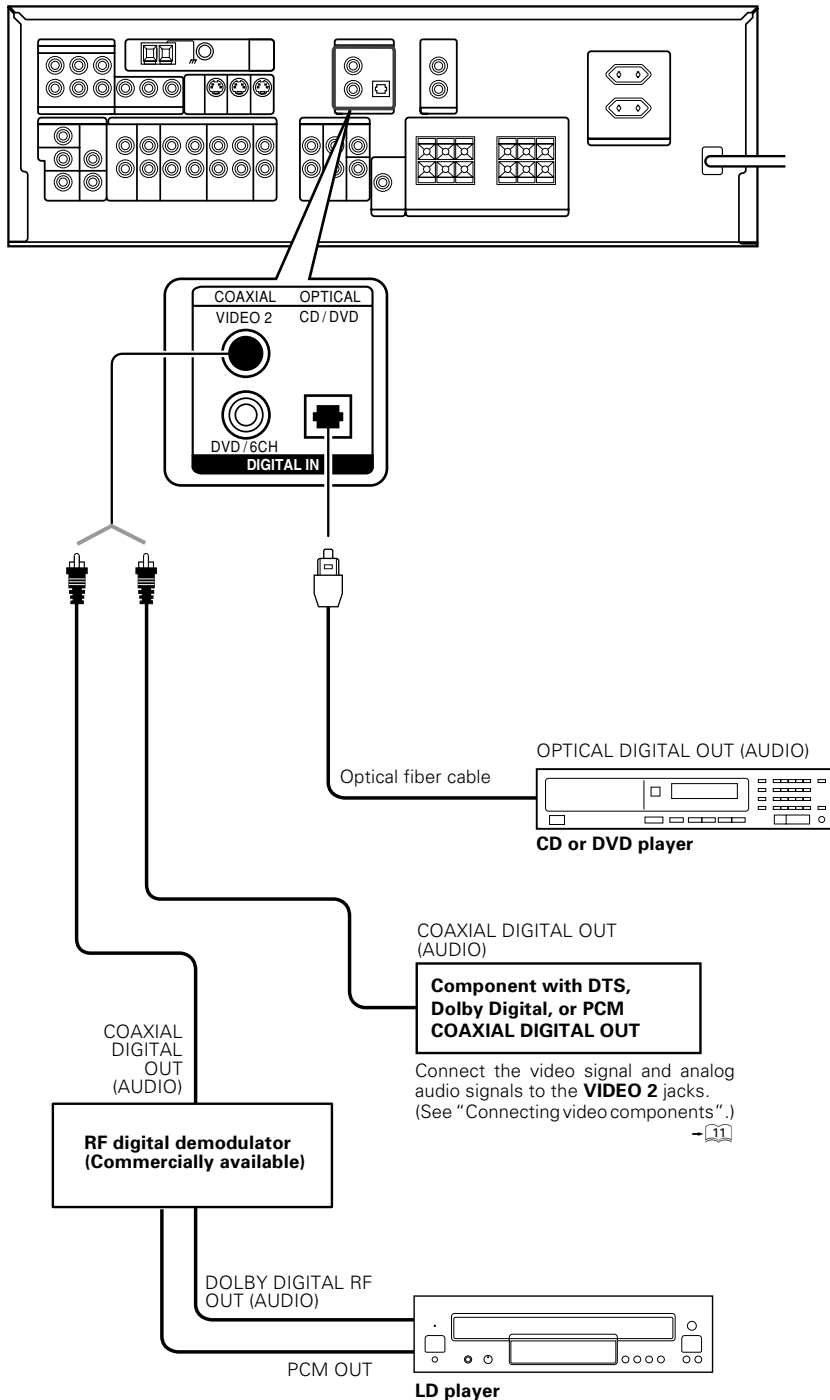

To connect an LD player with a DIGITAL RF OUT, connect the LD player to the RF digital demodulator (Commercially available). Next, connect the DIGITAL OUT jacks of the demodulator to the DIGITAL IN jacks of this model. Connect the video signal and analog audio signals to the VIDEO 2 jacks. (See "Connecting video components". - 11)

Connecting the speakers

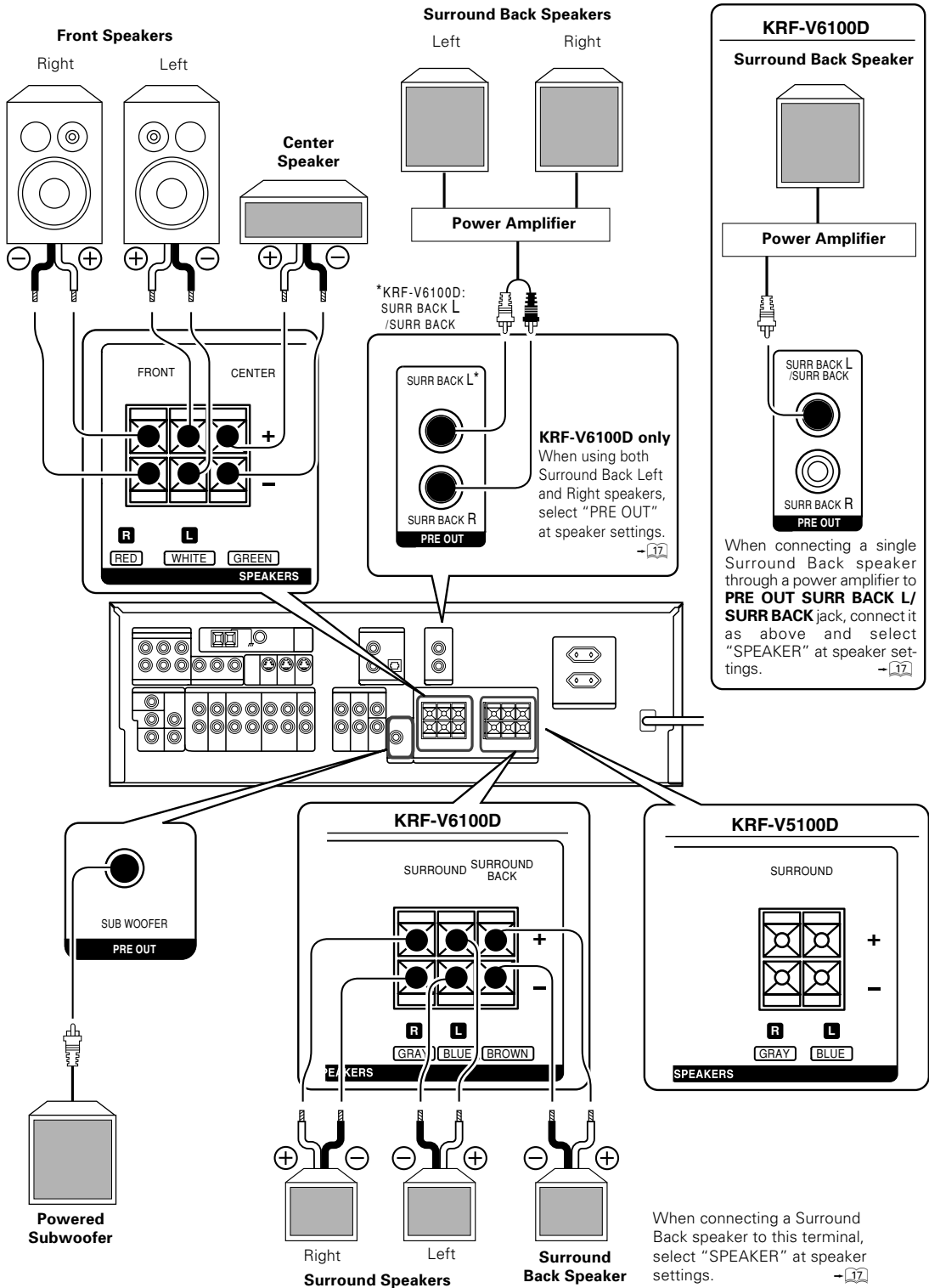

To make sure that each speaker has been connected properly, pay attention to the test tone from each speaker. Refer to "Adjust the speaker volume level."

Connecting the terminals

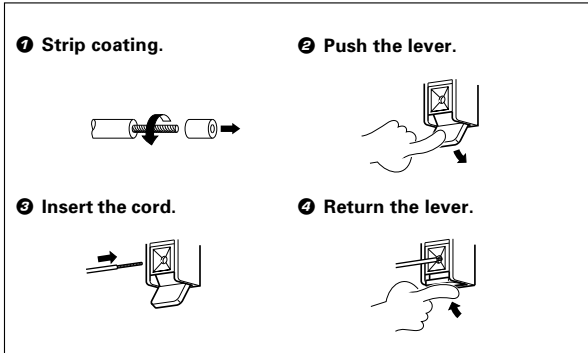

- Never short circuit the + and – speaker cords.
- If the left and right speakers are connected inversely or the speaker cords are connected with reversed polarity, the sound will be unnatural with ambiguous acoustic imaging. Be sure to connect the speakers correctly.

Speaker impedance

After confirming the speaker impedance indications printed on the rear panel of this model, connect speakers with matching impedance ratings. Using speakers with a rated impedance other than that indicated on the rear panel of this model could result in malfunctions or damage to the speakers or this model.

Speaker placement

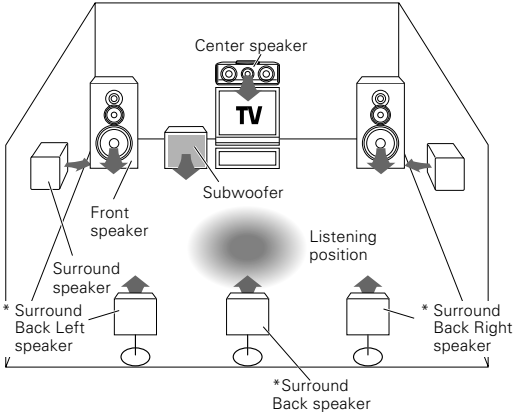

*For Surround Back speaker, you may place either two Surround Back speakers (Surround Back Left speaker and Surround Back Right speaker) for 7.1 channel surround sound system or one Surround Back speaker for 6.1 channel surround sound system.

Front speakers: Place the left and right speakers at each side of your TV. Angle the speakers towards the listening area to enhance the stereo effect.

Center speaker: Place the center speaker on the center between the front left and right speakers. Tilt the speaker upward or downward so that it is directly facing the listening area.

Surround speakers: Place the surround speakers as high as possible, either directly to the sides of the listening area or else slightly behind the listening area. Adjust the angles so that these speakers are facing directly towards the listeners.

Subwoofer: Usually, place the subwoofer in the front center position in the listening room, near one of the front speakers. (Since the subwoofer has less directivity than other speakers, it can be placed almost in any position that can offer the best low frequency reproduction according to the room layout.)

Surround Back speaker/s: Place the surround back speaker behind the listening position, at the same height as the left and right surround speakers.

- Although the ideal surround system consists of all the speakers listed above, if you don't have a center speaker or a subwoofer, you can divide those signals between the available speakers in the speaker settings steps to obtain the best possible surround reproduction from the speakers you have available.

Connecting the antennas

The broadcast reception cannot be made unless the antennas are connected. Connect the antennas correctly as instructed below.

AM loop antenna

Place the supplied loop antenna as far as possible from the receiver, TV set, speaker cords and power cord, and adjust the direction for best reception.

AM antenna terminal connections

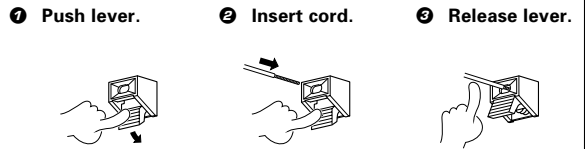

FM indoor antenna

The supplied indoor antenna is for temporary use only. For stable signal reception we recommend using an outdoor antenna. Disconnect the indoor antenna when you connect one outdoors.

FM antenna terminal connections

Insert cord.



FM outdoor antenna

Lead the 75Ω coaxial cable connected to the FM outdoor antenna into the room and connect it to the **FM 75Ω** terminal.

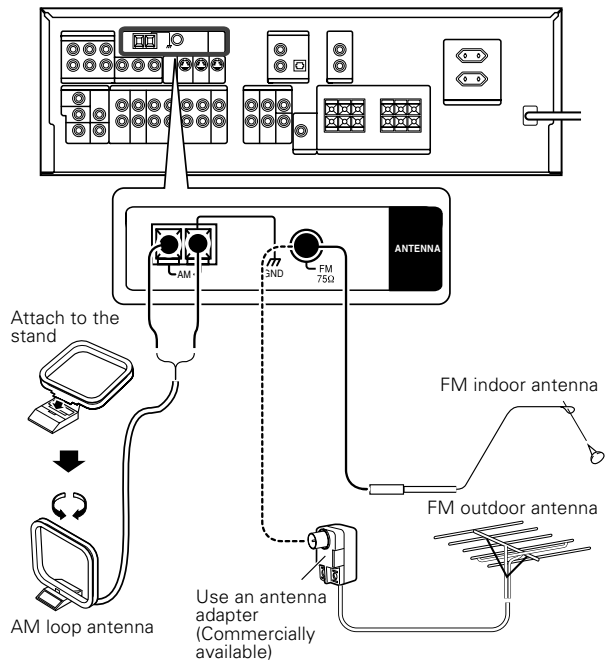

Preparing for surround sound

Speaker settings

To enable you to obtain optimum enjoyment from this model's listening modes, make sure to complete the speaker settings (Subwoofer, Front, Center, Surround and Surround Back speakers) as described below.

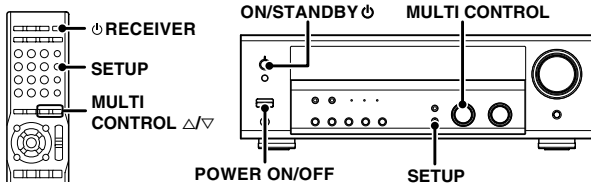

1 Turn on the power to this model by pressing **POWER ON/OFF** and **ON/STANDBY** or **RECEIVER** key.

If you want to use the remote control unit, press the **TUNER**, **MD/TAPE**, **VIDEO 1**, **VIDEO 2** or **AUX** key on the remote control unit to set it to the receiver control mode.

2 Initiate the setup mode.

- 1 Press the **SETUP** key.
- 2 Use the **MULTI CONTROL** knob or **MULTI CONTROL** Δ/∇ keys for the following displays.
 - 1 SP SETUP
 - 2 TESTTONE
 - 3 DISTANCE
 - 4 LFE LVL
 - 5 EXIT

The flow of the SETUP is as follows;

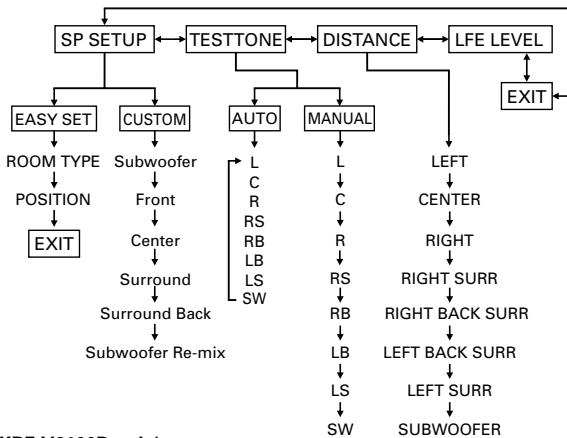

(KRF-V6100D only)

- If you have selected "SPEAKER" as the Surround Back setting, "RB"/"RIGHT BACK SURR" and "LB"/"LEFT BACK SURR" are not appeared but "BS"/"BACK SURR" is appeared on the display.

3 Select the setup method.

- 1 Select "SP SETUP" and press the **SETUP** key to select the speaker setup method.
- 2 Use the **MULTI CONTROL** knob or **MULTI CONTROL** Δ/∇ keys to select "EASY SET" or "CUSTOM" and press the **SETUP** key again.

- 1 **EASY SET** : Select for the simplified speaker setup according only to the room type and listening position. After this, continue the procedure from step 4.
- 2 **CUSTOM** : Select to set up the speakers according to the speaker system in use. Speaker setup is required every time after the speaker system is changed. When the setting "CUSTOM" is selected, the procedure skips to step 4 (When the "CUSTOM" has been selected).

4 When the "EASY SET" has been selected.

The speaker system can be complete by simply selecting the room type and listening position. The audio will be corrected automatically according to the characteristics of the KENWOOD speaker system in use.

- The speaker setup of each models is shown as below:

- KRF-V6100D: 6.1ch surround system
- KRF-V5100D: 5.1ch surround system

- 1 Use the **MULTI CONTROL** knob or **MULTI CONTROL** Δ/∇ keys to select the room type and press the **SETUP** key.
 - "ROOM TYPE" is displayed by scrolling, and then the current setup is displayed.



Select a room type:

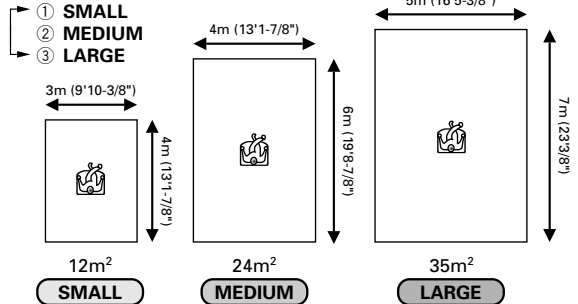

*Indicated sizes are based on an average situation.

- 2 Use the **MULTI CONTROL** knob or **MULTI CONTROL** Δ/∇ keys to select the listening position and press the **SETUP** key.

- "POSITION" is displayed by scrolling, and then the current setup is displayed.



Select a listening position:

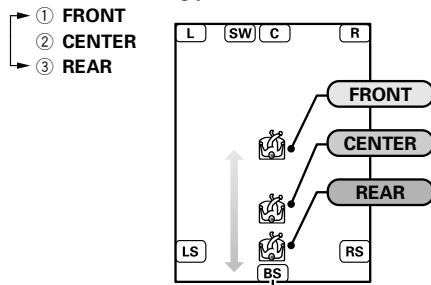

KRF-V6100D only

- 3 Setup is complete when the "EXIT" indication appears.

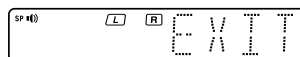

- 4 Press the **SETUP** key to exit the SETUP mode.

Note

The speaker setup with "EASY SET" may not be appropriate with certain speaker systems or listening environment. In this case, use "CUSTOM" for the speaker setup.

5 When the "CUSTOM" has been selected.

1 For general speaker setting, use the MULTI CONTROL knob or MULTI CONTROL Δ/∇ keys to select "CUSTOM" and press the SETUP key again.

- The Subwoofer setting indication "SUBW ON" appears.

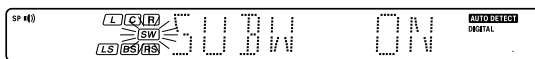

2 Use the MULTI CONTROL knob or MULTI CONTROL Δ/∇ keys to select the appropriate Subwoofer setting.

- 1** SUBW ON : Subwoofer setting mode to this model is ON.
- 2** SUBW OFF : Subwoofer setting mode to this model is OFF.

- The initial setting is "SUBW ON".
- When the setting "SUBW OFF" is selected, the Front speakers are automatically set to "FRNT LRG" and the procedure skips to step **3**.
- Before step **3**, press the SETUP key to accept the setting.
- When Subwoofer output sound is required, select "FRNT NML".

3 Press the SETUP key to accept the setting.

- The Front speakers setting indication "FRNT LRG" appears.

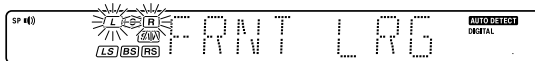

4 Use the MULTI CONTROL knob or MULTI CONTROL Δ/∇ keys to select the appropriate Front speakers setting.

- 1** FRNT LRG (large) : Large Front speakers are connected to this model.
- 2** FRNT NML (normal) : Average size Front speakers are connected to this model.

- For "FRNT LRG" selection, no sound will be heard from Subwoofer speaker even when it is set to ON. However, if you select "SW RE-MIX ON" when Subwoofer is selected, you will be able to hear sound from the Subwoofer.
- When in STEREO mode, the sound goes directly to Front speaker.

5 Press the SETUP key to accept the setting.

- The Center speaker setting indication "CNTR NML" appears.

6 Use the MULTI CONTROL knob or MULTI CONTROL Δ/∇ keys to select the appropriate Center speaker setting.

If you have selected "LRG" as the Front speakers setting:

- 1** CNTR NML (normal) : An average size Center speaker is connected to this model.
- 2** CNTR LRG (large) : A large Center speaker is connected to this model.
- 3** CNTR OFF : Center speaker setting mode to this model is OFF.

If you have selected "NML" as the Front speakers setting:

- 1** CNTR NML (normal) : An average size Center speaker is connected to this model.
- 2** CNTR OFF : Center speaker setting mode to this model is OFF.

7 Press the SETUP key again to accept the setting.

- The Surround speaker setting indication "SURR NML" appears.

8 Use the MULTI CONTROL knob or MULTI CONTROL Δ/∇ keys to select the appropriate Surround speaker setting.

If you have selected "LRG" as the Center speaker setting:

- 1** SURR NML (normal) : Average size Surround speakers are connected to this model.
- 2** SURR LRG (large) : Large Surround speakers are connected to this model.
- 3** SURR OFF : Surround speaker setting mode to this model is OFF.

If you have selected other than "LRG" as the Center speaker setting:

- 1** SURR NML (normal) : Average size Surround speakers are connected to this model.
- 2** SURR OFF : Surround speaker setting mode to this model is OFF.

- When the setting "SURR OFF" is selected, the procedure skips to step **7**.

9 Press the SETUP key to accept the setting.

- The Surround Back speaker setting indication "BS" appears.

10 Use the MULTI CONTROL knob or MULTI CONTROL Δ/∇ keys to select the appropriate Surround Back speaker setting.

If you have selected "LRG" as the Surround speaker setting:

- 1** BS NML (normal) : Average size Surround Back speaker is connected to this model.
- 2** BS LRG (large) : Large Surround Back speaker is connected to this model.
- 3** BS OFF : Surround Back speaker setting mode to this model is OFF.



If you have selected "NML" as the Surround speaker setting:

- 1** BS NML (normal) : Average size Surround Back speaker is connected to this model.
- 2** BS OFF : Surround Back speaker setting mode to this model is OFF.

(KRF-V6100D only)

If you have selected "NML" or "LRG" as the Surround Back speaker setting:

- 1** SPEAKER : Surround Back signal will be output from SURROUND BACK speaker terminal and PRE OUT SURR BACK L/SURR BACK jack as monaural.
- 2** PRE OUT : Surround Back signals will be out put from PRE OUT SURR BACK L/SURR BACK and PRE OUT SURR BACK R jacks as stereo.

11 Press the SETUP key again to accept the setting.

- The Subwoofer re-mix setting indication "SW RE-MIX" scrolls across the display.

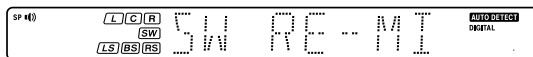

- If Subwoofer is turned OFF, Subwoofer re-mix setting is not visible.

12 Use the MULTI CONTROL knob or MULTI CONTROL Δ/∇ keys to select the appropriate Subwoofer re-mix setting.

- 1** RMX ON : Subwoofer re-mix set mode to this model is ON.
- 2** RMX OFF : Subwoofer re-mix set mode to this model is OFF.

13 Press the SETUP key to accept the setting.

6 Adjust the speaker volume level.

From your usual listening position, adjust the volume levels. The volume levels from each speaker should be the same.

- In step 6 and 7, indications appear only for the selected channels of the speakers that require adjusting.

1 Press the SETUP key to begin TEST TONE.

- This model enters the speaker volume level adjustment mode.

The selection of AUTO/MANUAL TEST TONE is done by the MULTI CONTROL knob or MULTI CONTROL Δ/∇ keys.

- ① AUTO
- ② MANUAL

2 Press the SETUP key again to select either "AUTO" or "MANUAL".

Use the MULTI CONTROL knob or MULTI CONTROL Δ/∇ keys to adjust the volume level of the test tone output from the speaker channel to be adjusted.

For "AUTO" selection, the test tone is heard from the speakers in the following sequence for 2 seconds each:

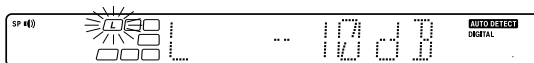
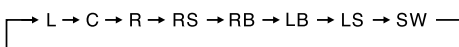

- If you change the volume level settings for the speakers while listening to music, the settings referred to on this page are also changed.
- If any of the speaker is set as OFF during SP SETUP, the TEST TONE adjustment for the speaker will be skipped.

(KRF-V6100D only)

- If you have selected "SPEAKER" as the Surround Back setting, "RB" and "LB" are not appeared but "BS" is appeared on the display.

3 Press the SETUP key.

- The test tone is turned off. This model enters the mode for inputting the distance to the speakers.

4 For "MANUAL" selection, press the SETUP key each time to select the speaker channel.

7 Input the distance to the speakers.

1 Select the "DISTANCE" from the setup displays and press the SETUP key again.

2 Measure the distance from the listening position to each of the speakers.

jot down the distance to each of the speakers:

| | |
|--------------------------------------|----------------------|
| Distance to Front Left speaker (L) | : ____ feet (meters) |
| Distance to Center speaker (C) | : ____ feet (meters) |
| Distance to Front Right speaker (R) | : ____ feet (meters) |
| Distance to Surround Right (RS) | : ____ feet (meters) |
| Distance to Surround Back Right (RB) | : ____ feet (meters) |
| Distance to Surround Back (BS) | : ____ feet (meters) |
| Distance to Surround Back Left (LB) | : ____ feet (meters) |
| Distance to Surround Left (LS) | : ____ feet (meters) |
| Distance to Subwoofer (SW) | : ____ feet (meters) |

(KRF-V6100D only)

- If you have selected "SPEAKER" as the Surround Back setting, "RB"/"RIGHT BACK SURR" and "LB"/"LEFT BACK SURR" are not appeared but "BS"/"BACK SURR" is appeared on the display.

3 Use the MULTI CONTROL knob or MULTI CONTROL Δ/∇ keys to select the distance to the Front speakers.

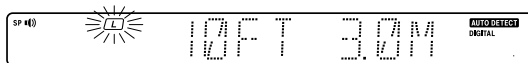

Indication in feet Indication in meters

- The allowable setting range is 1 to 30 feet (0.3m to 9.0m), adjustable in 1 foot (0.3m) increments.

4 Press the SETUP key to accept the settings.

5 Repeat steps 3 and 4 to input the distance for each of the speakers.

8 Adjust the LFE LEVEL (Low Frequency Effects level)

1 Select the "LFE LVL" from the setup displays and press the SETUP key again.

2 Use the MULTI CONTROL knob or MULTI CONTROL Δ/∇ keys to adjust the LFE LEVEL.



- The LFE LEVEL is adjusted from 0dB to -10dB in 1dB step decrements.

3 Press the SETUP key to accept the setting.

4 Setup is complete when the "EXIT" indication appears.

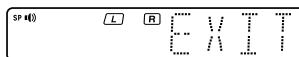

- The speakers you have selected should appear on the display. Confirm that all the speakers have been correctly selected.

5 Press the SETUP key to exit the SETUP mode.

Input level adjustment (analog sources only)

If the input level of an analog source signal is too high, the CLIP indicator will blink to indicate the source signal. Adjust the input level.



1 Use the INPUT SELECTOR knob to select the source of which the input level you want to adjust.

- You can store a separate input level for each input source.

2 Press the SOUND key repeatedly until the "INPUT" indication appears.

3 Use the MULTI CONTROL knob or MULTI CONTROL Δ/∇ keys to adjust the input level.



- The input level may be adjusted to any one of three settings: 0dB, -3dB, and -6dB. (The initial setting is 0dB.)

4 Press the SOUND key again to return to the input indication.

Normal playback

Preparing for playback

Some preparatory steps are needed before starting playback.

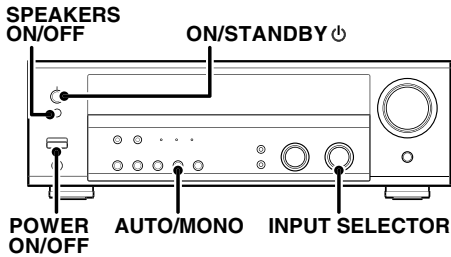

Turning on this model

- 1 Turn on the power to the related components.
- 2 Turn on the power to this model by pressing the POWER ON/OFF and ON/STANDBY key.

Selecting the input mode

If you have selected a component connected to the CD/DVD, VIDEO2, DVD/6CH INPUT jacks, make sure that the input mode setting is correct for the type of audio signal to be used. 

Selecting MD/TAPE

Select the source name corresponding to the component connected to the MD/TAPE jacks. The initial factory setting is "TAPE". To change the source to "MD", follow the steps below:

- 1 Use the INPUT SELECTOR knob to select "TAPE".
- 2 Hold down the AUTO/MONO key for more than 2 seconds.
 - The source indication changes to "MD".
 - To return to the original indication, repeat procedure 2.

Setting the speaker status

The speaker indicator lights up.

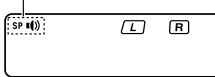

Press the SPEAKERS ON/OFF key to switch the speaker on or off.

Listening to a source component

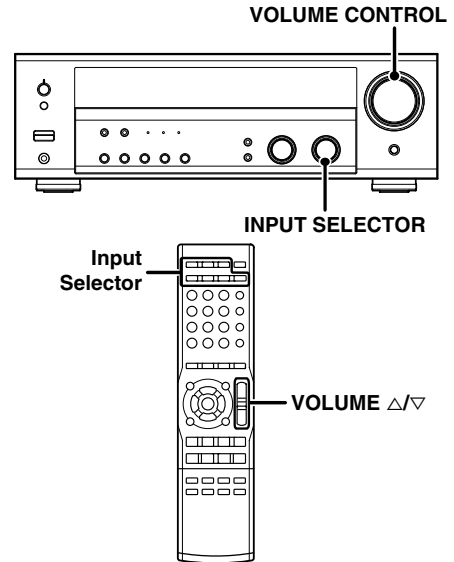

- 1 Use the INPUT SELECTOR knob or keys to select the source you want to listen to.

The input sources change as shown below:

- 1 Tuner (FM/AM broadcast reception)
- 2 "CD/DVD"
- 3 "TAPE" or "MD"
- 4 "VIDEO1"
- 5 "VIDEO2"
- 6 "DVD/6CH"
- 7 "AUX"

- 2 Start playback from the selected source.

- 3 Use the VOLUME CONTROL knob or VOLUME Δ/∇ keys to adjust the volume.

Adjusting the sound

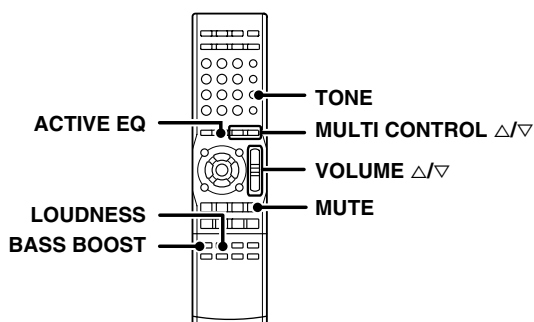
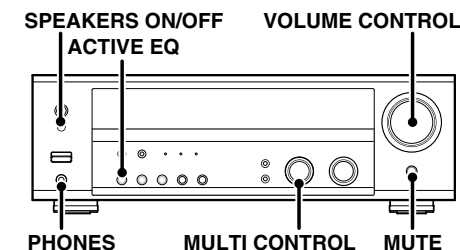

Adjusting the Tone (remote control only)

You can adjust the sound quality when this model is in the PCM stereo and analog stereo mode.

- 1 Press the **TONE** key to select the Tone mode.
- 2 Use the **MULTI CONTROL** knob or **MULTI CONTROL Δ/∇** keys to select "TONE ON" or "TONE OFF".



- 3 When in "TONE ON" selection, press the **TONE** key for the following displays.
BASS : Select this to adjust the low frequency range.
TREB : Select this to adjust the high frequency range.

- 4 Use the **MULTI CONTROL** knob or **MULTI CONTROL Δ/∇** keys to adjust the sound quality.



- The bass and treble levels are adjustable from -10 to +10 in 2 step increments.
- When the ACTIVE EQ mode is set to ON, set it to OFF and then control the TONE setting.

One-touch low frequency emphasis (Bass Boost) (remote control only)

You can adjust the sound quality when this model is in the PCM stereo and analog stereo modes.

Press the BASS BOOST key.

- Press the key once to select the maximum (+10) low frequency emphasis setting.
- TONE will automatically be turned ON.
- This key does not function when this model is in the sound quality or ambience effects adjustment mode. — [26] ~ [31]
- When the ACTIVE EQ mode is set to ON, set it to OFF and then control the BASS BOOST setting.

Switching back to the previous setting

Press the **BASS BOOST** key again.

Adjusting the Loudness mode (remote control only)

You can adjust the Loudness function which controls the low volume settings to maintain the music's richness. The adjustment can be made when this model is in the PCM stereo and analog stereo mode.

Press the **LOUDNESS** key to turn the Loudness setting ON.

To cancel

Press the **LOUDNESS** key again so that the "LOUDNESS" indicator goes off.

Muting the sound

The **MUTE** key lets you mute the sound of the speakers.

Press the **MUTE** key.

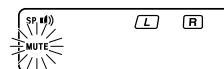

To cancel

Press the **MUTE** key again so that the "MUTE" indicator goes off.

- MUTE ON can also be deactivated by turning the **VOLUME CONTROL** knob (or pressing the **VOLUME Δ/∇** keys).

ACTIVE EQ mode

You can enjoy a more impressive sound effect when ACTIVE EQ is turned ON during Dolby Digital and DTS playback and, when in PCM and analog stereo mode.

Press the **ACTIVE EQ** key for the following selections;

- 1 **ACTIVE EQ MUSIC** : Effective when listening to music. (The ACTIVE EQ LED indicator lights up.)
- 2 **ACTIVE EQ CINEMA** : Effective when watching a movie. (The ACTIVE EQ LED indicator lights up.)
- 3 **ACTIVE EQ TV** : Effective when watching TV. (The ACTIVE EQ LED indicator lights up.)
- 4 **ACTIVE EQ OFF** : The ACTIVE EQ function is turned OFF. (The ACTIVE EQ LED indicator goes off.)

- ACTIVE EQ function will not be available when REC MODE, AUTO TUNING or PRESET MEMORY is ON and during 96kHz LPCM playback.

Listening with headphones

- 1 Press the **SPEAKERS ON/OFF** key so that the speaker indicator goes off.

Make sure the SP indicator is turned OFF.

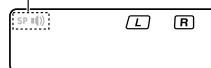

- If you turn off all of the speakers when in surround mode, the surround mode will be canceled as well, resulting in stereo playback.

- 2 Connect headphones to the **PHONES** jack.

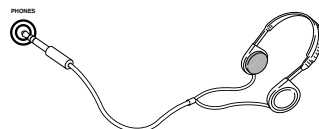

- 3 Use the **VOLUME CONTROL** knob or **VOLUME Δ/∇** keys to adjust the volume.

Recording

Recording audio (analog sources)

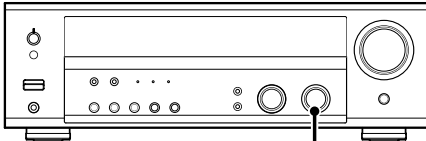

INPUT SELECTOR

Recording a music source

- 1 Use the INPUT SELECTOR knob to select the source (other than "MD/TAPE") you want to record.
- 2 Set the MD or TAPE recorder to record.
- 3 Start playback, then start recording.

Recording video

- 1 Use the INPUT SELECTOR knob to select the video source (other than "VIDEO1") you want to record.
- 2 Set the video deck connected to VIDEO 1 to record.
 - Select the REC MODE to record a digital input source.
- 3 Start playback, then start recording.
 - Recording may not be normal for some video software. This is due to the copy guard condition. → [33]

Recording audio (digital sources)

Switch on the **REC mode** to record a digital input source. Usually use the **A-REC (Auto-Record) mode** to record audio input sources. When the digital mode changes during recording in the **A-REC mode**, the audio input source may be interrupted momentarily.

Recording music in A-REC or M-REC mode

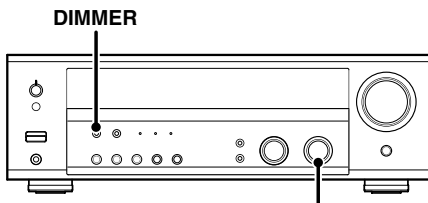

INPUT SELECTOR

- 1 Use the INPUT SELECTOR knob to select the source (CD/DVD, DVD/6CH or VIDEO2) you want to record.
- 2 Set the MD or TAPE recorder to record.

- 3 Press and hold the DIMMER key for more than 2 seconds to select the A-REC or M-REC mode during digital input.

- 1 **Rec mode off** : The digital input record mode is switched off.
- 2 **A-REC mode** : The digital input signals (DTS, Dolby Digital, or PCM) are identified automatically and converted into stereo signals that are ready for recording.
- 3 **M-REC mode** : The input signal type at the moment this mode is selected is held throughout this mode.

- When the **M-REC mode** is selected, the digital input signal is converted to stereo signals (down-mix). But once the digital signal is changed to other signal, no signal is output.
- When the **A-REC mode** is selected, the digital input signal is converted to stereo signals even if the digital signal is changed.

For A-REC mode:

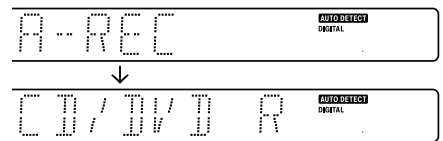

For M-REC mode:

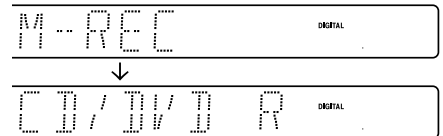

- 4 Start playback, then start recording.
 - If the audio reproduction stops in the middle due to change in the input signals, etc., press the DIMMER key.

Listening to radio broadcasts

This model can store up to 40 stations in the memory and recall them by one-touch operation. Radio stations can be classified into RDS (Radio Data System) stations and other stations. To listen to or store RDS stations in the preset memory see "Using RDS (Radio Data System)".

Tuning (non-RDS) radio stations

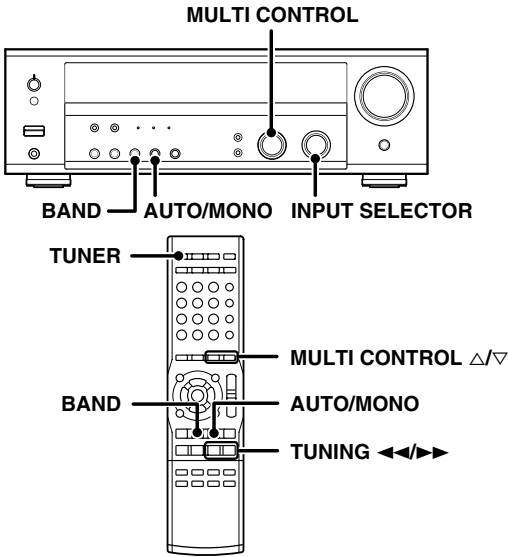

1 Use the **INPUT SELECTOR knob** or **TUNER key** to select the tuner.

2 Use the **BAND key** to select the desired broadcast band.

Each press switches the band as follows:

- ① FM
- ② AM

"AM" or "FM" indicator appears in the display



3 Use the **AUTO/MONO key** to select the desired tuning method.

Each press switches the tuning method as follows:

- ① **AUTO lit** (auto tuning)
- ② **AUTO not lit** (manual tuning)

"AUTO" indicator lights up in the display.

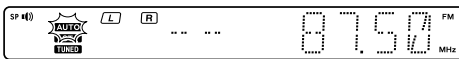

• Normally, set to "AUTO" (auto tuning). If the radio waves are weak and there is a lot of interference, switch to manual tuning. (With manual tuning, stereo broadcasts will be received in monaural.)

4 Use the **MULTI CONTROL knob** or **MULTI CONTROL Δ/∇ keys**, or **TUNING \leftarrow/\rightarrow keys** to select the station.

"ST." lights when a broadcast is being received in stereo.

Frequency display

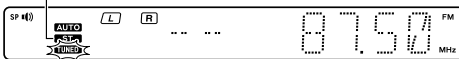

"TUNED" is displayed when a station is received.

Auto tuning : The next station is tuned automatically.

Manual tuning : Turn the knob (press the key) to select the desired station.

Using RDS (Radio Data System)

RDS is a system that transmits useful information (in the form of digital data) for FM broadcasts along with the broadcast signal. Tuners and receivers designed for RDS reception can extract the information from the broadcast signal for use with various functions, such as automatic display of the station name.

RDS functions:

PTY (Program Type Identification) Search

— 25

Automatically tunes to a station that is currently broadcasting the specified program type (genre).

PS (Program Service Name) Display

Automatically displays the station name transmitted by the RDS station.

RDS AUTO MEMORY function

— 25

Automatically selects and stores up to 40 RDS stations in the preset memory.

If fewer than 40 RDS stations have been stored in the preset memory, regular FM stations will be stored in the remaining places.

Radio Text function

Displays the radio text data transmitted by some RDS stations when you press the **RDS DISP.** (Display) key. There is "NO RT" display if no text data is transmitted.

The "RDS" indicator lights up when an RDS broadcast (signal) is received.

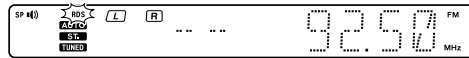

Note

Some functions and function names may differ for certain countries and areas.

Before using a function utilizing the RDS, be sure to perform the RDS Auto Memory operation by referring to the description in "Presetting RDS stations (RDS AUTO MEMORY)".

— 25

Presetting radio stations manually

The RDS auto memory function assigns preset numbers to RDS stations starting from preset number "1". Therefore, be sure to execute the RDS auto memory function before using the following operations to manually store AM stations and other FM stations, and RDS stations. See "Presetting RDS stations (RDS AUTO MEMORY)". 

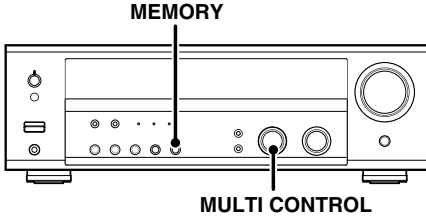

1 Tune to the station you want to store.

2 Press the **MEMORY** key while receiving the station.

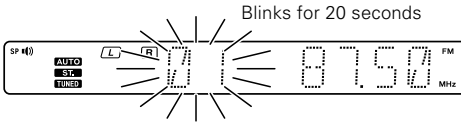

Proceed to step **3** within 20 seconds.
(If more than 20 seconds elapse, press the **MEMORY** key again.)

3 Use the **MULTI CONTROL** knob or **MULTI CONTROL** Δ / ∇ keys to select one of the station presets (1 – 40).

4 Press the **MEMORY** key again to confirm the setting.

- Repeat steps **1**, **2**, **3**, and **4** to store as many stations as necessary.
- If you store a station at a previously used preset, the previous station will be replaced by the new one.

Receiving preset stations

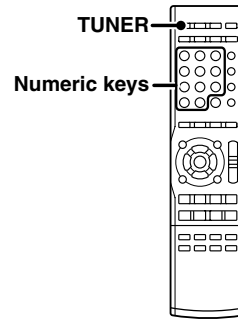

1 Press the **TUNER** key to select tuner as the source.

2 Enter the number of the preset station you want to receive (up to "40").

Press the Numeric keys in the following order:

For "15", press **+10**, **5**

For "20", press **+10**, **+10**, **0**

- If you make a mistake entering a two digit number, press the **+10** key repeatedly to return to the original display and start again.



Receiving preset stations in order (P.CALL)

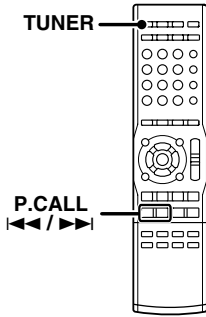

1 Press the **TUNER** key to select tuner as the source.

2 Use the **P.CALL** $\leftarrow \rightarrow \leftarrow \rightarrow$ keys to select the desired station.

- Each time you press the key, another preset station is received in order.

Pressing the **P.CALL** \rightarrow key does the following:

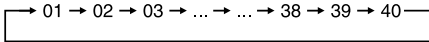

Pressing the **P.CALL** \leftarrow key does the following:

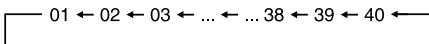

Holding down the **P.CALL** \rightarrow or \leftarrow key, lets you skip through the presets, receiving each preset station at 0.5 second intervals.

Using the RDS DISP. (Display) key

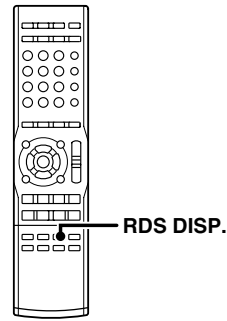

Pressing the **RDS DISP.** key changes the contents of the display.

Each press switches the display mode as follows:

- ① **PS** (Program Service name) display
- ② **RT** (Radio Text) display
- ③ **Frequency** display

1 PS (Program Service name) display:

The station name is displayed automatically when an RDS broadcast is received.

If no PS data was sent, "NO PS" is displayed.



2 RT (Radio Text) display:

Text data accompanying the RDS broadcast scrolls across the display.

"NO RT" or "RT----" is displayed if the current RDS station does not provide RT data.



3 Frequency display:

Displays the frequency of the current station.

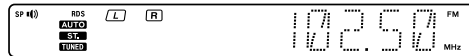

Presetting RDS stations (RDS AUTO MEMORY)

This function automatically stores up to 40 RDS stations in the preset memory. In order to use the PTY function, the RDS stations must be stored in the preset memory using the RDS AUTO MEMORY function.

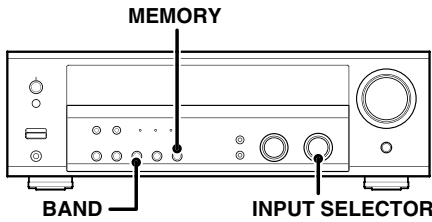

1 Use the **INPUT SELECTOR** knob to select the tuner.

2 Use the **BAND** key to set the broadcast band to "FM".

3 Press and hold the **MEMORY** key for more than 2 seconds.

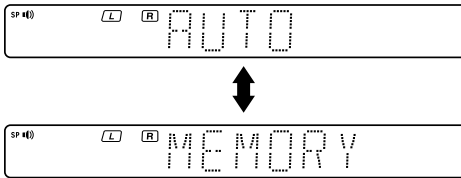

- After a few minutes, up to 40 RDS stations are preset in order from channel "01".
- Stations already stored in the preset memory may be replaced by RDS stations. (i.e., If the RDS AUTO MEMORY function detects 15 RDS stations, the stations currently preset at numbers 01~15 will be replaced by the RDS stations.)

Tuning by Program Type (PTY search)

This function lets you set the tuner to automatically search for stations which are currently broadcasting the type of program (genre) you want to listen to.

Under certain receiving conditions, it may take more than 1 minute to complete the search.

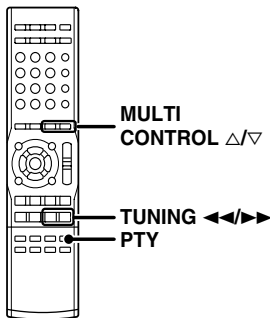

Preparations

- Execute the RDS auto memory procedure.
- Set the broadcast band to FM.
- Tune to an RDS station.

1 Press the **PTY** key to activate the **PTY** search mode.



When an RDS broadcast is received, the program type is shown on the display. If no PTY data is available, or if the station is not an RDS station, "NONE" is displayed.

2 While the "PTY" indicator is lit, use the **MULTI CONTROL** knob or **MULTI CONTROL** Δ/∇ keys, or **TUNING** \leftarrow/\rightarrow keys to select the program type of your choice.

Program type table

| Program Type Name | Display | Program Type Name | Display |
|-------------------------|----------|--------------------|----------|
| Pop Music | POP M | Weather | WEATHER |
| Rock Music | ROCK M | Finance | FINANCE |
| Easy Music | EASY M | Children's Program | CHILDREN |
| Light Classical Music | LIGHT M | Social Affairs | SOCIAL |
| Serious Classical Music | CLASSICS | Religion | RELIGION |
| Other Music | OTHER M | Phone In | PHONE IN |
| News | NEWS | Travel | TRAVEL |
| Current Affairs | AFFAIRS | Leisure | LEISURE |
| Information | INFO | Jazz Music | JAZZ |
| Sport | SPORT | Country Music | COUNTRY |
| Education | EDUCATE | National Music | NATION M |
| Drama | DRAMA | Oldies Music | OLDIES |
| Culture | CULTURE | Folk Music | FOLK M |
| Science | SCIENCE | Documentary | DOCUMENT |
| Varied Speech | VARIED | | |

"NO PROG" is displayed if this operation is attempted before performing the RDS Auto Memory operation.

3 Press the **PTY** key to start searching.

EXAMPLE: Searching for a Rock Music broadcast.

Display while searching.

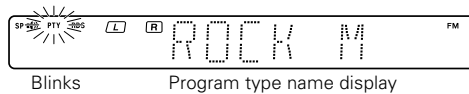

Display when a station is received.
Goes out

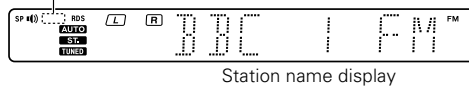

- No sound is heard while "PTY" is blinking.
- If the desired program type cannot be found, "NO PROG" is displayed, then after several seconds the display returns to the original display.

To select another program type
Repeat steps 1, 2 and 3.

Ambience effects

This model is equipped with listening modes that allow you to enjoy an enhanced sonic ambience with a variety of video sources.

In order to obtain the optimum effect from the surround modes, make sure to input the proper speaker settings beforehand.

Surround modes

The below speaker placements are for 5.1 channel surround sound system which are;

- Dolby Digital
- Dolby Pro Logic II
- DTS
- DSP
- DVD 6-channel

The below speaker placements are for 6.1 channel surround sound system which are;

- Dolby Digital EX
- DTS-ES
- NEO:6

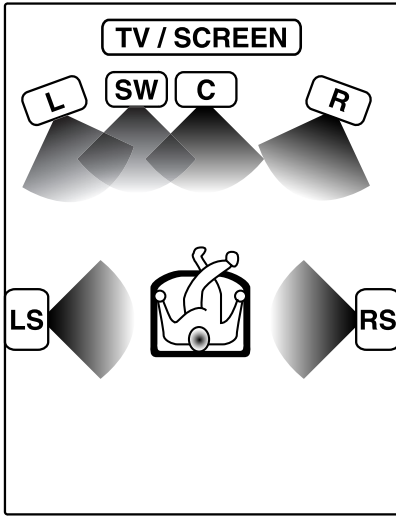

No Surround Back speaker

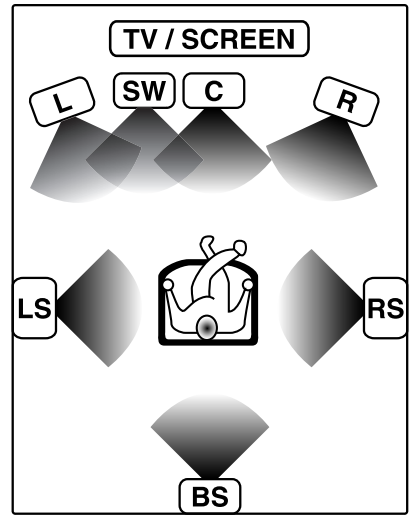

With Surround Back speaker

The below speaker placements are for 7.1 channel surround sound system which is;

- Dolby Pro Logic IIx

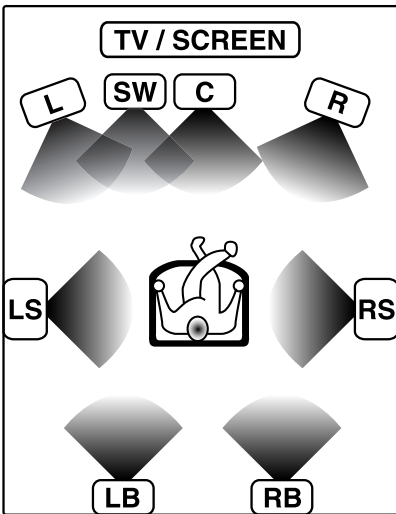

With Surround Back Left and Right speakers

- L** Front Left speaker
- SW** Subwoofer
- C** Center speaker
- R** Front Right speaker
- LS** Surround Left speaker
- RS** Surround Right speaker
- BS** Surround Back speaker
- LB** Surround Back Left speaker
- RB** Surround Back Right speaker

Manufactured under license from Dolby Laboratories. "Dolby", "Pro Logic", "Surround EX" and the double-D symbol are trademarks of Dolby Laboratories.

"DTS", "DTS-ES Extended Surround" and "Neo:6" are trademarks of Digital Theater Systems, Inc.



Note

LFE = Low Frequency Effects. This channel delivers separate non-directional bass signals to the subwoofer for more dynamic deep bass sound effects.

Dolby Digital

The Dolby Digital surround format lets you enjoy up to 5.1 channels of digital surround sound from Dolby Digital program sources (such as Laserdisc or DVD software marked ). Compared with previous Dolby surround, Dolby Digital provides even better sound quality, greater spatial accuracy, and improved dynamic range.

Although a full set of speakers (front left, right, and center, surround left and right, and a subwoofer) is required for true 5.1 channel Dolby Digital surround sound, this model lets you enjoy Dolby Digital (and Dolby Surround) program sources, even if you connect only the front speakers.

Dolby Digital EX

Dolby Digital EX is an extension of Dolby Digital technology. Dolby Digital EX creates six full-bandwidth output channels from 6.1-channel sources. This is done using a matrix decoder that derives three surround channels from the two in the original recording. This is achieved by using three different surround signals, surround left, surround right, and surround back, each driving its own array of speakers. Think of it as adding a center channel for the rear speakers, which give more diffuse and natural surround effect, even if you wanted the ability to completely encircle the audience with sound, positioning sound effects exactly where they would be heard in real life. For best results, Dolby Digital EX should be used with movie soundtracks recorded with Dolby Digital Surround EX which contain a digital flag that will automatically activate this feature. However, for titles released prior to late 2001, this feature has to be activated manually.

Although a full set of speakers (front left, right, and center, surround left and right, surround back and a subwoofer) is required for true 6.1 channel Dolby Digital Surround EX sound, this model lets you enjoy Dolby Digital (and Dolby Surround) program sources, even if you connect only the front speakers.

Although only Dolby Digital soundtracks incorporate a separate low frequency channel, connecting a subwoofer will also improve deep bass performance in the other surround modes.

Dolby Digital has a “.1” or **LFE** channel.

The indication “**LFE**” appears in the display when a signal is being input for this channel. - [26]

Dolby Pro Logic IIx and Dolby Pro Logic II

Dolby Pro Logic II was designed specifically to provide a new sense of spatiality, directionality and articulation of sounds from Dolby Surround encoded sources (such as video and Laserdisc software marked ). This is achieved with an intelligent, built-in feedback logic design, a matrix surround decoding and the decoding of stereo, full bandwidth surround outputs.

Dolby Pro Logic IIx enhanced Dolby Pro Logic II's features. It creates 6.1 channel and 7.1 channel surround sound from stereo or 5.1 channel signals. This feature provides you an astonishing ambience effect which makes you feel you are surrounded by natural sound. Especially 7.1 channel surround sound can produce real back sound from Surround Back speakers.

The Pro Logic IIx modes programmed into this model are “MOVIE”, “MUSIC” and “GAME”. The Pro Logic II modes programmed into this model are “MOVIE”, “MUSIC”, “GAME” and “PRO LOGIC”. The “MOVIE” mode has preset characteristics to produce a calibrated, high-level surround sound playback while the “MUSIC” mode has user-adjustable characteristics to offer the three optional controls, like “Dimension”, “Center Width” and “Panorama” modes to allow optimization of the soundfields as desired. The “Dimension” control allows the user to gradually adjust the soundfield either towards the front or towards the rear; the “Center Width” control allows various adjustment of the left-center-right speakers' balance; the “Panorama” mode extends the front stereo image to include the surround speakers for an exciting “wraparound” effect with side wall imaging. The “GAME” mode provides surrounded and exciting sound when you enjoy game or TV. Especially in Pro Logic IIx “GAME” mode, base sound not only from Front and Center but also from Surround channel is added to Subwoofer. This provides even more dynamic surround effects.

DTS-ES

DTS-ES (Digital Theater System-Extended Surround) presents 6.1 channels surround system with additional Surround Back channel which evolved from the conventional 5.1 channels surround system. DTS-ES format that was recorded in DVD, CD or LD comprises of two modes. DTS-ES Discrete 6.1 produces the discrete surround back which is completely independent and DTS-ES Matrix 6.1 produces the surround back which synthesised within the left and right surround channels using matrix technology. DTS-ES has perfect compatibility with the conventional 5.1 channels surround system. 6.1 channels surround with an additional surround back presents a more natural presence and surround effects by increasing the impression of the sound image from back. Programs which are recorded using DTS-ES technology consist of information flags which will be able to control the Discrete and Matrix mode. Thus, it can automatically select the best matched mode.

Neo:6

Neo:6 is a new technology which was developed by DTS. It can produce high grade 6 channels surround with an astonishing fidelity from 2 channels content. Neo:6 has 2 modes, “CINEMA” mode is for movie playback and “MUSIC” mode is for music playback.

DTS has a “.1” or **LFE** channel.

The indication “**LFE**” appears in the display when a signal is being input for this channel. - [26]

DTS

The DTS multi-channel audio format is available on CD, LD and DVD software. DTS is a strictly digital format and cannot be decoded inside most CD, LD or DVD players. For this reason, if you attempt to listen to DTS encoded software through the analog output of your new CD, LD or DVD player, you will experience digital noise in most cases. This noise can be quite loud if the analog output is connected directly to a high power amplification system. Proper measures for playing the digital output as described below should be taken to avoid this situation. To enjoy DTS Digital Surround playback, an external 5.1 channel DTS Digital Surround decoder system or an amplifier with a built-in DTS Digital Surround decoder must be connected to the digital output (S/P DIF, AES/EBU or TosLink) of a CD, LD or DVD player.

All models are incorporated with the DTS decoder.

DTS has a “.1” or **LFE** channel.

The indication “**LFE**” appears in the display when a signal is being input for this channel. - [26]

DSP mode

The DSP mode lets you add the atmosphere of a live concert or hall to almost any type of program source. These modes are particularly effective when used with stereo program sources, like CD, television, and FM radio. You might enjoy trying the ARENA, JAZZ CLUB, THEATER, STADIUM or DISCO mode the next time you watch a concert or sporting event!

What's DSP?

DSP stands for Digital Signal Processor.

The way a sound is heard in an actual environment depends on a variety of different factors. One of the most important is reverberation (the act of decaying elements of sound echoing in various places). The DSP modes produce the feeling of presence by using the DSP to create reverberation, without spoiling the sound quality of the original signal.

DVD 6-channel mode

Using a DVD player or the like equipped with six (5.1) output channels and this model, you can enjoy multi-channel encoded DVD source material in all its splendor. Since the source signals are digital and each channel is input independently, the resulting sound quality, sense of spaciousness, and dynamic range are superb.

The indication “**6CH INPUT**” appears in the display during DVD 6-channel mode selection.

Surround play

The DTS compatible models can reproduce a CD, DVD, or LD carrying the DTS mark.

Dolby Digital can be used when playing DVD or LD software bearing the **DD** mark and Dolby Digital format digital broadcasts (etc.).

Dolby Pro Logic can be used when playing video, DVD, or LD software bearing the **DL** mark.

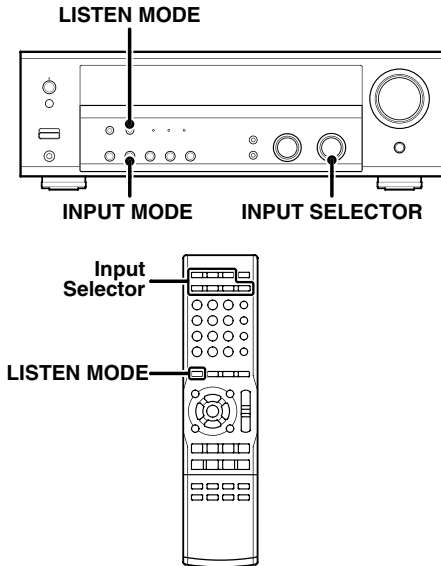

Preparations

- Turn ON related components.
- Complete "Preparing for surround sound" (speaker settings). → [16]
- Use the **INPUT SELECTOR** knob or **Input Selector** keys to select the component you wish to play back with surround sound.
- Use the **INPUT MODE** key to select the input mode (analog or digital) for the source you wish to playback. → [8]
- Noise will be produced when a DTS source is played by selecting the analog input.

1 Start playing the video software.

2 Press the LISTEN MODE key to select the listening mode.

The listening mode settings are stored separately for each input. If the input mode is set to full auto ("AUTO DETECT" lights), this model selects the optimal listening mode automatically based on the type of input signal and the speaker settings.

Each press of the LISTEN MODE key switches the setting as listed.

The listening mode settings are different depending on the type of input signal.

Dolby Digital Surround EX compliant disc :

Dolby Digital Surround EX compliant disc contains identification signals. When you choose **FULL AUTO** during "Input mode settings" (→ [8]), this amplifier detects the identification signals and change the Listen mode to the **DOLBY DIGITAL EX** (Dolby Digital Surround EX mode) automatically.

But sometimes we find some discs which are Dolby Digital Surround EX compliant disc but it does not contain the identification signals. If you find the notice like "Surround EX" on the label of disc or package, you can choose **DOLBY DIGITAL EX**, then you can enjoy Dolby Digital Surround EX sound.

When the Dolby Digital or Dolby Digital EX signal is input:

(The DOLBY DIGITAL or PRO LOGIC indicator lights up.)

- 1 **DOLBY DIGITAL** : Dolby Digital surround.
- 2 **DOLBY DIGITAL EX** : Dolby Digital EX surround.
(The DOLBY DIGITAL EX indicator lights up.)
- 3 **PL IIX MOVIE** : Pro Logic IIX surround MOVIE mode.
(The PRO LOGIC indicator lights up.)
- 4 **PL IIX MUSIC** : Pro Logic IIX surround MUSIC mode.
(The PRO LOGIC indicator lights up.)
- 5 **PL IIX GAME** : Pro Logic IIX surround GAME mode.
(The PRO LOGIC indicator lights up.)
- 6 **PL II MOVIE** : Pro Logic II surround MOVIE mode.
(The PRO LOGIC indicator lights up.)
- 7 **PL II MUSIC** : Pro Logic II surround MUSIC mode.
(The PRO LOGIC indicator lights up.)
- 8 **PL II GAME** : Pro Logic II surround GAME mode.
(The PRO LOGIC indicator lights up.)
- 9 **PRO LOGIC** : Pro Logic II surround PRO LOGIC mode.
(The PRO LOGIC indicator lights up.)
- 10 **STEREO** : Normal stereo playback.

When you select DOLBY DIGITAL

"DOLBY DIGITAL" will scroll from right to left.

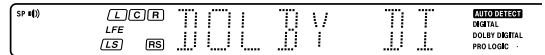

When the DTS or DTS-ES (matrix, discrete or bitstream) signal is input:

(The DTS LED indicator lights up.)

- 1 **DTS-ES MATRIX 6.1** : DTS - ES MATRIX 6.1 channel surround
(The DTS-ES and MATRIX 6.1 indicators light up.)
- 2 **DTS-ES DISCRETE 6.1** : DTS - ES DISCRETE 6.1 channel surround
(The DTS-ES and DISCRETE 6.1 indicators light up.)
- 3 **DTS** : DTS 5.1 channel surround
(The DTS indicator lights up.)
- 4 **DTS + NEO:6 CINEMA** : DTS + NEO:6 surround CINEMA mode.
(The DTS and NEO:6 indicators light up.)
- 5 **STEREO** : Normal stereo playback

When the analog signal or the digital signal (except for Dolby Digital or DTS signal) is input:

- 1 **PL IIX MOVIE** : Pro Logic IIX surround MOVIE mode.
(The PRO LOGIC indicator lights up.)
- 2 **PL IIX MUSIC** : Pro Logic IIX surround MUSIC mode.
(The PRO LOGIC indicator lights up.)
- 3 **PL IIX GAME** : Pro Logic IIX surround GAME mode.
(The PRO LOGIC indicator lights up.)
- 4 **PL II MOVIE** : Pro Logic II surround MOVIE mode.
(The PRO LOGIC indicator lights up.)
- 5 **PL II MUSIC** : Pro Logic II surround MUSIC mode.
(The PRO LOGIC indicator lights up.)
- 6 **PL II GAME** : Pro Logic II surround GAME mode.
(The PRO LOGIC indicator lights up.)
- 7 **PRO LOGIC** : Pro Logic II surround PRO LOGIC mode.
(The PRO LOGIC indicator lights up.)
- 8 **NEO:6 CINEMA** : NEO:6 surround CINEMA mode.
(The NEO:6 indicator lights up.)
- 9 **NEO:6 MUSIC** : NEO:6 surround MUSIC mode.
(The NEO:6 indicator lights up.)

Continued to next page

- ⑩ **ARENA** : DSP Surround ARENA mode.
- ⑪ **JAZZ CLUB** : DSP Surround JAZZ CLUB mode.
- ⑫ **THEATER** : DSP Surround THEATER mode.
- ⑬ **STADIUM** : DSP Surround STADIUM mode.
- ⑭ **DISCO** : DSP Surround DISCO mode.
- ⑮ **STEREO** : Normal stereo playback.

• Dolby Digital or DTS signal having more channels than the maximum number of playback channels available using this model's current settings is input, downmixing is performed to match the number of available channels.

3 Adjust the volume.

Notes

- Depending on the type of the signal or speaker setting, some listening modes cannot be selected.
- When playback is started, the sound may be cut or interrupted before the input source is confirmed as Dolby Digital.
- To enjoy Dolby Digital surround (as well as all the other listening modes) from a single component, be sure to use a Dolby Digital compatible source component.

DVD 6-channel playback

Using a DVD player or the like equipped with six (5.1) output channels and this model, you can enjoy surround sound playback. Connecting a DVD player which can decode the surround signal itself is also acceptable.

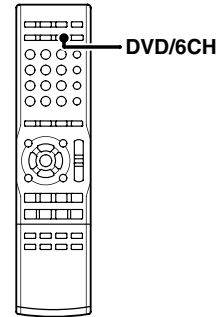
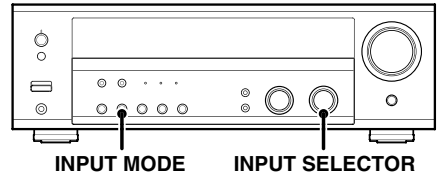

Preparations

- Connect your DVD player to the **DVD/6CH INPUT** jacks of this model.
- Turn on all other components that will be used.
- Complete "Preparing for surround sound". → 16

1 Select "DVD/6CH" as the input source.

2 Select "6CH INPT" by pressing the **INPUT MODE** key.

3 Start playback of the DVD software.

4 Adjust the volume.

- It is not possible to adjust the volume level or sound quality (**SETUP, SOUND, LISTEN MODE, ACTIVE EQ and TONE keys will not be functional**) of the channels separately when this model is in the 6CH INPUT mode. Adjust the volume with the controls of the DVD player.
For the powered subwoofer, you can adjust the volume of the subwoofer using the subwoofer's own volume control.

Convenient functions

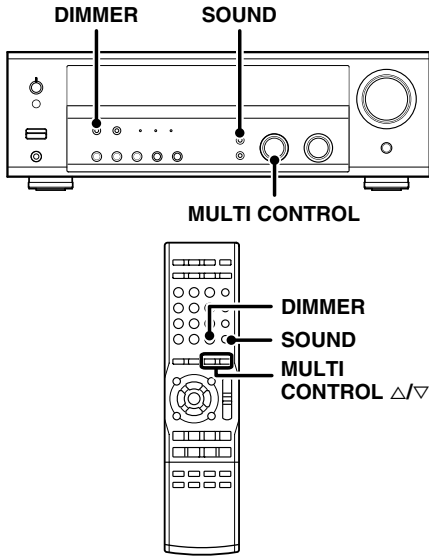

Adjusting the sound

You can make further adjustments to the sound while listening to playback in the surround mode.

- 1 Press the **SOUND** key until the desired item appears in the display.

Each time you press the button, the menu changes as follows:
Note that some items are not displayed depending on speaker settings and listening mode.

- 1 **C** (Center speaker level adjustment)*
- 2 **RS** (Surround Right speaker level adjustment)*
- 3 **RB** (Surround Back Right speaker level adjustment)*
- 4 **BS** (Surround Back speaker level adjustment)*
(KRF-V6100D only)
- 5 **LB** (Surround Back Left speaker level adjustment)*
- 6 **LS** (Surround Left speaker level adjustment)*
- 7 **SW** (Subwoofer level adjustment)*
- 8 **INPUT** (input level adjustment - analog mode only)
- 9 **NIGHT** (midnight mode ON/OFF - Dolby Digital and DTS mode only)
- 10 **PANORAMA** (panorama mode ON/OFF)**
- 11 **DIMENSION** (dimension adjustment)**
- 12 **CENTER WIDTH** (center width adjustment)**
- 13 **OFF**

* The adjustment is only temporary for the current input selection. The value will return automatically to the original setup value when the power is turned on/off or when the input selection is changed.

** Pro Logic IIx MUSIC mode and Pro Logic II MUSIC mode only.

(KRF-V6100D only)

- If you have selected "SPEAKER" as the Surround Back setting, "RB" and "LB" are not appeared but "BS" is appeared on the display.

- 2 Use the **MULTI CONTROL** knob or **MULTI CONTROL** Δ/∇ keys to adjust the setting as desired.

Midnight mode (Dolby Digital and DTS mode only)

When watching movies at night, you might not be able to raise the volume as loud as normal. Midnight mode compresses the dynamic range of previously specified heavy sound passage of the Dolby Digital and DTS mode sound track (like scenes with sudden increases in volume) to minimize the difference in volume between the scenes with heavy sound passage and scenes with normal sound passage. This makes it easy to hear all of the sound track, even when listening at low volumes.

- 1 Press the **SOUND** key repeatedly until "NIGHT" appears on the display.
 - This can be selected only if "CD/DVD", "DVD/6CH" or "VIDEO2" is selected as the source and the listen mode is set to "DOLBY DIGITAL" or "DTS".
- 2 Use the **MULTI CONTROL** knob or **MULTI CONTROL** Δ/∇ keys to select the **ON** or **OFF** setting.



- Some Dolby Digital or DTS software may not be compatible with the Midnight mode.

Panorama mode (Pro Logic IIx MUSIC mode and Pro Logic II MUSIC mode only)

When listening to music, you will be able to enjoy the "wraparound" sound effect when you adjust the panorama mode.

- 1 Press the **SOUND** key repeatedly until "PANORAMA" appears on the display.
 - The "PANORAMA" setting indication scrolls across the display. "PANORAMA" will be scrolled from right to left.



- 2 Use the **MULTI CONTROL** knob or **MULTI CONTROL** Δ/∇ keys to select the **ON** or **OFF** setting.
 - 1 **ON** : PANORAMA mode is ON.
 - 2 **OFF** : PANORAMA mode is OFF.



Dimension mode (Pro Logic IIx MUSIC mode and Pro Logic II MUSIC mode only)

When listening to music with certain recordings, you will also be able to achieve a suitable balance from all the speakers by adjusting the dimension mode.

- ❶ Press the **SOUND** key repeatedly until “DIMENSION” appears on the display.
 - The “DIMENSION” indication scrolls across the display.
- ❷ Use the **MULTI CONTROL** knob or **MULTI CONTROL** Δ/∇ keys to adjust the soundfield towards the rear or the front.

Soundfield is adjusted towards the front.

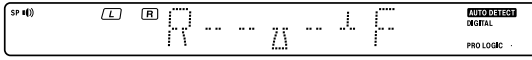

Soundfield is in neutral position.



Soundfield is adjusted towards the rear.

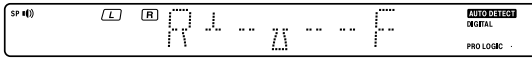

Center Width mode (Pro Logic IIx MUSIC mode and Pro Logic II MUSIC mode only)

Center Width adjustment allows you to enjoy an enhanced sound when listening to music through center image from only center speaker, or left and right speakers or various combinations adjustments.

- ❶ Press the **SOUND** key repeatedly until “CENTER WIDTH” appears on the display.
 - The “CENTER WIDTH” indication scrolls across the display.
 - When the center speaker is switched OFF, this mode will not be effective.
- ❷ Use the **MULTI CONTROL** knob or **MULTI CONTROL** Δ/∇ keys to adjust the left-center-right output.

Center image will be heard from Center speaker only.

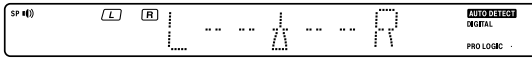

Center image will be heard from Left and Right speakers only.

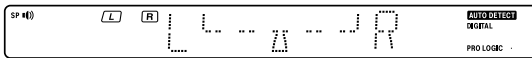

- When in other positions, center image from Center speaker, Left and Right speakers can be heard simultaneously with various combinations.

Display dimmer adjustment

The dimmer function lets you select the brightness of this model's display. You might find this useful if you darken your room to watch movies or listen to music.

If you want to use the remote control unit, press the **TUNER, MD/TAPE, VIDEO 1, VIDEO 2** or **AUX** key on the remote control unit to set it to the receiver control mode.

Each time you press the **DIMMER** key, the display brightness changes among the three available settings. Select the brightness level you find most pleasing.

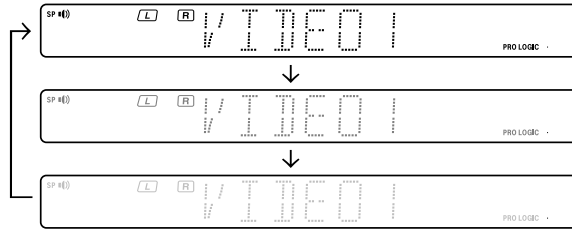

96kHz LPCM playback

This model is compatible with the 96kHz LPCM playback. To play a 96kHz DVD, set the listen mode to “STEREO”.

- In **F-AUTO** input mode, the listen mode will automatically be STEREO.
- When in **D-MANUAL** input mode (listen mode is not STEREO), “FS 96kHz” will appear in the display and no sound can be heard from the speakers. Press the **LISTEN MODE** key (the listen mode changes to the STEREO mode) to output sound from the speakers.

Basic remote control operations for KENWOOD DVD players

DVD player operation keys

The remote control of this unit can control KENWOOD DVD players directly without using the remote control supplied with the DVD player.

DV-4900, DV-4070B, DV-2070, DV-203, DVF-9010, DVF-K7010, DVF-5010, DVF-R9030, DVF-R7030, DVF-3530, DV-402, DV-5900, DV-5700, DVF-R9050, DVF-J6050, DV-505, DV-503, DV-502, DVF-3550, DVF-3050, DVF-R4050, DVF-605, DV-6050, DVF-R5060, DVF-3060, DVF-3060K, DV-705, DVF-R5070, DVF-3070, DVF-3080, DVF-N7080, DVF-8100, DVF-3200, DVF-3250 and DVF-3300.

How to operate the DVD player with the remote control

1. Press the **DVD** key to turn the DVD player on.
2. Press the **CD/DVD** key or **DVD/6CH** key to operate the functions of the DVD player.
3. Press each key for DVD player operation. Refer to the operation manual of the DVD players for the detailed operating instructions.
(To return to the receiver operation mode, press other **Input Selector** key.)

DVD player operation keys

You can perform these basic operations using the keys described below when connected to KENWOOD DVD player.

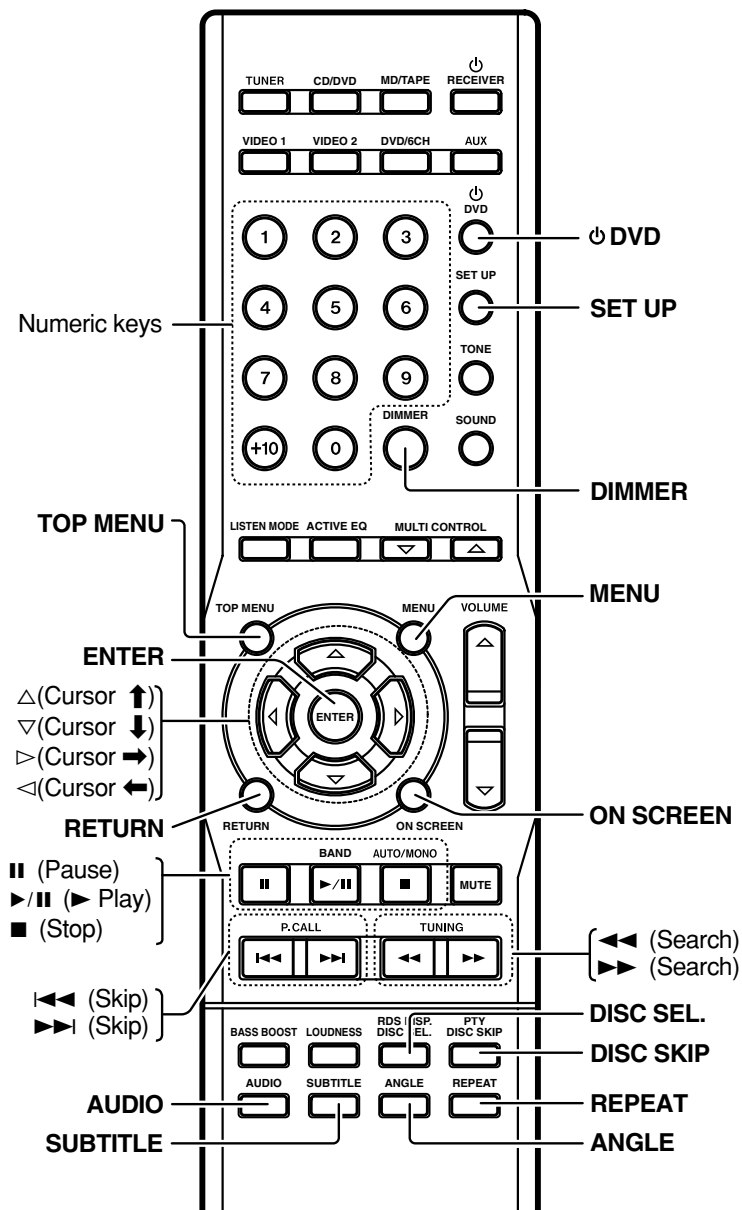

In case of difficulty

Resetting the Microcomputer

The microcomputer may malfunction (unit cannot be operated, or shows an erroneous display) if the power cord is unplugged while the power is ON, or due to some other external factor. If this happens, execute the following procedure to reset the microcomputer and return the unit to its normal operating condition.

With the power cord plugged in, turn the POWER ON/OFF key OFF. Then, while holding down the ON/STANDBY  key, press the POWER ON/OFF key.

- Please note that resetting the microcomputer will clear the contents of the memory and return the unit to the state it was in when it left the factory.



Amplifier

| Symptom | Cause | Remedy |
|--|---|--|
| No sound from the speakers. | <ul style="list-style-type: none"> • The speaker cords are disconnected. • VOLUME is set to the minimum position. • MUTE is ON. • The SPEAKERS switches are set to OFF. | <ul style="list-style-type: none"> • Connect it properly referring to "Connecting the speakers". → 14 • Adjust the volume to a proper level. • Turn OFF the MUTE. → 20 • Set the SPEAKERS switch to ON. → 19 |
| The standby indicator blinks and sound is not output. | <ul style="list-style-type: none"> • Speaker cords are short-circuited. | <ul style="list-style-type: none"> • Turn the power off, eliminate the short-circuiting, then turn on the power again. |
| Sound is not output from one of the speakers. | <ul style="list-style-type: none"> • The speaker cord is disconnected. • The speaker is not set up correctly. | <ul style="list-style-type: none"> • Connect it properly referring to "Connecting the speakers". → 14 • Set it up properly referring to "Speaker settings". → 16 |
| Sound is not output from the surround speakers and/or the center speaker, or their sound is very soft. | <ul style="list-style-type: none"> • The surround speaker cords and/or the center speaker cord is disconnected. • The speaker is not set up correctly. • A surround mode has not been activated. • The surround and/or center volume controls are set to the minimum level. | <ul style="list-style-type: none"> • Connect it properly referring to "Connecting the speakers". → 14 • Set it up properly referring to "Speaker settings". → 16 • Select a surround mode. • Adjust the speaker levels using the test tone. → 17 |
| When playing a Dolby Digital source signal using a DVD player, the sound is cut off soon after it starts. | <ul style="list-style-type: none"> • There are many possible causes for this problem, depending on the type of DVD player used. | <ul style="list-style-type: none"> • Set the input mode to digital manual before starting playback of the Dolby Digital source. → 8 |
| No sound is produced during playback from a DVD player. | <ul style="list-style-type: none"> • The input mode is set to digital manual. | <ul style="list-style-type: none"> • Press the INPUT MODE key to select to full auto mode. → 8 |
| A video source cannot be recorded normally. | <ul style="list-style-type: none"> • The software is copy-guarded. | <ul style="list-style-type: none"> • Copy-guarded video software cannot be recorded. |

Tuner

| Symptom | Cause | Remedy |
|---|--|---|
| Radio stations cannot be received. | <ul style="list-style-type: none"> • No antenna is connected. • The broadcast band is not set properly. • The frequency of the desired station is not tuned. | <ul style="list-style-type: none"> • Connect an antenna. → 15 • Set the broadcast band properly. • Tune the frequency of the desired station. → 22 |
| Interference. | <ul style="list-style-type: none"> • Noise due to ignition of an automobile. • Noise due to interference from an electric appliance. • Noise due to a nearby TV set. | <ul style="list-style-type: none"> • Install the outdoor antenna away from the road. • Turn off the power to the appliance. • Install this model farther away from the TV. |
| A station which was preset cannot be received by pressing the corresponding numeric key. | <ul style="list-style-type: none"> • The preset station belongs to a frequency that cannot be received. • The preset memory was cleared because the power cord had been unplugged for a long period of time. | <ul style="list-style-type: none"> • Preset a station with a receivable frequency. • Preset the station again. |

Remote control unit

| Symptom | Cause | Remedy |
|--|---|--|
| Remote control operation is not possible. | <ul style="list-style-type: none">• The remote control is set to the DVD player operation mode.• Batteries are exhausted.• The remote control unit is too far away from the main system, controlling angle is too large, or there is an obstacle between this model and the remote.• The remote control has not been changed to the operation mode for the KENWOOD DVD player you wish to control. | <ul style="list-style-type: none">• Press any of the Input Selector keys to select the appropriate operation mode.• Replace with new batteries.• Operate the remote control unit within the controllable range. →  4• Press the CD/DVD or DVD/6CH key to activate the operation mode for the component you want to control before operation. →  32 |

Maintenance of the unit

When the front panel or case becomes dirty, wipe with a soft, dry cloth. Do not use thinner, benzine, alcohol, etc. for these agents may cause discoloration.

In regard to contact cleaner

Do not use contact cleaners because it could cause a malfunction. Be specially careful not to use contact cleaners containing oil, for they may deform the plastic component.

AUDIO section

| | |
|---|---------------------------------|
| Rated power output during STEREO operation DIN/IEC (63 Hz ~ 12.5 kHz, 0.7% T.H.D., at 6 Ω) | 100 W + 100 W |
| Effective power output during STEREO operation RMS(1 kHz, 10% T.H.D., at 6 Ω) | 120 W + 120 W |
| Effective power output during SURROUND operation | |
| FRONT | |
| (1 kHz, 0.7 % T.H.D. at 6 Ω one channel driven) ... | 100 W + 100 W |
| (1 kHz, 10 % T.H.D. at 6 Ω one channel driven) | 120 W + 120 W |
| CENTER | |
| (1 kHz, 0.7 % T.H.D. at 6 Ω one channel driven) | 100 W |
| (1 kHz, 10 % T.H.D. at 6 Ω one channel driven) | 120 W |
| SURROUND | |
| (1 kHz, 0.7 % T.H.D. at 6 Ω one channel driven) ... | 100 W + 100 W |
| (1 kHz, 10 % T.H.D. at 6 Ω one channel driven) | 120 W + 120 W |
| SURROUND BACK (KRF-V6100D) | |
| (1 kHz, 0.7 % T.H.D. at 6 Ω one channel driven) | 100 W |
| (1 kHz, 10 % T.H.D. at 6 Ω one channel driven) | 120 W |
| Total harmonic distortion | 0.05 % (1 kHz, 50 W, 6 Ω) |
| Frequency response (IHF'66) | |
| CD/DVD | 20 Hz ~ 70 kHz, +0 dB ~ -3.0 dB |
| Signal to noise ratio (IHF'66) | |
| CD/DVD | 95 dB |
| Input sensitivity / impedance | |
| CD/DVD, AUX, MD/TAPE, VIDEO 1, VIDEO 2 | 550 mV / 47 kΩ |
| DVD/6CH INPUT | 550 mV / 15 kΩ |
| Output level / impedance | |
| MD/TAPE REC | 550 mV / 1 kΩ |
| PRE OUT (SUBWOOFER) | 1.5 V / 2.2 kΩ |
| PRE OUT (SURROUND BACK) | 1.5 V / 2.2 kΩ |
| Tone control | |
| BASS | ±10 dB (at 100 Hz) |
| TREBLE | ±10 dB (at 10 kHz) |
| Loudness control | |
| VOLUME at -30 dB level | +8 dB (100 Hz) |

DIGITAL AUDIO section

| | |
|---------------------------------------|------------------------------------|
| Sampling frequency | 32 kHz, 44.1 kHz, 48 kHz, 96 kHz |
| Input level / impedance / wave length | |
| Optical | (-15 dBm ~ -21 dBm), 660 nm ±30 nm |
| Coaxial | 0.5 Vp-p / 75 Ω |

VIDEO section

| | |
|---|-------------------|
| VIDEO inputs / outputs | |
| VIDEO (composite) | 1 Vp-p / 75 Ω |
| S-VIDEO inputs / outputs (KRF-V6100D) | |
| S-VIDEO (luminance signal) | 1 Vp-p / 75 Ω |
| S-VIDEO (chrominance signal) | 0.286 Vp-p / 75 Ω |
| COMPONENT VIDEO inputs / outputs (KRF-V6100D) | |
| COMPONENT VIDEO (luminance signal) | 1 Vp-p / 75 Ω |
| COMPONENT VIDEO (CB/CR-signal) | 0.7 Vp-p / 75 Ω |

FM tuner section

| | |
|---|--|
| Tuning frequency range | 87.5 MHz ~ 108.0 MHz |
| Usable sensitivity (DIN at 75 Ω) | |
| MONO | 1.3 μV / 13.2 dBf (40 kHz DEV., S/N 26 dB) |
| STEREO | 45 μV / 42.1 dBf (46 kHz DEV., S/N 46 dB) |
| Total harmonic distortion (DIN at 1 kHz) | |
| MONO | 0.2% (71.2 dBf input) |
| STEREO | 0.8% (71.2 dBf input) |
| Signal to noise ratio (DIN weighted at 1 kHz) | |
| MONO | 65 dB (40 kHz DEV., 71.2 dBf input) |
| STEREO | 60 dB (46 kHz DEV., 71.2 dBf input) |
| Stereo separation (DIN 1 kHz) | 36 dB |
| Selectivity (±300 kHz) | 64 dB |
| Frequency response (30 Hz ~ 15 kHz) | +0.5 dB, -3.0 dB |

AM tuner section

| | |
|--|---------------------------|
| Tuning frequency range | 531 kHz ~ 1,602 kHz |
| Usable sensitivity (30% mod., S/N 20 dB) | 16 μV / (600 μV/m) |
| Signal to noise ratio (30% mod., 1 mV input) | |
| | 50 dB (60 dBμV EMF input) |

GENERAL

| | |
|---------------------------|-----------------------|
| Power consumption | 280 W |
| Standby Power consumption | less than 0.9 W |
| AC outlet | |
| SWITCHED | 2 (total 90 W max.) |
| Dimensions | |
| | W: 440 mm (17-5/16") |
| | H: 143 mm (5-5/8") |
| | D: 303 mm (11-15/16") |
| Weight (Net) | 7.8 kg (17.2 lb) |

Notes

1. KENWOOD follows a policy of continuous advancements in development. For this reason specifications may be changed without notice.
2. The full performance may not be exhibited in an extremely cold location (under a water-freezing temperature).

AUDIO section

Rated power output during STEREO operation

100 watts per channel minimum RMS, both channels driven, at 8 from 40 Hz to 20 kHz with no more than 0.7% total harmonic distortion. (FTC)

DIN/IEC (63 kHz ~ 12.5kHz, 0.7% T.H.D., at 8 Ω)
..... 100 W + 100 W

Effective power output during STEREO operation

RMS (1 kHz, 10 % T.H.D. at 8 Ω) 120 W + 120 W

Effective power output during SURROUND operation

FRONT

(1 kHz, 0.7% T.H.D. at 8Ω one channel driven) 100 W + 100 W

(1 kHz, 10% T.H.D. at 8Ω one channel driven) 120 W + 120 W

CENTER

(1 kHz, 0.7% T.H.D. at 8Ω one channel driven) 100 W

(1 kHz, 10% T.H.D. at 8Ω one channel driven) 120 W

SURROUND

(1 kHz, 0.7% T.H.D. at 8Ω one channel driven) 100 W + 100 W

(1 kHz, 10% T.H.D. at 8Ω one channel driven) 120 W + 120 W

SURROUND BACK (KRF-V6100D)

(1 kHz, 0.7 % T.H.D. at 8 Ω one channel driven) 100 W

(1 kHz, 10 % T.H.D. at 8 Ω one channel driven) 120 W

Total harmonic distortion 0.05% (1 kHz, 50 W, 8Ω)

Frequency response (IHF'66)

CD/DVD 20 Hz ~ 70 kHz, +0 dB, -3.0 dB

Signal to noise ratio (IHF'66)

CD/DVD 95 dB

Input sensitivity / impedance

CD/DVD, AUX, MD/TAPE, VIDEO 1, VIDEO 2 550 mV / 47 kΩ

DVD/6CH INPUT 550 mV / 15 kΩ

Output level / impedance

MD TAPE REC 550 mV / 1 kΩ

PRE OUT (SUBWOOFER) 1.5 V / 2.2 kΩ

PRE OUT (SURROUND BACK) 1.5 V / 2.2 kΩ

Tone control

BASS ±10 dB (at 100 Hz)

TREBLE ±10 dB (at 10 kHz)

Loudness control

VOLUME at -30dB level +8 dB (at 100 Hz)

DIGITAL AUDIO section

Sampling frequency 32 kHz, 44.1 kHz, 48 kHz, 96 kHz

Input level / impedance / wave length

Optical (-15 dBm ~ -21 dBm), 660 nm ±30 nm

Coaxial 0.5 Vp-p / 75 Ω

VIDEO section

VIDEO inputs / outputs

VIDEO (composite) 1 Vp-p / 75 Ω

S-VIDEO inputs / outputs (KRF-V6100D)

S-VIDEO (luminance signal) 1 Vp-p / 75 Ω

S-VIDEO (chrominance signal) 0.286 Vp-p / 75 Ω

COMPONENT VIDEO inputs/outputs (KRF-V6100D)

COMPONENT VIDEO (luminance signal) 1 Vp-p/75 Ω

COMPONENT VIDEO (CB/CR-signal) 0.7 Vp-p/75 Ω

FM tuner section

Tuning frequency range 87.5 MHz ~ 108.0 MHz

Usable sensitivity (MONO)

..... 1.6 μV (75 Ω) / 15.2 dBf (75 kHz DEV., SINAD 30 dB)

50dB quieting sensitivity

STEREO 28 μV (75 Ω) / 40.2 dBf

Total harmonic distortion (1 kHz)

MONO 0.5% (71.2 dBf input)

STEREO 0.7% (71.2 dBf input)

Signal to noise ratio (1 kHz, 75 kHz DEV.)

MONO 75 dB (71.2 dBf input)

STEREO 68 dB (71.2 dBf input)

Stereo separation (1 kHz) 40 dB

Selectivity (±400 kHz) 50 dB

Frequency response (30 Hz ~ 15kHz), +0.5 dB, -3.0 dB

AM tuner section

Tuning frequency range 531 kHz ~ 1,602 kHz

Usable sensitivity (30% mod., S/N 20dB) 16 μV / (600 μV/m)

Signal to noise ratio (30% mod., 1 mV input)

..... 50 dB (60 dBμV EMF input)

GENERAL

Power consumption 280W

Standby Power consumption less than 1.3 W

AC outlet

SWITCHED 1 (total 90 W max.)

Dimensions W : 440 mm (17-5/16")

H : 143 mm (5-5/8")

D : 303 mm (11-15/16")

Weight (Net) 7.8 kg (17.2 lb)

Notes

1. KENWOOD follows a policy of continuous advancements in development. For this reason specifications may be changed without notice.
2. The full performance may not be exhibited in an extremely cold location (under a water-freezing temperature).

KENWOOD

For your records

Record the serial number, found on the back of the unit, in the spaces designated on the warranty card, and in the space provided below. Refer to the model and serial numbers whenever you call upon your dealer for information or service on this product.

Model _____

Serial Number _____