

KENWOOD

KCA-BT200

Bluetooth UNIT

INSTRUCTION MANUAL

APPAREIL Bluetooth

MODE D'EMPLOI

UNIDAD Bluetooth

MANUAL DE INSTRUCCIONES

Kenwood Corporation



Take the time to read through this instruction manual.

Familiarity with installation and operation procedures will help you obtain the best performance from your new Bluetooth unit.

For your records

Record the serial number, found on the back of the unit, in the spaces designated on the warranty card, and in the space provided below. Refer to the model and serial numbers whenever you call upon your Kenwood dealer for information or service on the product.

Model KCA-BT200 Serial number _____

US Residence Only

Register Online

Register your Kenwood product at
www.Kenwoodusa.com

Contents

| | | | |
|--|-----------|--|-----------|
| Before use | 3 | Remote control | 17 |
| Basic Operation of hands-free phoning (Model-A) | 4 | Making a call | |
| Before Use | | Receiving a call | |
| Making a call | | Call waiting | |
| Receiving a call | | During a call | |
| Call waiting | | Bluetooth Audio | 17 |
| During a call | | Before Use | |
| Other functions | | Playing Bluetooth Audio | |
| Basic Operation of hands-free phoning (Model-B) | 6 | Operation of hands-free phoning (Model-E) | 18 |
| Before Use | | Before Use | |
| Making a call | | Hands-Free Control screen | |
| Receiving a call | | Remote Controller | |
| Call waiting | | Key Operation | |
| During a call | | Making a call | |
| Other functions | | Receiving a call | |
| Basic Operation of hands-free phoning (Model-C) | 8 | During a call | |
| Before Use | | Other functions | |
| Making a call | | Appendix | 22 |
| Receiving a call | | Accessories/ Installation Procedure | 24 |
| Call waiting | | Connection | 25 |
| During a call | | Installation | 25 |
| Other functions | | Troubleshooting Guide | 26 |
| Basic Operation of hands-free phoning (Model-D) | 10 | Specifications | 27 |
| Before Use | | | |
| Making a call | | | |
| Receiving a call | | | |
| During a call | | | |
| Other functions | | | |
| Function Operation | 12 | | |
| Registering Bluetooth device | | | |
| Registering Special Bluetooth device | | | |
| Registering PIN Code | | | |
| Downloading the Phone Book | | | |
| Selecting the Bluetooth device You Wish to Connect | | | |
| Deleting a Registered Bluetooth device | | | |
| Displaying the Firmware Version | | | |
| Adding a voice dialing command | | | |
| Setting a Voice Command for Category | | | |
| Downloading the SMS | | | |
| SMS (Short Message Service) | | | |

The Bluetooth word mark and logos are owned by the Bluetooth SIG, Inc. and any use of such marks by Kenwood Corporation is under license. Other trademarks and trade names are those of their respective owners.

Before use

▲WARNING

To prevent injury or fire, take the following precautions:

- To prevent a short circuit, never put or leave any metallic objects (such as coins or metal tools) inside the unit.
- Mounting and wiring this product requires skills and experience. For safety's sake, leave the mounting and wiring work to professionals.

▲CAUTION

To prevent damage to the machine, take the following precautions:

- Do not install the unit in a spot exposed to direct sunlight or excessive heat or humidity. Also avoid places with too much dust or the possibility of water splashing.

Notes

- If you experience problems during installation, consult your Kenwood dealer.
- The capital letters and small letters of the display can be reversed.
- The illustrations of the display and the panel appearing in this manual are examples used to explain more clearly how the controls are used. Therefore, what appears on the display in the illustrations may differ from what appears on the display on the actual equipment, and some of the illustrations on the display may be inapplicable.

Kenwood Receivers available for this unit

Operation methods are classified into groups by receiver (control unit) type.

First, refer to the model list in <Appendix> (page 22) to confirm the group of the operation you wish to perform.

Model-A, Model-B, Model-C, or Model-D

Refer to the relevant pages (<Basic Operation of hands-free phoning>). To use a Bluetooth audio player with this unit, refer to <Bluetooth Audio> (page 17).

Model-E

Refer to the relevant pages (<Operation of hands-free phoning>). To use a Bluetooth audio player with this unit, refer to <Bluetooth Audio> (page 17).

Model-F

After performing the operation mentioned on page 12, refer to the Instruction Manual for Control Unit. To use a Bluetooth audio player with this unit, refer to <Bluetooth Audio> (page 17).

Notes on selecting and deleting a Hands-Free Phone

- If a cell-phone is already selected, deselect it, and then select a different one.
- "BT200 FW****" and the firmware version are displayed in the cell-phone selection list. Although the same contents are displayed in the deletion list, they cannot be deleted.
- The audio player is displayed on the device list after the registration. However, the audio player on the list cannot be selected.

Model-G

Refer to the Instruction Manual for Control Unit.

About the Cell-Phone

This unit conforms to the following Bluetooth specifications:

| | |
|----------------|--|
| Version | Bluetooth Standard Ver. 1.2 |
| Profile | HFP (Hands Free Profile) OPP (Object Push Profile) PBAP (Phonebook Access Profile) SYNC (Synchronization Profile) |

For the cell-phones verified for compatibility, access the following URL:

<http://www.kenwood.com/bt/information/>



- The units supporting the Bluetooth function have been certified for conformity with the Bluetooth Standard following the procedure prescribed by Bluetooth SIG. However, it may be impossible for such units to communicate with your cell-phone depending on its type.
- HFP is a profile used to make a hands-free call.
- OPP is a profile used to transfer data such as a phone book between units.

About the Bluetooth Audio player

This unit conforms to the following Bluetooth specifications:

| | |
|----------------|--|
| Version | Bluetooth Standard Ver. 1.2 |
| Profile | A2DP (Advanced Audio Distribution Profile) AVRCP (Audio/Video Remote Control Profile) |



- A2DP is a profile designed to transfer the music from an audio player.
- AVRCP is a profile designed to control playback and selection of music by an Audio player.

Basic Operation of hands-free phoning (Model-A)

Before Use

- You need to register your cell-phone before using it with this unit. For more details, see <Registering Bluetooth device> (page 12).
- If you have registered two or more cell-phones, you need to select one of them. For more details, see <Selecting the Bluetooth device You Wish to Connect> (page 14).
- To use the Phone Book, it must be downloaded to this unit in advance. For details, see <Downloading the Phone Book> (page 13).
- For the method of operation in the Menu mode, refer to the Instruction Manual for Control Unit.
- For more information regarding the function with  mark, see <Function note> (page 23).

Making a call

Dialing Method

1. Select dialing method item during Menu mode

Select the "DIALING MODE"/ "D.MODE" display.

2. Select a dialing method

Press the  button.

• "NUMBER DIAL" » "PHONE BOOK1" » "PHONE BOOK2" » "OUT-CALL" » "IN-CALL" » "MISSED CALLS"

• "N-DIAL" » "PH-BOOK1" » "PH-BOOK2" » "OUT-CALL" » "IN-CALL" » "MIS-CALL"

► Methods of operations in the above modes are described below.

3. Exit the dialing method selection mode

Exit Menu mode.

► Dial a number

2-1. Select the "NUMBER DIAL"/ "N-DIAL" display.

2-2. Enter a phone number

Press the number ([1] – [0]), #([FM]), *([AM]), or +() button on the remote controller.

2-3. Make a call

Press the [DIRECT] button on the remote controller.

 You can input max 32 digits.

► Speed dialing (Preset dial)

2-1. Select the "NUMBER DIAL"/ "N-DIAL" display.

2-2. Select the preset dial number

Press the [1] – [6] button.

2-3. Make a call

Press the  button for at least 1 second.

 You need to register the preset dial number. (page 5)

► Calling a number in the call log

2-1. Select the "OUT-CALL" (outgoing call), "IN-CALL" (incoming call), or "MISSED CALLS"/"MIS-CALL" (missed call) display.

2-2. Select a name or phone number

Push the Control knob towards up or down.

2-3. Make a call

Press the  button for at least 1 second.

► Calling a number in the Phone Book

2-1. Select the "PHONE BOOK1"/"PH-BOOK1" display, proceed to step 2-2.

Select the "PHONE BOOK2"/"PH-BOOK2" display, proceed to step 2-3.

2-2. Select the initial to be searched for

| Operation type | Operation |
|--------------------------------|---|
| Move to the next character. | Push the Control knob towards right or left. |
| Move to the next row. | Push the Control knob towards up or down. |
| Determine the selected initial | Press the  button for at least 1 second. |

2-3. Select the name

| Operation type | Operation |
|---------------------|--|
| Change the name. | Push the Control knob towards up or down. |
| Change the initial. | Push the Control knob towards right or left. |

2-4. Make a call

Press the  button for at least 1 second.

Make a voice dialing call

1. Select voice recognize item during Menu mode

Select the "VOICE RECOG"/ "V-RECOG" display.

2. Press the  button for at least 1 second.

"V-RECOG READY"/ "VR READY" is displayed.

3. Press the  button.

"PB NAME" is displayed.



When a beep is heard, utter the name within 2 seconds.

4. "PB TYPE"/ "PN type" is displayed.

When a beep is heard, utter the category within 2 seconds.

5. Make a call

This step is the same as step 3 of the procedure in <Calling a number in the Phone Book>. You can make a call or select a category.

 If your voice cannot be recognized, a message is displayed. Pressing the  button allows you to retry voice input. (page 26)

 Both the name and category requires registration of a voice tag. (page 15)

 Audio sound is not output during voice recognize.

Display of phone number type (category)

| Display | Description | Display | Description |
|-----------------|-------------|----------------|-------------|
| "GE"/ "GENERAL" | General | "OF"/ "OFFICE" | Office |
| "HM"/ "HOME" | Home | "OT"/ "OTHER" | Other |
| "MO"/ "MOBILE" | Mobile | | |

Receiving a call

Answering a Phone Call

Model-A-1: Press the Control knob or one of [1] – [6] buttons

Model-A-2: Press the [VOL] button or one of [1] – [6] buttons

☞ Inserting a disc such as a CD will disconnect your call.

Rejecting an Incoming Call

Press the [SRC] button.

Call waiting

Answering Another Incoming Call with the Current Call Suspended

- Model A-1: Press the Control knob.
Model A-2: Press the [VOL] knob.
- Push the Control knob towards up or down. Select the "ANSWER" display.
- Model A-1: Press the Control knob.
Model A-2: Press the [VOL] knob.

Answering another Incoming Call after Terminating the Current Call

Press the [SRC] button.

Continuing the Current Call

- Model A-1: Press the Control knob.
Model A-2: Press the [VOL] knob.
- Push the Control knob towards up or down. Select the "REJECT" display.
- Model A-1: Press the Control knob.
Model A-2: Press the [VOL] knob.

Answering the Waiting Call after Terminating the Current Call

Press the [AUTO]/ [TI] button for at least 1 second.

Switching between the Current Call and Waiting Call

Model A-1: Press the Control knob.

Model A-2: Press the [VOL] knob.

During a call

Disconnecting a Call

Press the [SRC] button.

Switching to the Private Mode

Press the  button.

Switches between Private talk ("PV TALK") or Hands-free talk ("HF TALK") when pressed.

Adjusting the Voice Volume during a Call

Model A-1: Turn the Control knob.

Model A-2: Turn the [VOL] knob.

Other functions

Clearing the Disconnection Message

Press the [AUTO]/ [TI] button for at least 1 second.

Switching between Display Modes

Press the [AUTO]/ [TI] button. You can switch between the Phone Book and the Call List.

Registering to the Preset Dial Number List

- Enter the phone number you wish to register**
Enter the phone number with reference to the following:
Dial a number/ Calling a number in the call log/
Calling a number in the Phone Book
- Select the button you wish to register**
Press the [1] – [6] button for at least 2 seconds.
- Exit the dialing method selection mode**
Press the [MENU] button.

Items Set in Menu mode

* To enter the Menu mode, press the Control knob for at least 1 second.

| Display | Setting overview |
|------------------------------|--|
| "DVC REGIST"*/ "DVC REG"* | Register a Bluetooth device (pairing). Refer to page 12. |
| "S-DVC SELECT"*/ "SDVC SEL"* | Allow registration of a special device that cannot be registered normally. Refer to page 12. |
| "PHONE SEL"*/ "PHN-SEL"* | Select a cell-phone subject to hands-free connection. Refer to page 14. |
| "DIALING MODE"*/ "D.MODE"* | Select a dialing method. Refer to page 4. |
| "AUDIO SEL"*/ "AUD-SEL"* | Select the audio player to be connected. Refer to page 14. |
| "SMS DOWNLOAD"*/ "SMS DL"* | Download a short message. Refer to page 16. |
| "SMS INBOX"*/ "INBOX"* | Display the received short message. Refer to page 16. |
| "VOICE TAG"*/ "VOICETAG"* | Register the voice tag for "voice recognize". Refer to page 15. |
| "VOICE RECOG"*/ "V-RECOG"* | Make a voice dialing call. Refer to page 4. |
| "DEVICE DEL"*/ "DVC-DEL"* | Cancel registration of the Bluetooth device. Refer to page 14. |
| "DVC-STATUS"*/ "D-STATUS" | "HF-CONNECT"/ "AD-CONNECT"/ "BAT"/ "SGNL": Display the status of the Bluetooth device. Refer to page 22. |
| "PIN EDIT"* | Specify the PIN code required when registering this unit using the Bluetooth device. Refer to page 12. |
| "AUTO ANS"*/ "ANS" | "OFF"/ "0" – "99": Answer a call automatically after lapse of the preset time interval for automatic answer. Refer to page 22. |
| "SP SEL"*/ "SPK" | "FRT"/ "F-R"/ "F-L": Specify the voice output speaker. Refer to page 22. |
| "CALL BEEP"/ "C-BP" | "ON"/ "OFF": Output a beep from the speaker when a call comes in. Refer to page 22. |

Basic Operation of hands-free phoning (Model-B)

Before Use

- You need to register your cell-phone before using it with this unit. For more details, see <Registering Bluetooth device> (page 12).
- If you have registered two or more cell-phones, you need to select one of them. For more details, see <Selecting the Bluetooth device You Wish to Connect> (page 14).
- To use the Phone Book, it must be downloaded to this unit in advance. For details, see <Downloading the Phone Book> (page 13).
- For the method of operation in the Function control, refer to the Instruction Manual for Control Unit.
- For more information regarding the function with  mark, see <Function note> (page 23).

Making a call

Dialing Method

1. Entry dialing method mode

Press the [ATT] button for at least 1 second.

2. Select a dialing method

Press the Control knob ()

"DIAL" » "INITIAL" » "P-BOOK" » "OUT-CALL" » "IN-CALL" » "MIS-CALL"

► Methods of operations in the above modes are described below.

3. Exit the dialing method selection mode

Press the [ATT] button for at least 1 second.

► Dial a number ()

2-1. Select the "DIAL" display.

2-2. Enter a phone number

Press the number ([1] – [0]), #([FM]), *([AM]), or +([▶▶]) button on the remote controller.

2-3. Make a call

Press the [DIRECT] button on the remote controller.

 You can input max 32 digits.

► Speed dialing (Preset dial)

2-1. Select the "DIAL" display.

2-2. Select the preset dial number

Model B-1:

Press the [1] – [6] button.

Model B-2:

2-1. Press the [FNC] button.

2-2. Select the number to recall by turning the Control knob.

2-3. Press the Control knob.

2-3. Make a call

Press the Control knob () for at least 1 second.

 You need to register the preset dial number. (page 7)

► Calling a number in the call log ()

2-1. Select the "OUT-CALL" (outgoing call), "IN-CALL" (incoming call), or "MIS-CALL" (messed call) display.

2-2. Select a name or phone number

Push the Control knob towards up or down.

2-3. Make a call

Press the Control knob () for at least 1 second.

► Calling a number in the Phone Book ()

2-1. Select the "INITIAL" display, proceed to step 2-2.

Select the "P-BOOK" display, proceed to step 2-3.

2-2. Select the initial to be searched for

| Operation type | Operation |
|--------------------------------|--|
| Move to the next character. | Push the Control knob towards right or left. |
| Move to the next row. | Push the Control knob towards up or down. |
| Determine the selected initial | Press the Control knob () |

2-3. Select the name

| Operation type | Operation |
|---------------------|--|
| Change the name. | Push the Control knob towards up or down. |
| Change the initial. | Push the Control knob towards right or left. |

2-4. Make a call

Press the Control knob () for at least 1 second.

Make a voice dialing call

1. Select voice recognize item during Function control

Select "BT" > "V-REC".

2. Press the Control knob ()

"PB Name?" is displayed.



When a beep is heard, utter the name within 2 seconds.

3. "PN Type?" is displayed.

When a beep is heard, utter the category within 2 seconds.

4. Make a call





This step is the same as step 3 of the procedure in <Calling a number in the Phone Book>. You can make a call or select a category.

 If your voice cannot be recognized, a message is displayed. Pressing the  button allows you to retry voice input. (page 26)

 Both the name and category requires registration of a voice tag. (page 15)

 Audio sound is not output during voice recognize.

Display of phone number type (category)

| Display | Description | Display | Description |
|--|-------------|---|-------------|
| "General"/  | General | "Office"/  | Office |
| "Home"/  | Home | "Other"/  | Other |
| "Mobile"/  | Mobile | | |

Receiving a call

Answering a Phone Call

Press the [AUD] button or one of [1] – [6] buttons.

☞ Inserting a disc such as a CD will disconnect your call.

Rejecting an Incoming Call

Press the [ATT] button for at least 1 second.

Call waiting

Answering Another Incoming Call with the Current Call Suspended

1. Press the [AUD] button.
2. Push the Control knob towards up or down. Select the "ANSWER" display.
3. Press the [AUD] button.

Answering another Incoming Call after Terminating the Current Call

Press the [SRC] button.

Continuing the Current Call

1. Press the [AUD] button.
2. Push the Control knob towards up or down. Select the "REJECT" display.
3. Press the [AUD] button.

Answering the Waiting Call after Terminating the Current Call

Press the [ATT] button for at least 1 second.

Switching between the Current Call and Waiting Call

Press the [AUD] button.

During a call

Disconnecting a Call

Press the [SRC] button.

Switching to the Private Mode (🗨️)

Press the Control knob (▶️||).

Switches between Private talk ("PRVT") or Hands-free talk when pressed.

Adjusting the Voice Volume during a Call

Turn the [AUD] knob.

Other functions

Clearing the Disconnection Message

Press the [ATT] button for at least 1 second.

Switching between Display Modes

Press the [AUTO]/ [TI] button. You can switch between the Phone Book and the Call List.

Registering to the Preset Dial Number List

1. Enter the phone number you wish to register
Enter the phone number with reference to the following:

Dial a number/ Calling a number in the call log/
Calling a number in the Phone Book

2. Select the button you wish to register

Model B-1:

Press the [1] – [6] button for at least 2 seconds.

Model B-2:

2-1. Press the [FNC] button.

2-2. Select the number to memory by turning the Control knob.

2-3. Press the Control knob for at least 1 second.

3. Exit the dialing method selection mode

Press the [ATT] button for at least 1 second.

Items Set in Function control

* To enter the Menu mode, press the Control knob for at least 1 second.

| Item | Setting overview |
|-------------------|--|
| MENU | "Device Regist"* Register a Bluetooth device (pairing). Refer to page 12. |
| | "SPCL DVC Select"* Allow registration of a special device that cannot be registered normally. Refer to page 12. |
| | "Phone Selection"* Select a cell-phone subject to hands-free connection. Refer to page 14. |
| | "Audio Selection"* Select the audio player to be connected. Refer to page 14. |
| | "Device Delete"* Cancel registration of the Bluetooth device. Refer to page 14. |
| | "BT DVC Status"* Display the status of the Bluetooth device. |
| | "PIN Code Edit"* Specify the PIN code required when registering this unit using the Bluetooth device. Refer to page 12. |
| | "Auto Answer"* "OFF" / "0s" – "99s": Answer a call automatically after lapse of the preset time interval for automatic answer. Refer to page 22. |
| | "SP Select"* "Front" / "F-R" / "F-L": Specify the voice output speaker. Refer to page 22. |
| | "Call Beep"* "ON" / "OFF": Output a beep from the speaker when a call comes in. Refer to page 22. |
| | "BT F/W Update"* Display the firmware version and update the firmware. Refer to page 12. |
| BT > V-REC | Make a voice dialing call |
| BT > VOICE > NAME | Register a name tag for voice recognition. Refer to page 15. |
| BT > VOICE > TYPE | Register a type (category) voice tag for voice recognition. Refer to page 15. |
| BT > SMS > SMSDL | Download a short message. Refer to page 16. |
| BT > SMS > INBOX | Display the received short message. Refer to page 16. |

Basic Operation of hands-free phoning (Model-C)

Before Use

- You need to register your cell-phone before using it with this unit. For more details, see <Registering Bluetooth device> (page 12).
- If you have registered two or more cell-phones, you need to select one of them. For more details, see <Selecting the Bluetooth device You Wish to Connect> (page 14).
- To use the Phone Book, it must be downloaded to this unit in advance. For details, see <Downloading the Phone Book> (page 13).
- For the method of operation in the Menu mode, refer to the Instruction Manual for Control Unit.
- For more information regarding the function with [☎] mark, see <Function note> (page 23).

Making a call

Dialing Method

1. Entry dialing method mode

Press the [ATT] button for at least 1 second.

2. Select a dialing method

Press the [▶||] button.

"N-Dial" » "PH-Book1" » "PH-Book2" » "Out-Call" » "In-Call" » "MIS-Call"

▶ Methods of operations in the above modes are described below.

3. Exit the dialing method selection mode

Press the [ATT] button for at least 1 second.

▶ Dial a number (☎)

2-1. Select the "N-Dial" display.

2-2. Enter a phone number

Press the number ([1] – [0]), #([FM]), *([AM]), or +([▶▶]) button on the remote controller.

2-3. Make a call

Press the [DIRECT] button on the remote controller.

☎ You can input max 32 digits.

▶ Speed dialing (Preset dial)

2-1. Select the "N-Dial" display.

2-2. Select the preset dial number

Press the [1] – [6] button.

2-3. Make a call

Press the [▶||] button for at least 1 second.

☎ You need to register the preset dial number. (page 9)

▶ Calling a number in the call log (☎)

2-1. Select the "Out-Call" (outgoing call), "In-Call" (incoming call), or "MIS-Call" (missed call) display.

2-2. Select a name or phone number

Push the Control knob towards up or down.

2-3. Make a call

Press the [▶||] button for at least 1 second.

▶ Calling a number in the Phone Book (☎)

2-1. Select the "PH-Book1" display, proceed to step 2-2.

Select the "PH-Book2" display, proceed to step 2-3.

2-2. Select the initial to be searched for

| Operation type | Operation |
|--------------------------------|---|
| Move to the next character. | Push the Control knob towards right or left. |
| Move to the next row. | Push the Control knob towards up or down. |
| Determine the selected initial | Press the [▶] button for at least 1 second. |

2-3. Select the name

| Operation type | Operation |
|---------------------|--|
| Change the name. | Push the Control knob towards up or down. |
| Change the initial. | Push the Control knob towards right or left. |

2-4. Make a call

Press the [▶||] button for at least 1 second.

Make a voice dialing call

1. Select voice recognize item during Menu mode

Select the "V-RECOG" display.

2. Press the [▶||] button for at least 1 second.

"VR Ready" is displayed.

3. Press the [▶||] button.

"PB NAME?" is displayed.

When a beep is heard, utter the name within 2 seconds.

4. "PB TYPE?" is displayed.

When a beep is heard, utter the category within 2 seconds.

5. Make a call

This step is the same as step 3 of the procedure in <Calling a number in the Phone Book>. You can make a call or select a category.

☎ If your voice cannot be recognized, a message is displayed. Pressing the [▶||] button allows you to retry voice input. (page 26)

☎ Both the name and category requires registration of a voice tag. (page 15)

☎ Audio sound is not output during voice recognize.

Display of phone number type (category)

| Display | Description | Display | Description |
|-----------------|-------------|----------------|-------------|
| "GE"/ "GENERAL" | General | "OF"/ "OFFICE" | Office |
| "HM"/ "HOME" | Home | "OT"/ "OTHER" | Other |
| "MO"/ "MOBILE" | Mobile | | |

Receiving a call

Answering a Phone Call

Press the Control knob or one of [1] – [6] buttons.
☞ Inserting a disc such as a CD will disconnect your call.

Rejecting an Incoming Call

Press the [SRC] button.

Call waiting

Answering Another Incoming Call with the Current Call Suspended

1. Press the Control knob.
2. Push the Control knob towards up or down. Select the "ANSWER" display.
3. Press the Control knob.

Answering another Incoming Call after Terminating the Current Call

Press the [SRC] button.

Continuing the Current Call

1. Press the Control knob.
2. Push the Control knob towards up or down. Select the "REJECT" display.
3. Press the Control knob for at least 1 second.

Answering the Waiting Call after Terminating the Current Call

Press the [ATT] button for at least 1 second.

Switching between the Current Call and Waiting Call

Press the Control knob.

During a call

Disconnecting a Call

Press the [SRC] button.

Switching to the Private Mode (📞)

Press the [▶||] button.

Switches between Private talk ("PV TALK") or Hands-free talk ("HF TALK") when pressed.

Adjusting the Voice Volume during a Call

Turn the Control knob.

Other functions

Clearing the Disconnection Message

Press the [ATT] button for at least 1 second.

Switching between Display Modes

Press the [SE] button. You can switch between the Phone Book and the Call List.

Registering to the Preset Dial Number List

1. **Enter the phone number you wish to register**
Enter the phone number with reference to the following:
Dial a number/ Calling a number in the call log/
Calling a number in the Phone Book
2. **Select the button you wish to register**
Press the [1] – [6] button for at least 2 seconds.
3. **Exit the dialing method selection mode**
Press the [ATT] button for at least 1 second.

Items Set in Menu mode

* To enter the Menu mode, press the Control knob for at least 1 second.

| Display | Setting overview |
|--------------|--|
| "DVC REG"* | Register a Bluetooth device (pairing). Refer to page 12. |
| "SDVC SEL"* | Allow registration of a special device that cannot be registered normally. Refer to page 12. |
| "PHN-SEL"* | Select a cell-phone subject to hands-free connection. Refer to page 14. |
| "AUD-SEL"* | Select the audio player to be connected. Refer to page 14. |
| "SMS DL"* | Download a short message. Refer to page 16. |
| "IN BOX"* | Display the received short message. Refer to page 16. |
| "VOICE TAG"* | Register the voice tag for "voice recognize". Refer to page 15. |
| "V-RECOG"* | Make a voice dialing call. Refer to page 8. |
| "DVC-DEL"* | Cancel registration of the Bluetooth device. Refer to page 14. |
| "D-STATUS" | "HF-CON"/ "AD-CON"/ "BAT"/ "SGNL": Display the status of the Bluetooth device. Refer to page 22. |
| "PIN EDIT"* | Specify the PIN code required when registering this unit using the Bluetooth device. Refer to page 12. |
| "ANS" | "OFF"/ "0" – "99": Answer a call automatically after lapse of the preset time interval for automatic answer. Refer to page 22. |
| "SPK" | "FRT"/ "F-R"/ "F-L": Specify the voice output speaker. Refer to page 22. |
| "C-BP" | "ON"/ "OFF": Output a beep from the speaker when a call comes in. Refer to page 22. |

Basic Operation of hands-free phoning (Model-D)

Before Use

- You need to register your cell-phone before using it with this unit. For more details, see <Registering Bluetooth device> (page 12).
- If you have registered two or more cell-phones, you need to select one of them. For more details, see <Selecting the Bluetooth device You Wish to Connect> (page 14).
- To use the Phone Book, it must be downloaded to this unit in advance. For details, see <Downloading the Phone Book> (page 13).
- For the method of operation in the Menu mode, refer to the Instruction Manual for Control Unit.
- For more information regarding the function with  mark, see <Function note> (page 23).

Making a call

Dialing Method

1. Entry dialing method mode

Model-D-1, 2, 3:

Press the [ATT] button for at least 1 second.

Model-D-4:

Select "D.MODE" in Menu mode.

2. Select a dialing method

Model-D-1, 4:

Press the Control knob () button).

"N-DIAL" » "PH-BOOK1" » "PH-BOOK2" » "OUT-CALL" » "IN-CALL"

Model-D-2:

Press the Control knob () button).

"DIAL" » "INITIAL" » "PHONE BOOK"/"PH.BOOK" » "OUT-CALL" » "IN-CALL"

Model-D-3:

2-1-1. Press the [NEXT] button.

2-1-2. Press the [1] ("DIAL"), [2] ("PHBK"), [3] ("OUT-C"), or [4] ("IN-C") button.

Pressing the [2] ("PHBK") button switches between the Phone Book search methods.

- Methods of operations in the above modes are described below.

3. Exit the dialing method selection mode

Model-D-1, 2, 3:

Press the [ATT] button for at least 1 second.

Model-D-4:

Exit Menu mode.

► Dial a number ()

2-1. Select the "N-DIAL"/"DIAL" display.

2-2. Enter a phone number

Press the number ([1] – [0]), #([FM]), *([AM]), or +([▶▶]) button on the remote controller.

2-3. Make a call

- Press the [DIRECT] button on the remote controller.
- ☞ You can input max 32 digits.

► Speed dialing (Preset dial)

2-1. Select the "N-DIAL"/"DIAL" display.

2-2. Select the preset dial number

Model-D-1, 4:

Press the [1] – [6] button.

Model-D-2:

2-2-1. Press the [FNC] button.

2-2-2. Select the number to recall by turning the Control knob.

2-2-3. Press the Control knob.

Model-D-3:

2-2-1. Press the [NEXT] button.

2-2-2. Press the [1] ("1") – [6] ("6") button.

2-3. Make a call

Press the Control knob () button for at least 1 second.

- ☞ You need to register the preset dial number. (page 11)

► Calling a number in the call log ()

2-1. Select the "OUT-CALL"/"OUT-C" (outgoing call) or "IN-CALL"/"IN-C" (incoming call) display.

2-2. Select a name or phone number

Push the Control knob towards up or down.

2-3. Make a call

Press the Control knob () button for at least 1 second.

► Calling a number in the Phone Book ()

2-1. Select the "PH-BOOK1"/"INITIAL" display, proceed to step 2-2.

Select the "PH-BOOK2"/"PHONE BOOK"/"PH.BOOK" display, proceed to step 2-3.

2-2. Select the initial to be searched for

| Operation type | Operation |
|--------------------------------|--|
| Move to the next character. | Push the Control knob towards right or left. |
| Move to the next row. | Push the Control knob towards up or down. |
| Determine the selected initial | Press the Control knob () button for at least 1 second. |

2-3. Select the name

| Operation type | Operation |
|---------------------|--|
| Change the name. | Push the Control knob towards up or down. |
| Change the initial. | Push the Control knob towards right or left. |

2-4. Make a call

Press the Control knob () button for at least 1 second.

Receiving a call

Answering a Phone Call

Model-D-1, 2, 3:

Press the [AUDIO] button or one of [1] – [6] buttons.

Model-D-4:

Press the [VOL] button or one of [1] – [6] buttons.

☞ Inserting a disc such as a CD will disconnect your call.

Rejecting an Incoming Call

Model-D-1, 2, 3:

Press the [ATT] button for at least 1 second.

Model-D-4:

Press the [SRC] button.

During a call

Disconnecting a Call

Press the [SRC] button.

Switching to the Private Mode (🗉)

Press the Control knob ([▶||] button).

Switches between Private talk ("PV TALK"/ "PRIVATE")

or Hands-free talk ("HF TALK"/ —) when pressed.

Adjusting the Voice Volume during a Call

Turn the [VOL] knob.

Other functions

Clearing the Disconnection Message

Model-D-1, 2, 3:

Press the [ATT] button for at least 1 second.

Model-D-4:

Press the [AUTO]/ [TI] button for at least 1 second.

Switching between Display Modes

You can switch between the Phone Book and the Call List.

Model-D-1, 2, 4:

Press the [DISP]/ [AUTO]/ [TI] button. (If the [DISP] button is not provided, press the [AUTO] or [TI] button.)

Model-D-3:

Press the [AUTO]/ [TI] button.

Registering to the Preset Dial Number List

1. Enter the phone number you wish to register

Enter the phone number with reference to the following:

Dial a number/ Calling a number in the call log/

Calling a number in the Phone Book

2. Select the button you wish to register

Model-D-1, 4:

Press the [1] – [6] button for at least 2 seconds.

Model-D-2:

2-1. Press the [FNC] button.

2-2. Select the number to memory by turning the Control knob.

2-3. Press the Control knob.

Model-D-3:

2-1. Press the [NEXT] button.

2-2. Press the [1] ("1") – [6] ("6") button for at least 2 seconds.

3. Exit the dialing method selection mode

Model-D-1, 2, 3:

Press the [ATT] button for at least 1 second.

Model-D-4:

Press the [MENU] button.

Items Set in Menu mode

* To enter the Menu mode, press the Control knob for at least 1 second.

*1 To enter the Menu mode, push the Control knob towards right or left.

| Display | Setting overview |
|-----------------------------------|--|
| "PHN-SEL"*/ "Phone Selection"* | Select a cell-phone subject to hands-free connection. Refer to page 14. |
| "PHN-DEL"*/ "Phone Delete"* | Cancel registration of the Bluetooth device. Refer to page 14. |
| "D.MODE"* | Model-D-4: Select a dialing method. Refer to page 10. |
| "P-STATUS"*/ "Phone Status"*1 | "BT-CON"/ "BAT"/ "SGNL": Display the status of the Bluetooth device. Refer to page 22. |
| "ANS"/ "Auto Answer" | "OFF"/ "0" – "99": Answer a call automatically after lapse of the preset time interval for automatic answer. Refer to page 22. |
| "SPK"/ "SP Select" | "FRT" ("Front")/ "F-R"/ "F-L": Specify the voice output speaker. Refer to page 22. |
| "C-BP"/ "Call Beep" | "ON"/ "OFF": Output a beep from the speaker when a call comes in. Refer to page 22. |

Function Operation

Registering Bluetooth device

To make your Bluetooth device (cell-phone or audio player) usable with this unit, you need to register it (pairing). You can register up to five Bluetooth devices to this unit.

When registering from Bluetooth devices

- 1 Turn on the control unit.
- 2 Start registering a unit by operating the Bluetooth device.

By operating the Bluetooth device, register the hands-free unit or audio player (pairing). Select "KCA-BT200" from the list of connected units.

- 3 Enter a PIN code

Model-A, B, C:

Input the PIN code registered as mentioned in <Registering PIN Code> (page 13).

Model-D, E, F:

Enter "0000" as a PIN code.

Check that registration is complete on the Bluetooth device.

- 4 By operating the Bluetooth device, start hands-free or audio connection.

When registering from this unit (Function of Model-A/ Model-B/ Model-C)

- 1 Select the Bluetooth Device registration mode

Select the "Device Regist"/ "DVS REGIST"/ "DVS REG"/ "DVC REG" display.

- 2 Press the [▶II] button (Control knob) for at least 1 second.

Search for the Bluetooth device.

When search is completed, "Finished" is displayed.

- 3 Select the Bluetooth Device

Push the Control knob upward or downward to select the Bluetooth device.

Press the [▶II] button (Control knob) to determine the selection.

- 4 Input the PIN code

| Operation type | Operation |
|-------------------------|---|
| Select the numbers. | Push the Control knob towards up or down. |
| Move to the next digit. | Push the Control knob towards left. |
| Delete the last digit. | Push the Control knob towards right. |

- 5 Transmit the PIN code

Press the Control knob for at least 1 second.

If "Pairing Success"/"PAIRING OK"/"PAIR OK" is displayed, registration is completed.

6 Return to the device list

Model-A, C:

Press the [▶II] button (Control knob).

Model-B:

Press the [FNC] button.

7 End device registration

Exit Menu mode.



- You can also register from the Bluetooth device side. For the PIN code necessary for registration, see <Registering PIN Code> (page 12).
- This unit allows up to eight digits to be input for a PIN code. If a PIN code cannot be input from this unit, it can be input from the Bluetooth device.
- If there are 5 or more Bluetooth devices registered, you cannot register a new Bluetooth device.
- If the error message appears even though the PIN code is correct, try <Registering Special Bluetooth device> (page 12).
- For how to operate the Bluetooth device, refer to the Instruction Manual that comes with your Bluetooth device.

Function of Model-A/ Model-B/ Model-C

Registering Special Bluetooth device

Allow registration of a special device that cannot be registered normally (pairing).

- 1 Select the special device registration mode

Select the "SPCL DVC Select"/"S-DVC SELECT"/ "SDVC SEL" display.

- 2 Model-A, B:

Press the [▶II] button (Control knob) for at least 1 second.

Model-C:

Press the Control knob for at least 1 second.

- 3 Select a device name

Push the Control knob upward or downward to select a device name.

Press the [▶II] button (Control knob) to determine the selection.

If "Completed"/"Complete" is displayed, registration of the special device is completed.

- 4 Go through the procedure of <Registering Bluetooth device> (page 12) and complete the registration (pairing).



- If the device name is not in the list, select "Other Phone".

Function of Model-A/ Model-B/ Model-C

Registering PIN Code

By operating the Bluetooth device, specify the PIN code necessary for registering this unit.

1 Select the PIN code edit mod

Select the "PIN Code Edit"/ "PIN EDIT" display.

2 Model-A, B:

Press the [▶II] button (Control knob) for at least 1 second.

Model-C:

Press the Control knob for at least 1 second.

3 Input the PIN code

| Operation type | Operation |
|-------------------------|---|
| Select the numbers. | Push the Control knob towards up or down. |
| Move to the next digit. | Push the Control knob towards left. |
| Delete the last digit. | Push the Control knob towards right. |

4 Register a PIN code

Model-A, B:

Press the [▶II] button (Control knob) for at least 1 second.

Model-C:

Press the Control knob for at least 1 second.

If "Completed"/"Complete" is displayed, registration is completed.



- By default, "0000" is specified.
- A PIN code can be specified with up to eight digits.

Downloading the Phone Book

Download the phone book data from the cell-phone to this unit so that you can use the Phone Book of this unit.

To download automatically

If the cell-phone supports a phone book synchronization function, the phone book is downloaded automatically after Bluetooth connection.

- ☞ Setting on the cell-phone may be required.
- ☞ If no phone book data is found in the unit even after the complete display, your cell-phone may not support automatic download of phone book data. In this case, try downloading manually.

To download from the cell-phone manually

1 By operating the cell-phone, end the hands-free connection.

2 By operating the cell-phone, send the phone book data to this unit

By operating the cell-phone, download the phone book data to this unit.

During downloading:

"Downloading", "DOWNLOAD", or "Now Downloading..." is displayed.

After completion of downloading (Model-A, B, C, D):

"Completed" or "COMPLETE" is displayed.

3 By operating the cell-phone, start the hands-free connection.

To clear the downloading completion

message (Model-A, B, C, D):

Press any button.



- For how to operate the cell-phone, refer to the Instruction Manual that comes with your cell-phone.
- Up to 1000 phone numbers can be registered for each registered cell-phone.
- Up to 32 digits can be registered for each phone number along with up to 50* characters representing a name. (* 50: Number of alphabetic alphabetical characters. Fewer characters can be input depending on the type of characters.)
- To cancel downloading of the phone book data, operate the cell-phone.

Function Operation

Function of Model-A/ Model-B/ Model-C/ Model-D
In Standby mode

Selecting the Bluetooth device You Wish to Connect

When two or more Bluetooth devices have already been registered, you need to select the Bluetooth device you wish to use.

1 Select the Bluetooth device selection mode during Menu mode

Cell-phone

Select the "Phone Selection"/ "PHONE SEL"/ "PHN-SEL" display.

Audio player (excluding Model-D)

Select the "Audio Selection"/ "AUD-SEL" display.

2 Enter the selected Bluetooth device selection mode

Model-A, B, D:

Press the [▶II] button (Control knob) for at least 1 second.

Model-C:

Press the Control knob for at least 1 second. '(name)' is displayed.

3 Select the Bluetooth device

Push the Control knob towards up or down.

4 Set up the Bluetooth device

Push the Control knob towards right or left.

*'(name)' or '-(name)' is displayed.

'(dark color) or "(": The selected cell-phone is busy.

*'(light color) or " _": The selected cell-phone is on standby.

" (blank): The cell-phone is deselected.

☞ If a cell-phone is already selected, deselect it, and then select a different one.

5 Exit the Bluetooth device selection mode

Exit Menu mode.



- For Model-A, C, and D, the firmware version "BT200 FW ***" is displayed at the end of the Bluetooth device list. For how to update the firmware, access our website. <http://www.kenwood.com/bt/information/>
- For Model-D, the audio player is displayed on the device list after the registration. However, the audio player on the list cannot be selected.

Function of Model-A/ Model-B/ Model-C/ Model-D
In Standby mode

Deleting a Registered Bluetooth device

You can delete a registered Bluetooth device.

1 Select the Bluetooth device deletion mode during Menu mode

Select the "Device Delete"/ "DEVICE DEL"/ "Phone Delete"/ "PHN-DEL" display.

2 Enter the Bluetooth device deletion mode

Model-A, B, D:

Press the [▶II] button (Control knob) for at least 1 second.

Model-C:

Press the Control knob for at least 1 second. '(name)' is displayed.

3 Select the Bluetooth device you wish to delete

Push the Control knob towards up or down.

4 Delete the selected Bluetooth device

Model-A, C, D-1, D-3:

Press the [▶II] button (Control knob) for at least 1 second.

Model-B, D-2:

4-1. Press the Control knob.

4-2. Select "YES" using the Control knob.

4-3. Press the Control knob.

5 Exit the Bluetooth device deletion mode

Exit Menu mode.



- When a registered cell-phone is deleted, its Phone Book, log, SMS, and voice tag are also deleted.
- For Model-A, C, and D: The firmware version "BT200 FW ***" is displayed and cannot be deleted.

Function of Model-B

Displaying the Firmware Version

Display the version of the firmware of this unit.

1 Select the Bluetooth Firmware update item during Menu mode

Select the "BT F/W Update" display.

2 Enter the Bluetooth Firmware update mode

Press the Control knob ([▶II]) for at least 1 second.

The firmware version appears.

3 Exit the Bluetooth Firmware update mode Exit Menu mode.



- For how to update the firmware, access our website.
<http://www.kenwood.com/bt/information/>

Function of Model-A/ Model-B/ Model-C

Adding a voice dialing command

Add a voice tag to the phonebook for voice dialing.
You can register up to 35 voice tags.

1 Entry the voice tag mode

Select the "NAME MEM"/ "PB Name Edit"/ "Name EDT" display.

Model-A, C: Press the [▶II] button for at least 1 second.

Model-B: Press the [▶II] button (Control knob).

2 Search for the name to register

Select the name to register with reference to 2-3 in <Calling a number in the PhoneBook>.

If a voice tag has already been registered for a name, "*" is displayed before the name.

3 Select a mode

Model-A-1: Turn the Control knob.

Model-A-2, C: Push the Control knob towards up or down.

Model-B: Push the Control knob towards right or left.

| Display | Operation |
|-------------------------------|-----------------------|
| "N-REG"/"REGIST"/"Name REG" | Register a voice tag. |
| "N-CHK"/"PLAY"/"Name CHK" * | Play a voice tag. |
| "N-DEL"/"DELETE"/"Name DEL" * | Delete a voice tag. |
| "RETURN" | Return to step 2. |

* Displayed only when a name for which a voice tag has been registered is selected.

Select "N-REG"/"REGIST"/"Name REG"

* Audio sound is not output during voice tag registration.

4 Register a voice tag (first)

Press the [▶II] button (Control knob).

"Enter Voice 1"/ "ENTER1" is displayed.

When a beep is heard, utter a voice tag within 2 seconds.

5 Confirm the voice tag (second)

Press the [▶II] button (Control knob).

"Enter Voice 2"/ "ENTER2" is displayed.

When a beep is heard, utter the same voice tag as

that you uttered in step 4 within 2 seconds.
"COMPLETE" is displayed.

6 End registration

Model-A, B: Press the [▶II] button (Control knob).

Model-C: Press the [▶II] button.

Return to step 2. You can register another voice tag continuously.

- ✳ If your voice cannot be recognized, a message is displayed. Pressing the [▶II] button allows you to retry voice input. (page 26)

Select "N-CHK"/"PLAY"/"Name CHK"

4 Press the [▶II] button (Control knob).

Play the registered voice and return to step 2.

Select "N-DEL"/"DELETE"/"Name DEL"

4 Delete a voice tag

Model-A, C:

Press the [▶II] button for at least 1 second.

Model-B:

4-1. Press the Control knob.

4-2. Select "YES" using the Control knob.

4-3. Press the Control knob.

Return to step 2.

Exit the voice tag mode

Exit Menu mode.

Function of Model-A/ Model-B/ Model-C

Setting a Voice Command for Category

Add a voice tag to the phone number category (type) for voice calling.

1 Entry the voice tag mode

Model-A: Press the [▶II] button for at least 1 second.

Model-C: Push the Control knob towards up or down.

Select the "TYPE MEM"/ "PN Type Edit"/ "Type EDT" display.

Model-A, C: Press the [▶II] button for at least 1 second.

Model-B: Press the [▶II] button (Control knob).

2 Select the category (type) you wish to set

Push the Control knob towards up or down.

Press the [▶II] button (Control knob).

Next page ▶

Function Operation

3 Select a mode.

Model-A-1: Turn the Control knob.

Model-A-2, C: Push the Control knob towards up or down.

Model-B: Push the Control knob towards right or left.

| Display | Operation |
|-------------------------------|-----------------------|
| "T-REG"/"REGIST"/"Type REG" | Register a voice tag. |
| "T-CHK"/"PLAY"/"Type CHK" * | Play a voice tag. |
| "T-DEL"/"DELETE"/"Type DEL" * | Delete a voice tag. |
| "RETURN" | Return to step 2. |

* Displayed only when a category (type) for which a voice tag has been registered is selected.

4 Register the category (type) by performing steps 4 to 6 in <Adding a voice dialing command> (page 15).

Exit the voice tag mode

Exit Menu mode.

Function of Model-A/ Model-B/ Model-C

Downloading the SMS

Download the short message (SMS) arrived at the cell-phone so that it can be read on this unit.

1 Select the SMS download item during Menu mode

Select the "SMS Download"/ "SMS DL" display.

2 Start downloading

Model-A, B:

Press the [▶II] button (Control knob) for at least 1 second.

Model-C:

Press the Control knob for at least 1 second.

"SMS Downloading"/ "DOWNLOAD" is displayed. When the downloading finishes, "Completed"/ "COMPLETE" is displayed.

3 Exit the SMS download mode

Exit Menu mode.



- The cell-phone must be able to transmit the SMS using Bluetooth. Setting on the cell-phone may be required. If the cell-phone does not support SMS function, the SMS download item in Menu mode is not displayed.
- When the SMS is downloaded from the cell-phone, the unopened messages in the cell-phone are opened.

Function of Model-A/ Model-B/ Model-C

SMS (Short Message Service)

The SMS arrived at the cell-phone is displayed on the receiver.

A newly arrived message is displayed.



- To prevent car accidents, the driver should not read the SMS while driving.

When a new message arrives

"SMS Received"/"NEW SMS" is displayed.

The display disappears with any operations.

Displaying the SMS

1 Select the SMS Inbox mode during Menu mode

Select the "SMS Inbox"/ "INBOX"/ "SMS" display.

2 Entry the SMS Inbox mode

Model-A, B:

Press the [▶II] button (Control knob) for at least 1 second.

Model-C:

Press the Control knob for at least 1 second.

A message list appears.

3 Select a message

Push the Control knob towards up or down.

- Select a phone number and reception date display mode.
Model-A: Press the [AUTO]/ [TI] button.
Model-C: Press the [SE] button for at least 1 second.
- Scroll the messages.
Push the Control knob towards right or left.
Keep pressing the Control knob scrolls the messages.

4 Display the text

Press the [▶II] button (Control knob).

Pressing this button again allows you to select a message again.

5 Exit the SMS Inbox mode

Exit Menu mode.



- The unopened message is displayed at the beginning of the list. Other messages are displayed in the order of reception.
- The SMS that has arrived when the cell-phone is not linked with Bluetooth cannot be displayed. Download the SMS.

Remote control

Making a call

Enters the dialing method selection mode
[()] button

Selects a dialing method [▶|II] button

Number dial input

| Operation type | Operation |
|----------------------------------|-------------------|
| Inputs a digit. | [0] – [9] buttons |
| Inputs "+". | [▶ ▶] button |
| Inputs "#". | [FM] button |
| Inputs "*". | [AM] button |
| Clears the entered phone number. | [◀◀] button |

 You can input max 32 digits.

Makes a call [DIRECT] button

Receiving a call

Answers the call [()] button

Switches between the private talk mode and the hands-free talk mode [▶|II] button

Call waiting (Function of Model-A, B, C)

Answering Another Incoming Call with the Current Call Suspended [()] button

Answering another Incoming Call after Terminating the Current Call [SRC] button

Continuing the Current Call [1] button

During a call

End the call [SRC] button

Adjusts the voice volume [VOL] buttons



- If your remote controller has a mode selection switch, set it to "AUD".
- Remote controllers with the [()] button and/or numeric buttons are available optionally. Purchase a remote controller with a desired function.

Bluetooth Audio

Before Use

- You need to register your Bluetooth Audio player before using it with this unit. For more details, see <Registering Bluetooth device> (page 12).
- The Model-A, Model-B, or Model-C allows you to select the Bluetooth audio player you wish to connect. Refer to <Selecting the Bluetooth device You Wish to Connect> (page 14).
- For Model-D, Model-E, or Model-F, operate the Bluetooth Audio player for connection.
- For the Model-G, refer to the Instruction Manual for Control Unit.

Function of Model-A/ Model-B/ Model-C/ Model-D/ Model-E/ Model-F

Playing Bluetooth Audio

Source select

Model-A, B, C, D:

Press the [SRC] button.

Select the "BT Audio EXT"/ "BT-A EXT"/ "EXT Media"/ "*MEDIA" display.

Model-E, F:

To select the source, select "EXT Media" with reference to the Instruction Manual for Control Unit.

Pause and play

Model-A, B, C, D: Press the [▶|II] button (Control knob).

Model-E, F: Press the [▶|II] button.

Music Search

Model-A, B, C, D: Push the Control knob towards right or left.

Model-E, F: Press the [◀◀|] or [▶|▶|] button.





- All or some of the operations above cannot be performed if the Bluetooth audio player is not ready for remote control.
- The information about the music played by the Bluetooth audio player cannot be displayed. Either Bluetooth audio player cannot be displayed, or "T-" is displayed.
- Switching between Bluetooth audio sources does not start or stop playback automatically. Perform the operation for starting or stopping playback.
- Some audio players cannot be controlled remotely or reconnected after Bluetooth disconnection. Operate the main unit of the audio player to connect Bluetooth.
- For Model-E and F: The buttons other than needed for operation above may be appeared. However they are invalid.

Operation of hands-free phoning (Model-E)

Before Use

- You need to register your cell-phone before using it with this unit. For more details, see <Registering Bluetooth device> (page 12).
- If you have registered two or more cell-phones, you need to select one of them. For more details, see <Selecting a Hands-Free Phone> (page 21).
- To use the Phone Book, it must be downloaded to this unit in advance. For details, see <Downloading the Phone Book> (page 13).

- 3 Displays the Incoming Calls screen.
(See the <Calling a number in the call log>, page 20)
- 4 Switches between the private and hands-free modes (only when a call in progress).
- 5 Displays the Hands-Free Set Up screen.
(See the <Setting up the Hands-Free Phone>, page 20)
- 6 Enter three phone numbers for quick dialing.
(See the <Speed dialing>, page 20)
- 7 Enters a phone number.
(See the <Dial a number>, page 20)
- 8 Displays the signal strength.*
The more the number of bar segments, the stronger the signal.
- 9 Displays the present Auto Answering status
When Auto Answering is on: 
When Auto Answering is off: 
- 10 Displays the battery drain of the cell-phone.*
The more the number of bar segments, the higher the battery level.
- 11 Starts the call.
- 12 Ends the call.
Clears the phone number being entered.
- 13 Clears the entered phone number.
- 14 Returns to the previous screen.
- 15 Displays the calling and called phone numbers.
If you have registered a phone number in the Phone Book, the destination person name is displayed.
- 16 Displays the status of connection with the cell-phone.
White: The cell-phone is connected.
Orange: The cell-phone is not connected, or it is outside the service range.

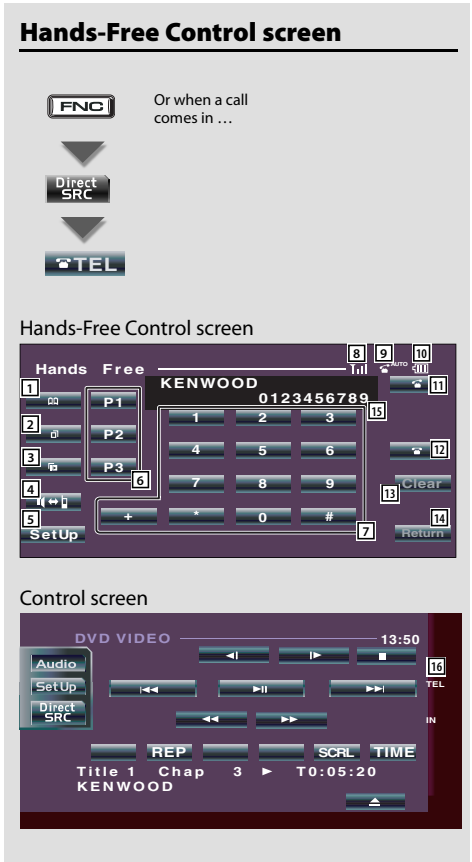

- 1 Displays the Search for Phone Book screen.
(See the <Calling a number in the Phone Book>, page 20)
- 2 Displays the Out Going Calls screen.
(See the <Calling a number in the call log>, page 20)

- While your car is moving, some functions are disabled for safety's sake. The buttons associated with the disabled functions become ineffective if pressed.
- When the Hands-Free Control screen appears, the name of the connected cell-phone is displayed for 5 seconds.
- Setting the cell-phone in the private mode can disable the hands-free function.
- * Since the number of steps of the control unit is different from that of the cell-phone, the statuses displayed on the control unit may discord from those displayed on the cell-phone. No status

is displayed if information about it cannot be obtained.

- Increasing the volume excessively is more likely to produce echo. If echo is produced, turn down the volume as low as possible. Echo increases in proportion to the volume.

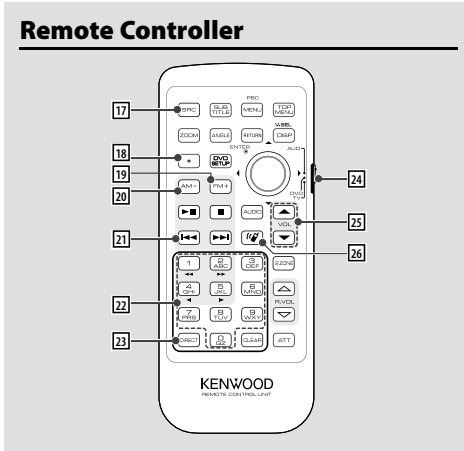

- 17 [SRC] key**
During a call: Ends the call.
- 18 [*] key** (When 24 is set to "AUD")
Number dial input: Inputs "+".
- 19 [FM+] key** (When 24 is set to "AUD")
Number dial input: Inputs "#".
- 20 [AM-] key** (When 24 is set to "AUD")
Number dial input: Inputs "*".
- 21 [clear call] key** (When 24 is set to "AUD")
Number dial input:
Clears the entered phone number.
- 22 [0] – [9] key** (When 24 is set to "AUD")
Number dial input: Inputs a phone number digit.
- 23 [DIRECT] key** (When 24 is set to "AUD")
Make a call.
- 24 Remote Control Mode selector switch**
Switch to "AUD" when dialing.
- 25 [▲]/[▼] key**
During a call: Adjusts the voice volume.
- 26 [hands-free] key**
Displays the Hands-Free Control screen.
When a call comes in: Answers the call.



- The voice volume level adjusted during a call will be effective for the next and subsequent calls.

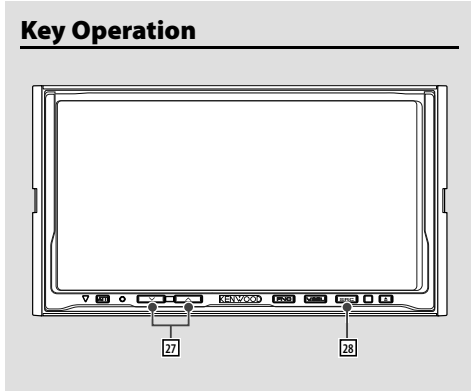

- 27 [▲]/[▼] key**
During a call: Adjusts the voice volume.
- 28 [SRC] key**
During a call: Ends the call.

Operation of hands-free phoning (Model-E)

Making a call

Dial a number

1. Enter a phone number

Press the number ([0] – [9]), [+], [*], or [*] button.

2. Make a call

Press the [] button.

☞ To clear your incorrect entry, press [**Clear**] button.

Speed dialing (Preset dial)

1. Select the preset dial number

Press the [**P1**] – [**P3**] button.



2. Make a call

Press the [] button.

☞ You need to register the preset dial number. (page 21)

Calling a number in the call log

1. Enter the call log mode

Press the [] (outgoing call) or [] (incoming call) button.

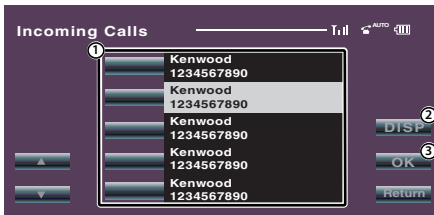

- ① Enters the destination name.
- ② Change to record of redial list.
- ③ Enters the destination data and returns to the Hands-Free Control screen.

2. Select a name or phone number

Press the [] button.

3. Confirm the destination

Press the [**OK**] button.

4. Make a call

Press the [] button.

Calling a number in the Phone Book

1. Enter the Phone Book mode

Press the [] button.

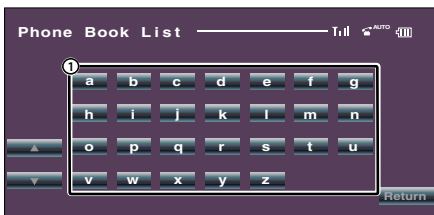

- ① Displays the Phone Book beginning with the name whose first character you have touched.
2. Select the initial character of a person name in memory
Press the character ([**a**] etc.) button.



- ① Enters the destination name.
 - ② Enters the destination data and returns to the Hands-Free Control screen.
 3. Select a destination you wish to call
Press the [**Name**] button.
 4. Confirm the destination
Press the [**OK**] button.
 5. Make a call
Press the [] button.
- ☞ To use the Phone Book, it must have been downloaded from the cell-phone. For details, see <Downloading the Phone Book> (page 13).



- Up to 16 characters can be displayed for each name in the Phone Book.
- Initials including no corresponding name will not be displayed.
- During search, a non-accent character such as "u" is searched for instead of an accent character such as "ü".

Receiving a call

Answering a Phone Call

Press the [] button.

Rejecting an Incoming Call

Press the [] button.

During a call

Disconnecting a Call

Press the [] button.

Other functions

Registering to the Preset Dial Number List

1. Enter the phone number you wish to register

Enter the phone number with reference to the following:
Dial a number/ Calling a number in the call log/
Calling a number in the Phone Book

2. Select the button you wish to register

Press the [**P1**] – [**P3**] button for at least 2 seconds.

Setting up the Hands-Free Phone

Press the [**SetUp**] button on Hands-Free Control screen.

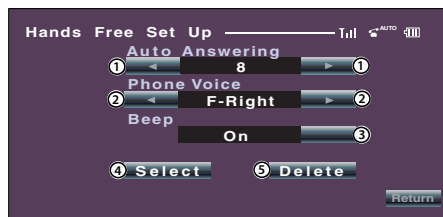

- ① Sets an automatic response time after call termination. (📌 "8")
"Off": This function can not use.
"0-99": Sets to calling ring time (second).
- ② Sets a ringing tone output position. (📌 "F-Right")
"F-Left": Outputs the tone from the front left-hand side speaker.
"F-Right": Outputs the tone from the front right-hand side speaker.
"Front All": Outputs the tone from the both front speakers.
- ③ Set the beep of the incoming call. (📌 "On")
"On": Beep is heard.
"Off": Beep is canceled.
- ④ Display the Phone Select screen.
- ⑤ Display the Phone Delete screen.



- Select the speaker which is further from the microphone in order to prevent howling or echoes.

Selecting a Hands-Free Phone

1. Display the Hands-Free Set Up screen

Press the [**SetUp**] button on Hands-Free Control screen.

2. Display the Phone Select list

Press the [**Select**] button on Hands-Free Set Up screen.



3. Select a Hands-Free phone you wish to use

Press the [**Kenwood 1**] button.



- If a cell-phone is already selected, deselect it, and then select a different one.
- The firmware version "BT200 FW ****" is displayed at the end of the Bluetooth device list.
For how to update the firmware, access our website.
<http://www.kenwood.com/bt/information/>
- The audio player is displayed on the device list after the registration. However, the audio player on the list cannot be selected.

Deleting the Hands-Free Phone

1. Display the Hands-Free Set Up screen

Press the [**SetUp**] button on Hands-Free Control screen.

2. Display the Phone Delete list

Press the [**Delete**] button on Hands-Free Set Up screen.



3. Select a Hands-Free phone you wish to delete

Press the [**Kenwood 1**] button.



- The Phone Book, outgoing call list, and incoming call list are deleted together with the deleted Hands-Free phone.
- The firmware version "BT200 FW ****" is displayed and cannot be deleted.

Appendix

Model List

The receiver units that can be used with KCA-BT200 are as follows: (As of February 2008)

For details on the compatible receivers to be released in the future, access the following URL:

<http://www.kenwood.com/bt/information/>

| Model name | Group | Type switch | | |
|-------------|-------|-------------|-----|-----|
| | | 1 | 2 | 3 |
| DDX5022 | G | OFF | ON | OFF |
| DDX5032 | G | OFF | ON | OFF |
| DDX5032M | G | OFF | ON | OFF |
| DDX512 | G | OFF | ON | OFF |
| DDX6019 | E | OFF | OFF | ON |
| DDX6029 | E | OFF | OFF | ON |
| DDX6039 | E | OFF | OFF | ON |
| DDX7019 | F | OFF | OFF | ON |
| DDX7029 | F | OFF | OFF | ON |
| DDX7032 | G | OFF | ON | OFF |
| DDX7032 | G | OFF | ON | OFF |
| DDX7039 | F | OFF | OFF | ON |
| DDX7039M | F | OFF | OFF | ON |
| DDX712 | G | OFF | ON | OFF |
| DDX8019 | F | OFF | OFF | ON |
| DDX8029 | F | OFF | OFF | ON |
| DDX8039 | F | OFF | OFF | ON |
| DNX210EX | D-1 | OFF | OFF | ON |
| DNX5120 | G | OFF | ON | OFF |
| DNX512EX | G | OFF | ON | OFF |
| DNX5220 | G | OFF | ON | OFF |
| DNX52RY | G | OFF | ON | OFF |
| DNX7100 | F | OFF | OFF | ON |
| DNX710EX | F | OFF | OFF | ON |
| DNX7120 | G | OFF | ON | OFF |
| DNX7200 | F | OFF | OFF | ON |
| DNX7220 | G | OFF | ON | OFF |
| DNX7320 | G | OFF | ON | OFF |
| DPX302 | D-1 | OFF | OFF | ON |
| DPX501 | D-1 | ON | OFF | ON |
| DPX501U | D-1 | ON | OFF | ON |
| DPX502 | D-1 | OFF | OFF | ON |
| DPX502U | D-1 | OFF | OFF | ON |
| DPX701 | D-1 | OFF | OFF | ON |
| DPX701U | D-1 | OFF | OFF | ON |
| DPX-MP2090U | D-1 | ON | OFF | ON |
| DPX-MP2100 | D-1 | OFF | OFF | ON |
| DPX-MP3110 | C | ON | OFF | OFF |
| DPX-MP3110S | C | ON | OFF | OFF |
| DPX-MP4110 | C | ON | OFF | OFF |
| DPX-MP4110S | C | ON | OFF | OFF |
| DPX-MP5100U | D-1 | OFF | OFF | ON |
| DPX-MP5110U | C | ON | OFF | OFF |
| DPX-MP7090U | D-1 | OFF | OFF | ON |
| I-K7 | B-2 | OFF | OFF | ON |
| KDC-MP2035 | D-1 | OFF | OFF | ON |
| KDC-MP235 | D-1 | OFF | OFF | ON |
| KDC-MP238 | D-4 | OFF | OFF | ON |
| KDC-MP3035 | D-1 | OFF | OFF | ON |

| Model name | Group | Type switch | | |
|--------------|-------|-------------|-----|-----|
| | | 1 | 2 | 3 |
| KDC-MP335 | D-1 | OFF | OFF | ON |
| KDC-MP338 | A-1 | ON | OFF | OFF |
| KDC-MP4036AX | D-1 | OFF | OFF | ON |
| KDC-MP4036U | D-1 | OFF | OFF | ON |
| KDC-MP4039 | A-1 | ON | OFF | OFF |
| KDC-MP408U | A-1 | ON | OFF | OFF |
| KDC-MP435U | D-1 | OFF | OFF | ON |
| KDC-MP438U | A-1 | ON | OFF | OFF |
| KDC-MP439 | D-4 | OFF | OFF | ON |
| KDC-MP5033U | D-1 | ON | OFF | ON |
| KDC-MP5036U | D-1 | OFF | OFF | ON |
| KDC-MP5039U | A-1 | ON | OFF | OFF |
| KDC-MP532U | D-1 | ON | OFF | ON |
| KDC-MP535U | D-1 | OFF | OFF | ON |
| KDC-MP538U | B-2 | OFF | OFF | ON |
| KDC-MP5539U | A-1 | ON | OFF | OFF |
| KDC-MP6036 | D-1 | OFF | OFF | ON |
| KDC-MP6039 | B-2 | OFF | OFF | ON |
| KDC-MP632U | D-1 | ON | OFF | ON |
| KDC-MP635 | D-3 | OFF | OFF | ON |
| KDC-MP638U | B-1 | OFF | OFF | ON |
| KDC-MP6539U | B-2 | OFF | OFF | ON |
| KDC-MP735U | D-3 | OFF | OFF | ON |
| KDC-MP738U | B-1 | OFF | OFF | ON |
| KDC-MP832U | D-3 | OFF | OFF | ON |
| KDC-W3537 | D-1 | OFF | OFF | ON |
| KDC-W3541A | A-2 | ON | OFF | OFF |
| KDC-W3541G | A-2 | ON | OFF | OFF |
| KDC-W4037 | D-1 | OFF | OFF | ON |
| KDC-W4041 | A-1 | ON | OFF | OFF |
| KDC-W4041W | A-1 | ON | OFF | OFF |
| KDC-W4141 | A-1 | ON | OFF | OFF |
| KDC-W4141WY | A-1 | ON | OFF | OFF |
| KDC-W4537U | D-1 | OFF | OFF | ON |
| KDC-W4737U | D-1 | OFF | OFF | ON |
| KDC-W5137 | D-1 | OFF | OFF | ON |
| KDC-W5141U | A-1 | ON | OFF | OFF |
| KDC-W5534U | D-1 | ON | OFF | ON |
| KDC-W5541U | A-1 | ON | OFF | OFF |
| KDC-W5641UY | A-1 | ON | OFF | OFF |
| KDC-W6041U | B-2 | OFF | OFF | ON |
| KDC-W6141UY | B-2 | OFF | OFF | ON |
| KDC-W6534U | D-1 | ON | OFF | ON |
| KDC-W6537U | D-1 | OFF | OFF | ON |
| KDC-W6541U | B-2 | OFF | OFF | ON |
| KDC-W6641UY | B-2 | OFF | OFF | OFF |
| KDC-W7037 | D-3 | OFF | OFF | ON |
| KDC-W7041U | B-1 | OFF | OFF | ON |
| KDC-W7141UY | B-1 | OFF | OFF | OFF |

| Model name | Group | Type switch | | |
|------------|-------|-------------|-----|-----|
| | | 1 | 2 | 3 |
| KDC-W7534U | D-3 | OFF | OFF | ON |
| KDC-W7537U | D-3 | OFF | OFF | ON |
| KDC-W7541U | B-1 | OFF | OFF | OFF |
| KDC-W9537U | D-2 | OFF | OFF | ON |
| KDC-X491 | D-1 | OFF | OFF | ON |
| KDC-X492 | A-1 | ON | OFF | OFF |
| KDC-X590 | D-1 | ON | OFF | ON |
| KDC-X591 | D-1 | OFF | OFF | ON |
| KDC-X592 | B-2 | OFF | OFF | OFF |
| KDC-X692 | B-1 | OFF | OFF | OFF |
| KDC-X7006 | D-3 | OFF | OFF | ON |
| KDC-X7006U | D-3 | OFF | OFF | ON |
| KDC-X7009U | B-1 | OFF | OFF | OFF |
| KDC-X7533U | D-1 | ON | OFF | ON |
| KDC-X791 | D-3 | OFF | OFF | ON |
| KDC-X792 | B-1 | OFF | OFF | OFF |
| KDC-X8006U | D-2 | OFF | OFF | ON |
| KDC-X8009U | B-1 | OFF | OFF | OFF |
| KDC-X890 | D-3 | OFF | OFF | ON |
| KDC-X891 | D-2 | OFF | OFF | ON |
| KDC-X9006U | D-2 | OFF | OFF | ON |

| Model name | Group | Type switch | | |
|--------------|-------|-------------|-----|-----|
| | | 1 | 2 | 3 |
| KDC-X9533U | D-3 | OFF | OFF | ON |
| KDC-X991 | D-2 | OFF | OFF | ON |
| KDV-412 | D-1 | ON | OFF | ON |
| KDV-5234 | D-1 | ON | OFF | ON |
| KDV-MP6333 | D-1 | ON | OFF | ON |
| KDV-MP6433 | D-1 | ON | OFF | ON |
| KOS-V1000 | F | OFF | OFF | ON |
| KOS-V500 | F | OFF | OFF | ON |
| KVT-500VDVRY | G | OFF | ON | OFF |
| KVT-512 | G | OFF | ON | OFF |
| KVT-5220DVD | G | OFF | ON | OFF |
| KVT-5320DVD | G | OFF | ON | OFF |
| KVT-5320DVD | G | OFF | ON | OFF |
| KVT-5320VDM | G | OFF | ON | OFF |
| KVT-7190DVD | F | OFF | OFF | ON |
| KVT-7290DVD | F | OFF | OFF | ON |
| KVT-7390DVD | F | OFF | OFF | ON |
| KVT-8190DVD | F | OFF | OFF | ON |
| KVT-8290DVD | F | OFF | OFF | ON |
| KVT-8390DVD | F | OFF | OFF | ON |
| U737 | B-1 | OFF | OFF | OFF |

About Bluetooth Icons

The control unit supporting the icon display function can display the following statuses:

- Bluetooth cell-phone connection status**

BT : This indicator turns on when a cell-phone is connected.

- Signal strength of cell-phone**

Maximum Minimum

- Battery level of cell-phone**

Full Nearly dead



- Icons are not displayed if information cannot be obtained from the cell-phone.

- Since the number of steps of the control unit is different from that of the cell-phone, the statuses displayed on the control unit may discord from those displayed on the cell-phone.

Menu Glossary

- "D-STATUS"/"P-STATUS" (Displaying the Bluetooth device Status)**

You can display the connection status, signal strength, and battery level.

"HF CONNECT"/"BT-CON"/"HF-CON": Bluetooth cell-phone connection status.

"AD CONNECT"/"AD CON": Bluetooth Audio connection status.

"BAT": Battery level of cell-phone.

"SGNL": Signal strength of cell-phone.

- **“ANS”/“Auto Answer” (Setting the Time Interval for Automatic Answer)**

This function automatically answers (responds to) a call after lapse of the preset time interval for automatic answer.

“OFF”: Does not answer the phone call automatically.

“0”: Automatically answers the phone call at once.

“1” – “99”: Automatically answers the phone call after lapse of 1 – 99 seconds.

☞ If the time set in the cell-phone is shorter than that set in the unit, the former will be used.

- **“SPK”/“SP Select” (Setting up the Voice Output Speakers)**

You can specify the voice output speakers.

“Front”/“FRT”: Outputs voice from the front-left and front-right speakers.

“F-R”: Outputs voice from the front-right speaker.

“F-L”: Outputs voice from the front-left speaker.

☞ Select the speaker which is further from the microphone in order to prevent howling or echoes.

- **“C-BP”/“Call Beep”/“Beep” (Setting the Beep of the Incoming Call)**

You can output a beep from the speaker when a call comes in.

“ON”: Beep is heard.

“OFF”: Beep is canceled.

Function note

- **Dial a number**

- Depending on the type of your control unit, “#” (all segments are lit) is displayed for #.

- **Calling a number in the call log**

- The outgoing call list and the incoming call list, and the missed call list are the lists of calls originated from and received at this unit. They are not the ones stored in the cell-phone memory.

- **Calling a number in the Phone Book**

- To use the Phone Book, it must have been downloaded from the cell-phone. For details, see <Downloading the Phone Book>.
- Up to 19 characters can be displayed for each name in the Phone Book.
- During search, a non-accent character such as “u” is searched for instead of an accent character such as “ü”. The non-alphabetical characters such as Chinese and Russian are classified as symbol.

- **Switching to the Private Mode**

- Depending on the type of your cell-phone, switching to the private talk mode may select the source that was used before commencing the hands-free connection. If this happens, the source cannot be switched back to the hands-free talk mode by operating this unit. Operate your cell-phone to return to the hands-free talk mode.

- **Switching between Display Modes**

- Depending on the type of your control unit, the following restrictions are placed.
 - Up to 19 characters can be displayed.
 - The # letter cannot be displayed, or “#” (all segments are lit) is displayed for #.
 - You cannot switch between display modes.

FCC Notice

This device complies with part 15 of the FCC rules.

Operation is subject to the following two conditions:

(1) this device may not cause harmful interference, and (2) this device must accept any interference received, including interference that may cause undesired operation.

CAUTION:

To maintain compliance with FCC’s RF exposure guidelines, use only the supplied antenna.

Unauthorized antenna, modification, or attachments could damage the transmitter and may violate FCC regulations.

IC Regulatory Information

This device complies with RSS210 of Industry Canada.

Operation is subject to the following two condition:

(1) this device may not cause interference, and (2) this device must accept any interference, including interference that may cause undesired operation of this device.

This Class B digital apparatus complies with Canadian ICES-003.

Information on Disposal of Old Electrical and Electronic Equipment (applicable for EU countries that have adopted separate waste collection systems)



Products with the symbol (crossed-out wheeled bin) cannot be disposed as household waste.

Old electrical and electronic equipment should be recycled at a facility capable of handling these items and their waste byproducts. Contact your local authority for details in locating a recycle facility nearest to you. Proper recycling and waste disposal will help conserve resources whilst preventing detrimental effects on our health and the environment.

Accessories/ Installation Procedure

Accessories

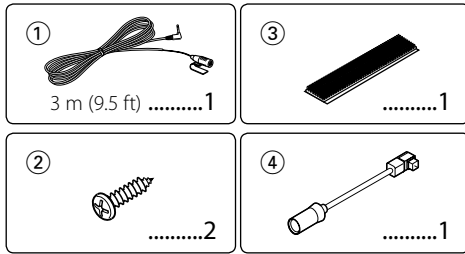

Installation Procedure

1. To prevent a short circuit, remove the key from the ignition and disconnect the ⊖ battery.
2. Set the Type switch.
3. Make the proper input and output wire connections for each unit.
4. Install the unit in your car.
5. Reconnect the ⊖ battery.
6. Press the reset button on the control unit.



- Insulate unconnected wires with vinyl tape or other similar material. To prevent a short circuit, do not remove the caps on the ends of the unconnected wires or the terminals.
- After the unit is installed, check whether the brake lamps, blinkers, wipers, etc. on the car are working properly.

For Good Reception

To assure good reception, note the following:

- Communicate with the cell-phone within the line-of-sight distance of 10 m (30 ft). The communication range becomes shorter depending on the surrounding environment. The communication range also becomes shorter when there is an obstacle between this unit and the cell-phone. The above maximum communication range (10 m) is not always assured.
- Keep this unit away from other electric components (AV components) as far as possible. If they are near, call connection can fail, TV or radio noise can be generated, or poor reception can occur.
- A broadcast station or walkie-talkie located nearby can interfere with communication due to too strong signal.

Setting the Type Switch

Set the Type switch according to the type of the control unit connected. See the model list in <Appendix> (page 22).

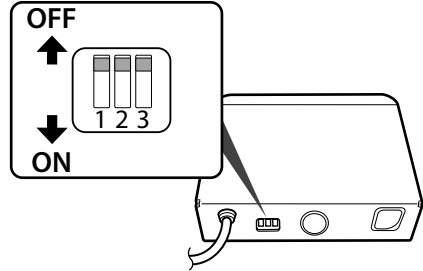

1: Display Character Conversion Function

When the control unit cannot display accent characters ("u", "a", etc.), it converts these characters to upper-case alphabetic characters.

OFF: Do not convert characters.

ON: Convert characters.

2: Specifying the Connector to Connect

Specify the type of the connector to be connected to the control unit.

OFF: Use the 5L connector.

ON: Use the KAB connector.

3: Specifying the Control Unit Type

Specify the type of the control unit to connect to.

OFF: Set when no control unit type is specified in Model list, or the control unit type is not in the model list.

ON: Set when the control unit type is specified in Model list.

Connection

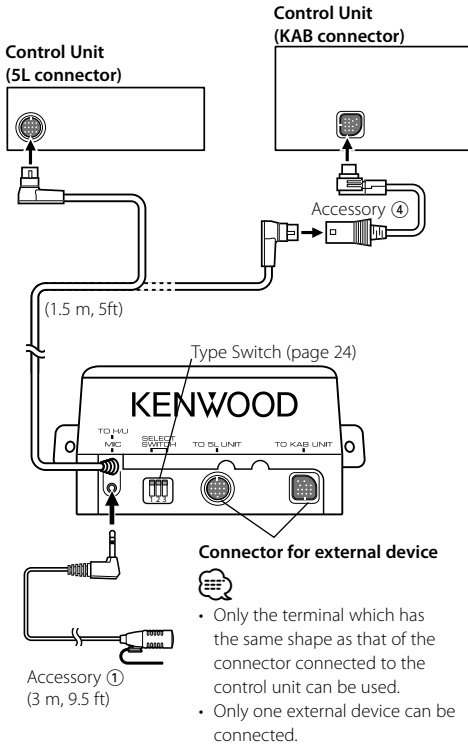

If You Want to Connect KCA-S220A

Connect the Hands-Free Box to the terminal labelled TO CHANGER 2.

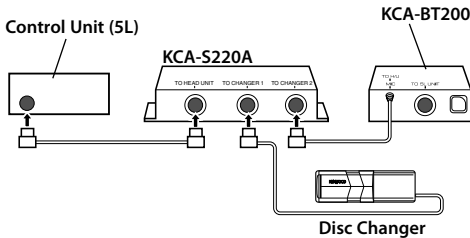

- Please keep the total extension of the control cable from the control unit to the disc changer to 13 m (43 ft) or less. Control cable lengths in excess of 13 m will cease to function properly.

Installation

Installation the Microphone Unit

- 1 Check the installation position of the microphone (accessory ①).
- 2 Remove oil and other dirt from the installation surface.
- 3 Install the microphone.
- 4 Wire the microphone cable up to the hands-free box with it secured at several positions using tape or the like.

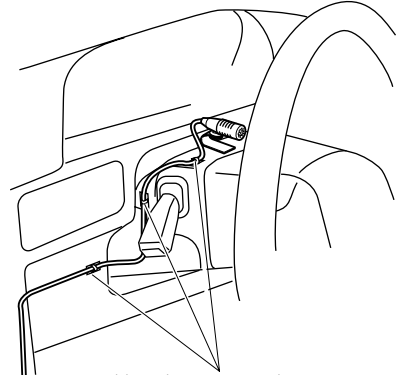

Fix a cable with a commercial item of tape.

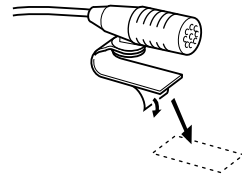

Peel the release coated paper of double-face adhesive tape to fix on the place shown above.

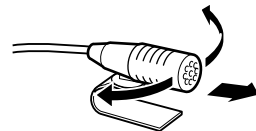

Adjust the direction of the microphone to the driver.



- Install the microphone as far as possible from the cell-phone.

Installation

Installation the Bluetooth unit



- Determine the installation position after making sure that the unit can communicate with the Bluetooth device.
- Please do not install the unit near the dashboard, the rear tray, or other important components. Doing so could lead to injury or accident should the unit come off due to a shock and strike a person or an important component. Tapping screws should be used for mounting. (Attachment with velcro strips, although easy, can come off with a shock.)

Securing to audio board

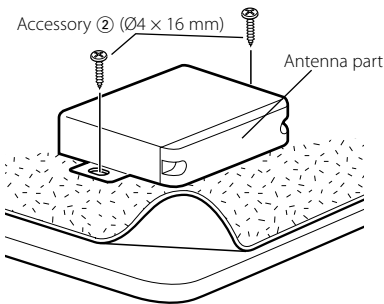

Securing to pile carpet

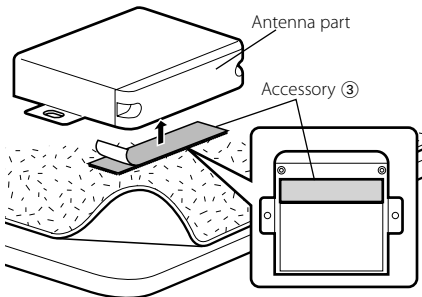

- Do not stick the velcro tape over the serial number.
- If the installation place is stepped, cut the velcro tape into two pieces and stick them at two positions.

Troubleshooting Guide

What might seem to be a malfunction in your unit may just be the result of slight misoperation or miswiring. Before calling service, first check the following table for possible problems.

? The hands-free talk volume is low.

- ✓ The hands-free talk volume is set at a low level.
 - ☞ The hands-free talk volume can be adjusted independently. Adjust it during hands-free talk.

? No sound is heard from the rear speakers.

- ✓ You are talking in the hand-free talk mode.
 - ☞ No sound is heard from the rear speakers in the hands-free talk mode.

? No beep is heard at reception of an incoming call.

- ✓ No beep is heard depending on the type of your cell-phone.
 - ☞ The <Setting the Beep of the Incoming Call> is set ON.

? Voice is not recognized.

- ✓ The vehicle window is open.
 - ☞ If the surrounding noise is large, voice cannot be recognized properly. Close the vehicle windows to reduce noise.
- ✓ Small voice.
 - ☞ If voice is too small, it cannot be recognized properly. Speak into the microphone a little more loudly and naturally.
- ✓ The person uttering the voice tag is not the one who registered the it.
 - ☞ Only the voice of the person who registered the voice tag can be recognized.

? The Bluetooth audio player cannot be registered (pairing).

- ✓ The PIN code is fixed.
 - ☞ When a PIN code is specified in the Instruction Manual for Bluetooth Audio Player, register it with reference to <Registering PIN Code> to register the Bluetooth audio player. If no PIN code is specified in the Instruction Manual, try "0000".

? The sound from the Bluetooth audio player is discontinuous.

- ✓ The distance between this unit and audio player is too far.
 - ☞ Move the audio player nearer to this unit.
- ✓ Another Bluetooth device is affecting the Bluetooth communication.
 - ☞ Turn off another Bluetooth device.
 - ☞ Move another Bluetooth device away from this unit.

The messages shown below display your systems condition.

- No Number/ NO-NUMBER/ Incoming No Number :
- The calling party does not notify a caller ID.
 - There is no phone number data.

Specifications

No Data/ NO DATA :

- There is no outgoing call list.
- There is no incoming call list.

No Entry/ NO ENTRY :

The cell-phone has not been registered (pairing).

HF Disconnect/ HF DISCONCT/ HF D-CON/ Disconnect/ DISCONCT/ Non Connection/ Disconnected :

The unit cannot communicate with the cell-phone.

Audio Disconnect/ AUD DISCONCT/ AD D-CON :

The unit cannot communicate with the audio player.

HF Connect/ HF CONNECT/ Connect/ CONNECT :

The unit can communicate with the cell-phone.

HF Error 07/ HF ERR07:

The memory cannot be accessed.

- ➔ Turn off the power and on again. If this message still appears, press the reset button on the control unit.

HF Error 68/ HF ERR68:

The unit cannot communicate with the cell-phone.

- ➔ Turn off the power and on again. If this message still appears, press the reset button on the control unit.

Unknown: The Bluetooth device cannot be detected.

Device Full/ DVC FULL:

5 Bluetooth device have already been registered. No more Bluetooth device cannot be registered.

PIN Code NG/ CODE NG:

The PIN code is wrong.

Connect NG/ CONCT NG:

The unit cannot be connected to the device.

Pairing Failed/ PAIRING NG/ PAIR NG:

Pairing error.

Err No Matching/ NO MATCHING/ NO MATCH:

The voice tag is wrong. Voice cannot be recognized because of an unregistered voice tag, etc.

Too Soft: Voice is too small and cannot be recognized.

Too Loud: Voice is too large to be recognized.

Too Long: The word or utterance is too long to be recognized.

No Phonebook/ NO PB:

Data is not contained in the phone book.

No Message/ NO SMS:

No short message in In Box.

Bluetooth section

Technology

: Bluetooth 1.2 Certified

Frequency

: 2.402 – 2.480 GHz

Output Power

: +4dBm (MAX), 0dBm (AVE) Power Class 2

Maximum Communication range

: Line of sight approx.10m (32.1 ft)

Profiles

: HFP (Hands Free Profile)

: HSP (Headset Profile)

: OPP (Object Push Profile)

: PBAP (Phonebook Access Profile)

: SYNC (Synchronization Profile)

: SPP (Serial Port Profile)

: A2DP (Advanced Audio Distribution Profile)

: AVRCP (Audio/Video Remote Control Profile)

General

Operating voltage (10.5 – 16V allowable)

: 14.4 V

Current consumption

: 200 mA

Dimension (W x H x D)

: 95 x 30 x 105 mm

3-3/4 x 1-3/16 x 4-1/8 inch

Weight

: 0.37 kg (0.82 lbs)