

RAPID CHARGER

KSC-35S

SERVICE MANUAL

T version

KENWOOD

Kenwood Corporation

© 2011-4 PRINTED IN JAPAN
B51-8975-00 (K) PDF

This product (KSC-35S) is different from the KSC-35.
Do not use the KSC-35 AC adapter.

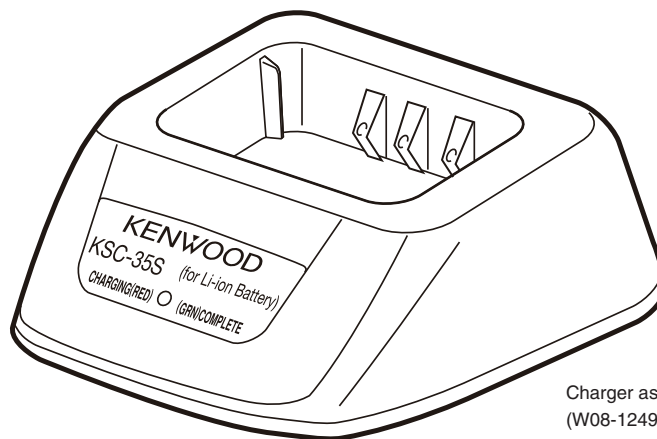

CONTENTS

PARTS LIST	2
SPECIFICATIONS	2
PC BOARD	3
SCHEMATIC DIAGRAM	4
FLOW CHART	5
BATTERY PACK	
KNB-45L (Li-ion Battery Pack)	BACK COVER
KNB-63L (Li-ion Battery Pack)	BACK COVER

KSC-35S

Document Copyrights

Copyright 2011 by Kenwood Corporation. All rights reserved.

No part of this manual may be reproduced, translated, distributed, or transmitted in any form or by any means, electronic, mechanical, photocopying, recording, or otherwise, for any purpose without the prior written permission of Kenwood.

Disclaimer

While every precaution has been taken in the preparation of this manual, Kenwood assumes no responsibility for errors or omissions. Neither is any liability assumed for damages resulting from the use of the information contained herein. Kenwood reserves the right to make changes to any products herein at any time for improvement purposes.

PARTS LIST

* : New Parts

Ref. No.	Address	New parts	Parts No.	Description	Destination
KSC-35S					
		*	W08-1251-05	AC ADAPTER	
			W08-1249-05	CHARGER ASSY	

SPECIFICATIONS

AC Voltage	100~240V
Dimensions (W x H x D)	86.3 x 43.2 x 100.0 mm
Weight (charger only)	Approx. 95g
Approximate Charging Times	
KNB-45L (Li-ion : 7.4V, 2000mAh).....	180 minutes
KNB-63L (Li-ion : 7.4V, 1130mAh).....	180 minutes

PC BOARD KSC-35S

CHARGER UNIT Component side view

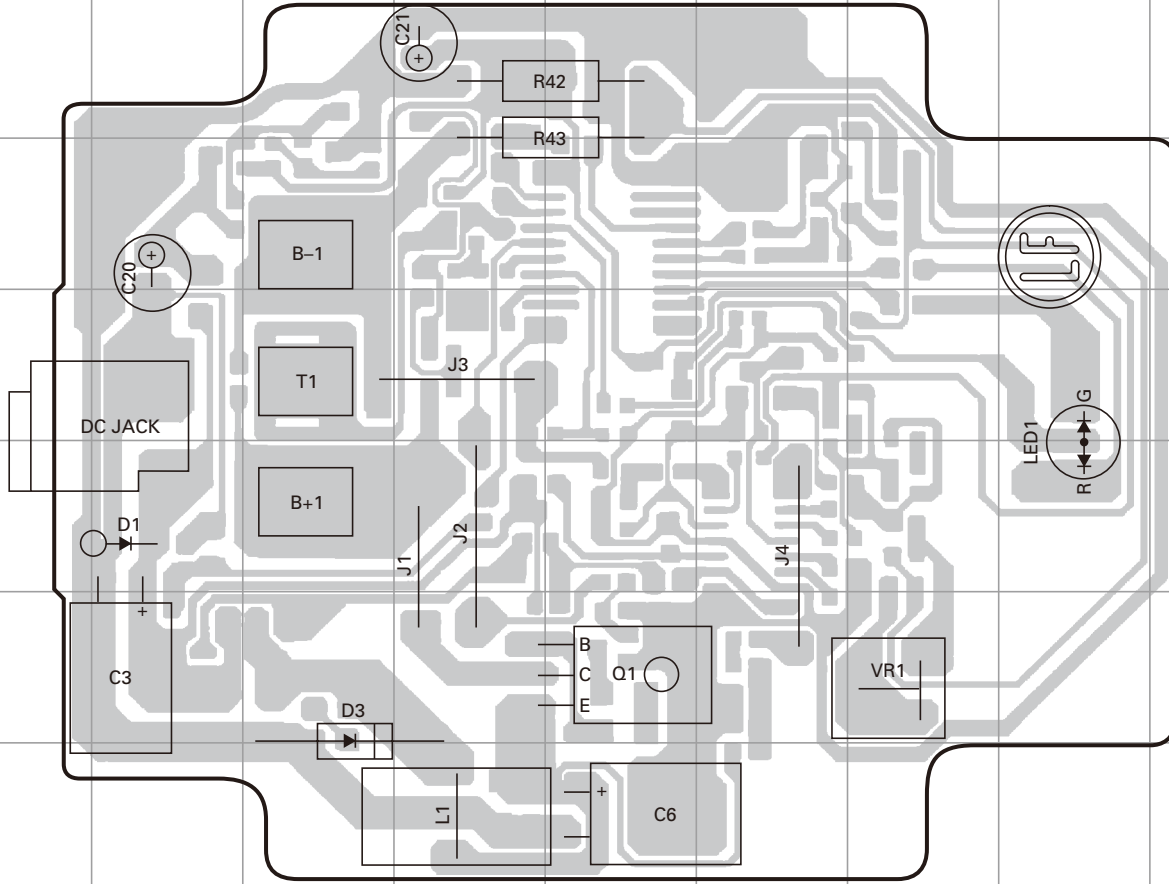

Ref. No.	Address
Q1	6E
D1	5B
D3	6C
LED1	5H

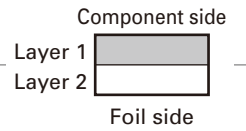

CHARGER UNIT Foil side view

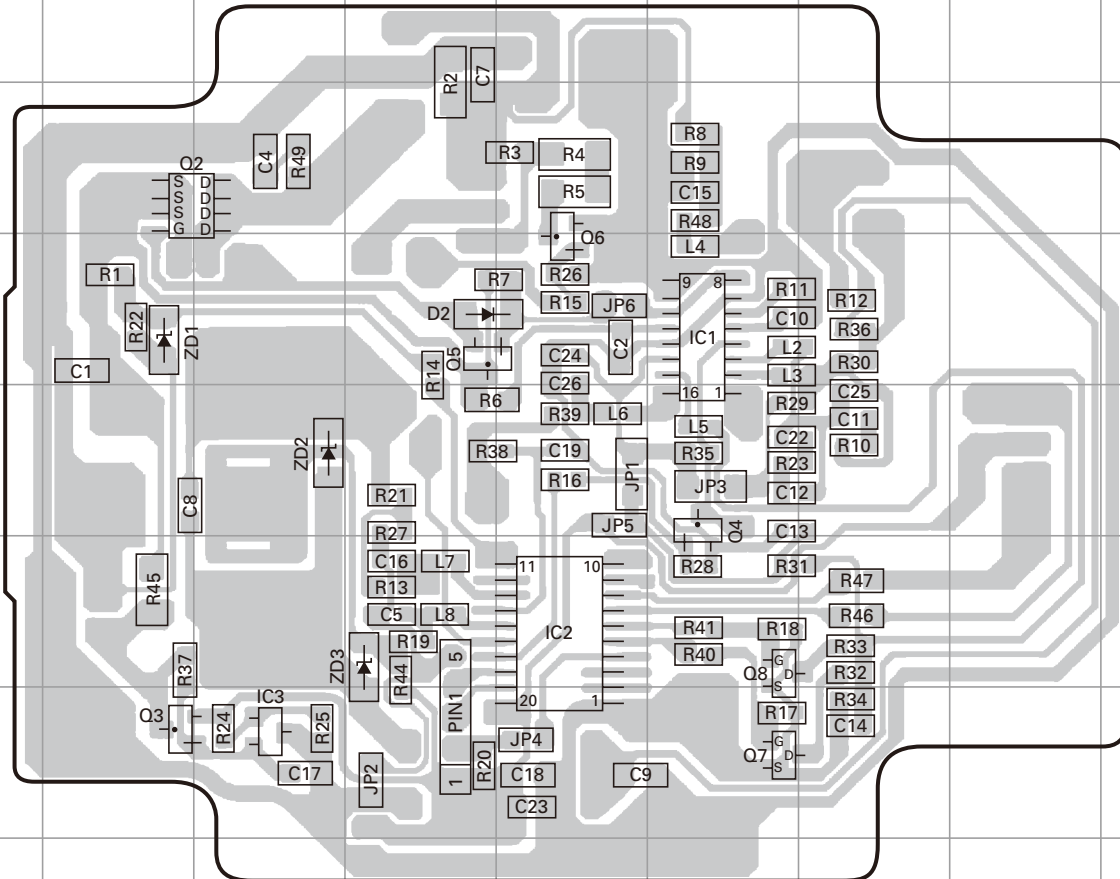

Ref. No.	Address
IC1	10F
IC2	12E
IC3	13C
Q2	9B
Q3	13B
Q4	11F
Q5	10D
Q6	10E
Q7	13F
Q8	12F
D2	10D
ZD1	10B
ZD2	11C
ZD3	12D

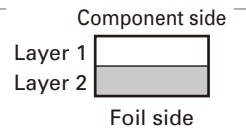

KSC-35S SCHEMATIC DIAGRAM

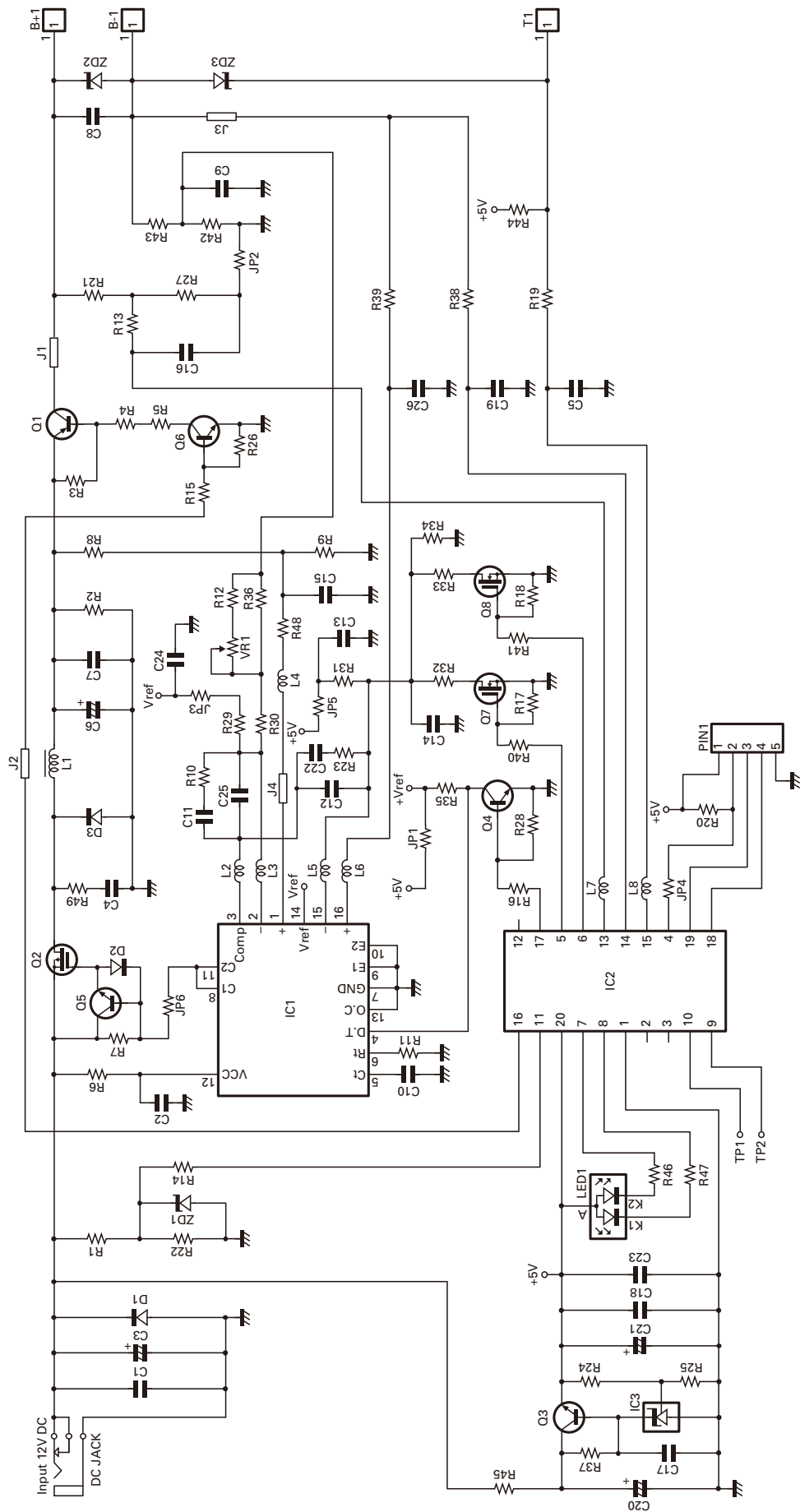

FLOW CHART

- About voltage write down,
 $V_B = (B1 + \text{voltage}) - V_f$ ($V_f \approx 0.25V_{dc}$)
 Therefore battery voltage must consider V_f of protected reverse connection diode.
- Battery voltage should be kept inspecting when charge condition and on temperature stand-by condition.

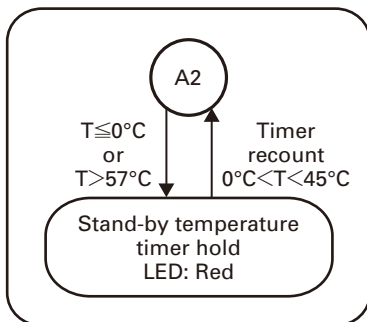
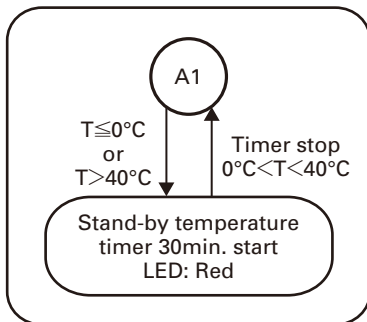
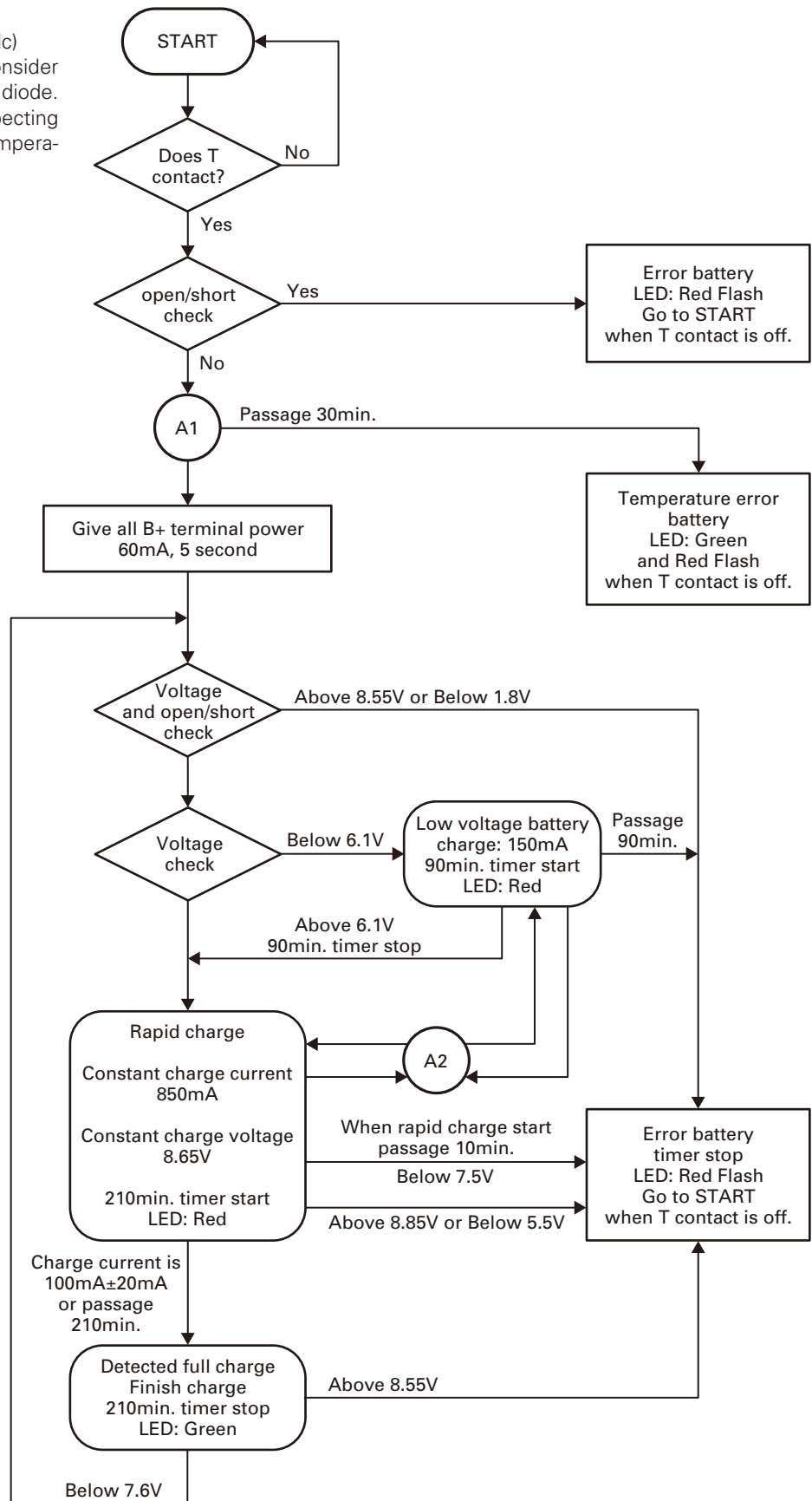

KSC-35S

BATTERY PACK

KNB-45L (Li-ion Battery Pack)

■ External View



■ Specifications

Voltage.....7.4V
Battery capacity..... 2000mAh

KNB-63L (Li-ion Battery Pack)

■ External View



■ Specifications

Voltage.....7.4V
Battery capacity..... 1130mAh

Kenwood Corporation

2967-3, Ishikawa-machi, Hachioji-shi, Tokyo, 192-8525 Japan

Kenwood U.S.A. Corporation

P.O. BOX 22745, 2201 East Dominguez Street, Long Beach,
CA 90801-5745, U.S.A.

Kenwood Electronics Canada Inc.

6070 Kestrel Road, Mississauga, Ontario, Canada L5T 1S8

Kenwood Electronics Deutschland GmbH

Rembrücker Str. 15, 63150 Heusenstamm, Germany

Kenwood Electronics Belgium N.V.

Leuvensesteenweg 248 J, 1800 Vilvoorde, Belgium

Kenwood Electronics France S.A.

L'Etoile Paris Nord 2, 50 Allée des Impressionnistes,
Bp 58416 Villepinte, 95944 Roissy Ch De Gaulle Cedex

Kenwood Electronics UK Limited

KENWOOD House, Dwight Road, Watford, Herts.,
WD18 9EB United Kingdom

Kenwood Electronics Europe B.V.

Amsterdamseweg 37, 1422 AC Uithoorn, The Netherlands

Kenwood Electronics Italia S.p.A.

Via G. Sirtori, 7/9 20129 Milano, Italy

Kenwood Ibérica, S.A.

Bolivia, 239-08020 Barcelona, Spain

Kenwood Electronics Australia Pty. Ltd.

Talavera Business Park Building A, 4 Talavera Road,
North Ryde NSW 2113 Australia

Kenwood Electronics (Hong Kong) Ltd.

Suite 2504, 25/F, Tower 2, Nina Tower, No. 8 Yeung Uk Road,
Tsuen Wan, New Territories, Hong Kong

Kenwood Electronics Singapore Pte Ltd

1 Ang Mo Kio Street 63, Singapore 569110