

# KENWOOD

COMPACT Hi-Fi COMPONENT SYSTEM

## C-717DV

### INSTRUCTION MANUAL

Kenwood Corporation



© B60-5860-08/00 (E)

## **Before applying power**





**⚠ Caution : Read this page carefully to ensure safe operation.**

Units are designed for operation as follows.

Europe ..... AC 230 V only

### **Safety precautions**

**WARNING : TO PREVENT FIRE OR ELECTRIC SHOCK, DO NOT EXPOSE THIS APPLIANCE TO RAIN OR MOISTURE.**

	<b>CAUTION</b> RISK OF ELECTRIC SHOCK DO NOT OPEN	
CAUTION: TO REDUCE THE RISK OF ELECTRIC SHOCK, DO NOT REMOVE COVER (OR BACK). NO USER-SERVICEABLE PARTS INSIDE. REFER SERVICING TO QUALIFIED SERVICE PERSONNEL.		
	THE LIGHTNING FLASH WITH ARROWHEAD SYMBOL, WITHIN AN EQUILATERAL TRIANGLE, IS INTENDED TO ALERT THE USER TO THE PRESENCE OF UNINSULATED "DANGEROUS VOLTAGE" WITHIN THE PRODUCT'S ENCLOSURE THAT MAY BE OF SUFFICIENT MAGNITUDE TO CONSTITUTE A RISK OF ELECTRIC SHOCK TO PERSONS.	
	THE EXCLAMATION POINT WITHIN AN EQUILATERAL TRIANGLE IS INTENDED TO ALERT THE USER TO THE PRESENCE OF IMPORTANT OPERATING AND MAINTENANCE (SERVICING) INSTRUCTIONS IN THE LITERATURE ACCOMPANYING THE APPLIANCE.	

### **The marking of products using lasers**



The marking this product has been classified as Class 1. It means that there is no danger of hazardous radiation outside the product.

Location: Back panel

The markings of products' certifications.  
Rating label location : Back panel

**2** C-717DV

## **IMPORTANT SAFETY INSTRUCTIONS**

**⚠ Caution : Read this page carefully to ensure safe operation.**

### **Read These Instructions**

– All the safety and operating instructions should be read before the product is operated.

### **Keep These Instructions**

– The safety and operating instructions should be retained for future reference.

### **Heed All Warnings**

– All warnings on the product and in the operating instructions should be adhered to.

### **Follow All Instructions**

– All operating and use instructions should be followed.

#### **1. Clean only with dry cloth**

– Unplug this product from the wall outlet before cleaning. Do not use liquid cleaners or aerosol cleaners. Use a damp cloth for cleaning.

#### **2. Attachments**

– Only use attachments/accessories specified by the manufacturer.

#### **3. Do not use this apparatus near water**

– This product shall not be exposed to dripping and splashing – for example, near a bath tub, wash bowl, kitchen sink, or laundry tub; in a wet basement; or near a swimming pool; and the like. Do not place an object containing liquid, such as a flower vase, on the appliance.

#### **4. Accessories**

– Use only with the cart, stand, tripod, bracket, or table specified by the manufacturer, or sold with the apparatus. When a cart is used, use caution when moving the cart/apparatus combination to avoid injury from tip-over.



## 5. Ventilation

– Slots and openings in the cabinet are provided for ventilation and to ensure reliable operation of the product and to protect it from overheating. Do not block any ventilation openings. Install in accordance with the manufacturer's instructions. The openings should never be blocked by placing the product on a bed, sofa, rug, or other similar surface. This product should not be placed in a built-in installation such as a bookcase or rack unless proper ventilation is provided or the manufacturer's instructions have been adhered to.

## 6. Power Sources

– This product should be operated only from the type of power source indicated on the product. If you are not sure of the type of power supply to your home, consult your product dealer or local power company.

## 7. CAUTION – Polarization

– Do not defeat the safety purpose of the polarized or grounding-type plug. A polarized plug has two blades with one wider than the other. A grounding type plug has two blades and a third grounding prong. The wide blade or the third prong are provided for your safety. If the provided plug does not fit into your outlet, consult an electrician for replacement of the obsolete outlet.

## 8. Power Cord Protection

– Protect the power cord from being walked on or pinched particularly at plugs, convenience receptacles, and the point where they exit from the apparatus.

## 9. Lightning

– Unplug this apparatus during lightning storms or when unused for long periods of time.

## 10. Overloading

– Do not overload wall outlets, extension cords, or integral convenience receptacles as this can result in a risk of fire or electric shock.

## 11. Object and Liquid Entry

– Never push objects of any kind into this product through openings as they may touch dangerous voltage points or short-out parts that could result in a fire or electric shock. Never spill liquid of any kind on the product.

## 12. Servicing

– Do not attempt to service this product yourself as opening or removing covers may expose you to dangerous voltage or other hazards. Refer all servicing to qualified service personnel.

## 13. Damage Requiring Service

– Refer all servicing to qualified service personnel. Servicing is required when the apparatus has been damaged in any way, such as power-supply cord or plug is damaged, liquid has been spilled or objects have fallen into the apparatus, the apparatus has been exposed to rain or moisture, does not operate normally, or has been dropped.

## 14. Replacement Parts

– When replacement parts are required, be sure the service technician has used replacement parts specified by the manufacturer or have the same characteristics as the original part. Unauthorized substitutions may result in fire, electric shock, or other hazards.

## 15. Safety Check

– Upon completion of any service or repairs to this product, ask the service technician to perform safety checks to determine that the product is in proper operating condition.

## 16. Wall or Ceiling Mounting

– This product should be mounted to a wall or ceiling only as recommended by the manufacturer.

## 17. Heat

– Do not install near any heat sources such as radiators, heat registers, stoves, or other apparatus (including amplifiers) that produce heat. Do not place a flaming object, such as a candle or lantern, or near the product.

## 18. Power Lines

– An outside antenna system should not be located in the vicinity of overhead power lines or other electric light or power circuits, or where it can fall into such power lines or circuits. When installing an outside antenna system, extreme care should be taken to keep from touching such power lines or circuits as contact with them might be fatal.

Notes:

Item 7 is not required except for grounded or polarized equipment.

## Before use

### Contents

**Caution : Read the pages marked  carefully to ensure safe operation.**

<b>Before applying power.....</b>	<b>2</b>
Safety precautions .....	2
<b>IMPORTANT SAFETY INSTRUCTIONS .....</b>	<b>2</b>
<b>Before use .....</b>	<b>4</b>
<b>Connections .....</b>	<b>6</b>
<b>Disc information .....</b>	<b>8</b>
<b>Handling discs.....</b>	<b>9</b>
<b>About USB device .....</b>	<b>9</b>
<b>Supported iPod/iPhone .....</b>	<b>9</b>
<b>About MP3 and WMA .....</b>	<b>10</b>
<b>About Video file .....</b>	<b>11</b>
<b>About Picture file.....</b>	<b>11</b>
<b>About SD card .....</b>	<b>11</b>
<b>Usable D.AUDIO .....</b>	<b>11</b>
<b>Component names and functions .....</b>	<b>12</b>
<b>Basic function .....</b>	<b>14</b>
Switching the system on.....	14
Switching the system to standby mode.....	14
Volume control.....	14
Sound control.....	14
Headphones.....	14
<b>Using the DVD/USB device/SD card .....</b>	<b>15</b>
Preparation.....	15
Playing a DVD/ Video CD.....	16
Playing a CD/ audio file/ video file .....	16
Time Search (For DVD, Video CD, CD, audio file only).....	17
File Select (For audio file, video file, picture file only).....	17
Programming chapters/tracks/files .....	18
Random play (except picture file).....	18
Repeat play.....	18
Zoom.....	19
Changing the display information.....	19
<b>DVD Setup .....</b>	<b>20</b>
Switching the video resolution .....	20
Adjust the settings.....	20
<b>Using the iPod/iPhone .....</b>	<b>22</b>
Playing an iPod/iPhone .....	22
Repeat play.....	22
Random play.....	22
<b>Using the D.AUDIO .....</b>	<b>23</b>
Playback of Digital Audio Player.....	23

### Using the AUX .....

    Playing an external component..... 23

### Using the radio .....

    Tuning in radio stations..... 24

    Auto preset..... 24

    Manual preset..... 24

    Tuning to a preset radio station .....

    Using Radio Data System .....

    Changing the Radio Data System display

        information .....

        Tuning by Program Type (PTY search).....

### Clock/timer operation .....

    Clock setting..... 26

    Timer setting .....

    To activate/deactivate the timer.....

    Sleep timer setting.....

### System setup.....

    Adjusting the display brightness (BACKLIGHT).....

    Adjusting the display contrast (CONTRAST).....

    Setting Auto Power Save (A.P.S.).....

### In case of difficulty.....

### General information .....

    Maintenance .....

    To install speakers on a wall.....

### Specifications.....

### Unpacking

Unpack the unit carefully and make sure that all accessories are present.

FM indoor antenna..... (1)

AM loop antenna..... (1)

iPod applied part..... (1)

Remote control unit

    with a built-in button battery (RC-F0717E)..... (1)

AC adapter (AC-18335A)..... (1)

Power cord..... (1)

Stand .....

If any accessories are missing, or if the unit is damaged or falls to operate, notify your dealer immediately. If your unit was shipped to you directly, notify your shipper immediately. Kenwood recommends that you retain the original carton and packing materials in case you need to move or ship the unit in the future.

**Keep this manual handy for future reference.**

## How to read this manual

Most of the functions are designed to be able to operate from the remote control unit.

## Preparing the remote control unit

Pull the battery sheet out from the remote control unit to the direction of the arrow.



## Operation

When the power cord is plugged in, **STANDBY/TIMER** indicator is lit. The power turns ON by pressing  button on the remote control unit pointing at the remote sensor. When the power comes on, press the button you want to operate.

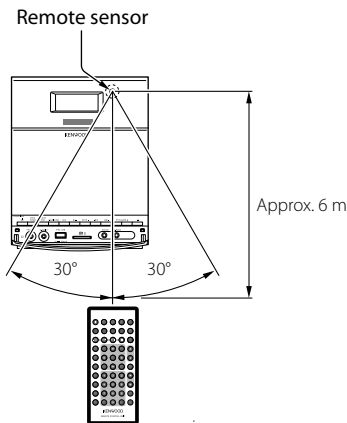

- The supplied battery may have shorter live than ordinary battery due to use during operation checks.
- When the remote-controllable distance gets shorter than before, replace the battery with a new one.
- Placing the remote sensor in direct sunlight, or in direct light from a high frequency fluorescent lamp may cause a malfunction.  
In such a case, change the location of the system installation to prevent malfunction.

## Changing the battery of the remote control unit

Use a commercially available button battery (CR2025).

- 1 Insert something narrow like a paperclip into the hole and pull out the battery tray.

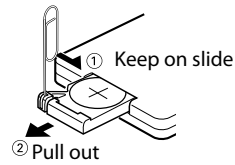

- 2 Replace the old battery with a new one.

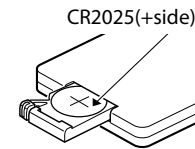

### CAUTION

- Lithium battery.  
Danger of explosion if the battery is incorrectly replaced. Replace only with the same or equivalent type.
- The battery pack or batteries shall not be exposed to excessive heat such as sunshine, fire or the like.
- Keep battery out of reach of children and in original package until ready to use. Dispose of used batteries promptly. If swallowed contact physician immediately.

## Connections

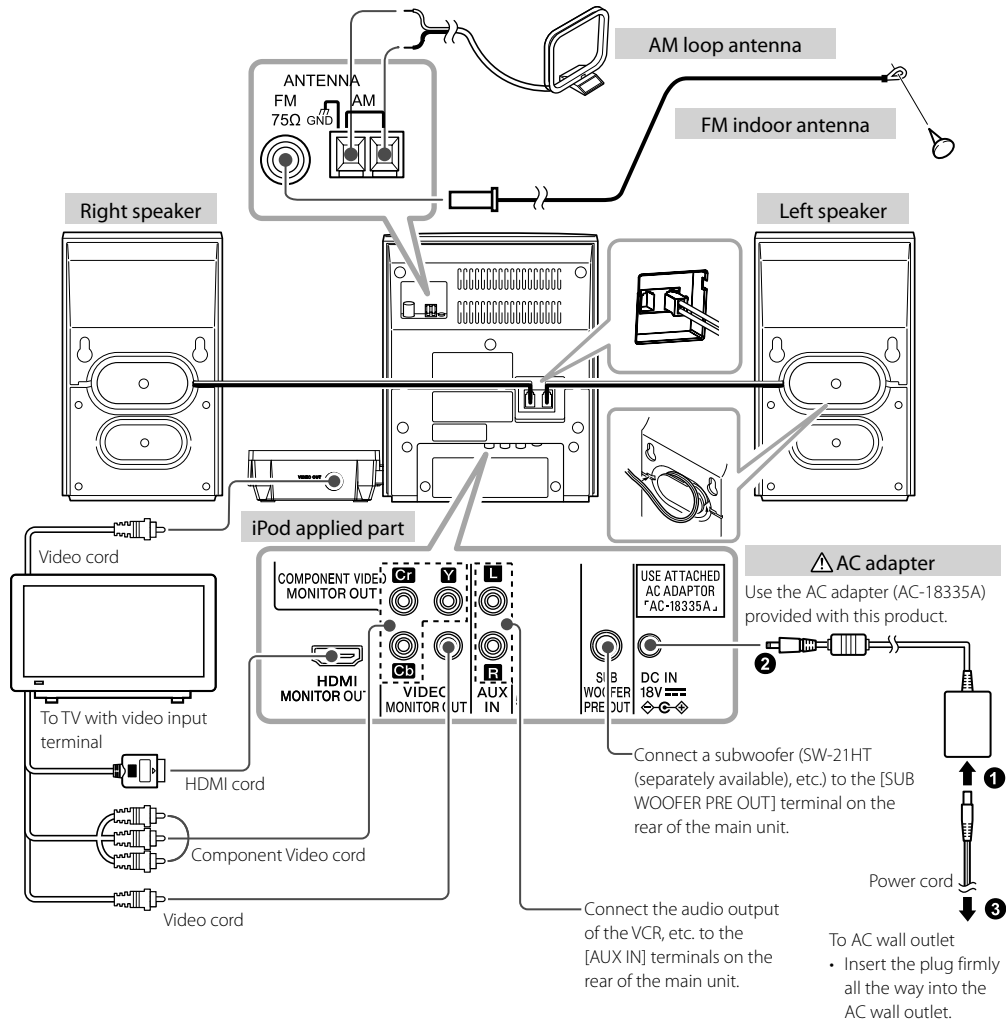

### **CAUTION**

The power in this equipment will not be completely cut off from the wall outlet when the standby switch is turned off. Install the equipment so that the wall outlet is easily accessible and, in case of emergency, immediately unplug the power plug from the wall outlet. Mains plug is used as the disconnect device, It shall remain readily operable and should not be obstructed during intended use.

### **CAUTION**

**Be sure to adhere to the following, or proper ventilation will be blocked causing damage or fire hazard (Main unit and AC adapter).**

- Do not place a cloth on the system or place it on a carpet or cushion.
- Do not use the system in a poorly ventilated place.
- Do not place any objects impairing heat radiation onto the top of the unit.
- Leave some space around the unit (from the largest outside dimension including projection) equal to or greater than, shown below.

**Top panel : 50 cm**

**6** C-717DV

### Connecting the FM antenna

- 1 Connect the lead to the [FM 75Ω] terminal.
- 2 Find the location that gives the best reception.
- 3 Secure the antenna as high up as possible.

- The antenna supplied with the system is a basic antenna for indoor use. For stable signal reception, the use of an outdoor antenna (commercially available) is recommended. Disconnect the indoor antenna first before connecting an outdoor antenna.



### ⚠ CAUTION on installing an outdoor antenna

- Since antenna installation necessitates skill and experience, always consult your dealer before installation. The antenna should be placed at a distance from the power distribution wires. Otherwise, an electric shock accident may occur if the antenna falls down.

### Connecting the AM antenna

- 1 Connect the AM antenna cord to the [AM] and [GND] terminals.

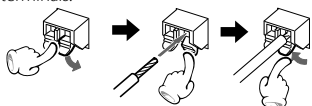

- 2 Setup the antenna in the position and the direction to be able to receive AM broadcast.

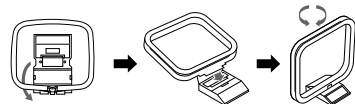

- The antenna supplied with the system is for indoor use. Place it as far away as possible from the system, your TV set, the speaker cords, AC adapter and the power cord, and point it in the direction that provides the best reception.

### Connecting the iPod applied part

- 1 Connect the iPod applied part to iPod applied part connector

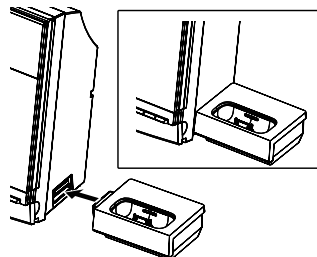

- 2 Insert the Dock adapter into 3 Connect your iPod/iPhone. unit.

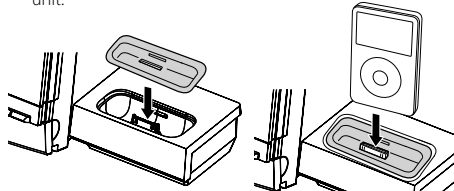

### To remove Dock adapter

- Insert a thin object such as the tip of a flat-blade screwdriver into the slit on the dock adapter and lift it to remove.

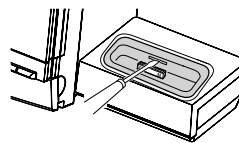

- Connect an iPod dock adapter, which is provided with your iPod/iPhone or commercially available in iPod dealers, to the iPod dock of this unit. Note that the iPod adapter is not provided with this unit.
- See page 9 for the supported iPod/iPhone models.

### Connecting the HDMI terminal

- 1 When you use HDMI connection, you can change the resolution (576p, 720p, 1080i, 1080p) for the HDMI output. (See page 20)

The HDMI will be outputted at 576p resolution, even if you set the resolution to 576i on the HDMI connection.

- When the no sound or noisy sound are outputted with HDMI connection, set the HDMI AUDIO in DVD SETUP menu to PCM. (See page 21)
- If there is noise or lines on the screen, please check the HDMI cable.
- Not all HDCP-compatible DVI devices will work with this unit.
- If your HDMI TV does not support HDCP, the blue screen appears on the screen.
- If the abnormal picture appears on the TV screen, turn off the unit and then turn the unit on again.

## Disc information

### Types of Playable Discs

The system this unit is using does not only play music from CD but can also play the discs listed below to offer you high-quality entertainment of video of movies and live concerts.

Playable Disc	DVD VIDEO (DVD-R/RW, DVD+R/RW)		CD (CD-R, CD-RW)		VCD (SVCD*)	
Logo mark on disc						
Disc size	 8 cm	 12 cm	 8 cm	 12 cm	 8 cm	 12 cm
Played sides	One or both	One or both	One side only	One side only	One side only	One side only
Contents	Video + Audio	Approx. 41 min. (1 side, 1 layer) Approx. 75 min. (1 side, 2 layers) Approx. 82 min. (2 sides, 1 layer) Approx. 150 min. (2 sides, 2 layers)	Approx. 133 min. (1 side, 1 layer) Approx. 242 min. (1 side, 2 layers) Approx. 266 min. (2 sides, 1 layer) Approx. 484 min. (2 sides, 2 layers)			Max. 20 min.      Max. 74 min.  (In case of an SVCD, the possible playback time becomes shorter.)
	Audio			Max. 20 min., digital	Max. 80 min., digital	

- \* This unit can play SVCDs, but some functions will not work.
- A Dual Disc is a two-sided disc combining a DVD side according to the DVD standard and a music side. The video content recorded on the DVD side can be played back. As the music side is not compatible with the Compact Disc (CD) standard, playback on this unit is not assured.
- This unit can play back DVD-R and DVD-RW discs recorded in the DVD VIDEO format and DVD+R and DVD+RW discs, but depending on the recording unit, the disc manufacturer, etc., playback sometimes may not be possible.
- This unit may also be incapable of playing certain CD-R/RW discs depending on their properties, recording conditions, etc.
- This player cannot play back discs compatible with CPRM. CPRM is the abbreviation of Content Protection for Recordable Media, and it is a technique for copyright protection for recording media.

### Unplayable discs

This player cannot play back any of the following discs.

DVD AUDIO discs, DVD-RAM discs, SACD discs, VSD discs, CDV discs (Only the audio part can be reproduced.), CD-G/CD-EG/CD-EXTRA discs (Only the audio can be reproduced.)

### Regional code

This unit has a regional code printed on the rear of the unit. This unit can play only DVD discs labeled same as the rear of the unit or "ALL".

- Most DVD discs have a globe with one or more numbers in it clearly visible on the cover. This number must match your unit's regional code or the disc cannot play.
- If you try to play a DVD with a different regional code from your unit, the message "WRONG REGION" appears on the TV screen.



## Operation regulatory marks

With this DVD, some functions of this unit such as the play function may be restricted depending on the location where the DVD is playing. In this case, the following marks will appear on the screen. For more information, refer to the disc manual.

"Invalidity key"

## Handling discs

### Handling precautions

Hold a disc taking care not to touch the played surface. (The side without the printed label is the playback side.)

### Notes on CD-ROM/CD-R/CD-RW discs

If the CD-ROM, CD-R or CD-RW disc in use has a printable label surface, the disc may be unable to be taken out of the system due to sticking of the label surface. To prevent malfunction of the system, do not use such a disc.

### Cautions on CD discs

Always use a CD carrying the  marking.

A disc without this marking may be unable to be played back correctly.

The disc rotates at a high speed during playback. Never use a cracked, chipped or greatly warped disc. Otherwise, damage or malfunction of the player may result.

Also, do not use a disc with a non-circular shape as this may result in malfunction.

## About USB device

### Notes on use of the USB device

This unit can play audio files stored in the flash memory and digital audio player that have a USB port (these devices are referred to as USB devices in this document).

The following restrictions are placed on the types and usage of available USB devices:

### Available USB devices

- USB devices belonging to the USB mass storage class.
- USB devices whose maximum current consumption is 500 mA or less.



- **USB Mass Storage Class** : USB devices that the PC can recognize as an external storage without using any special driver or application software.

- Contact the sales agent as to whether your USB device conforms to the USB mass storage class specs.
- Using an unsupported USB device can result in abnormal playback or display of the audio file.  
Even if you use the USB device conforming to the above specs, audio files cannot be played normally depending on the type or condition of the USB device.

## Supported iPod/iPhone

### Made for

- iPod nano (6th generation)
- iPod nano (5th generation)
- iPod nano (4th generation)
- iPod nano (3rd generation)
- iPod nano (2nd generation)
- iPod classic
- iPod touch (4th generation)
- iPod touch (3rd generation)
- iPod touch (2nd generation)
- iPod touch (1st generation)
- iPhone 4
- iPhone 3GS
- iPhone 3G
- iPhone



- Be sure to update the software of your iPod/iPhone to the latest version.
- The iPod/iPhone cannot be connected together with its accessories such as the cover or case. Be sure to remove any accessories before connecting the iPod/iPhone.
- Video output setting of iPod/iPhone needs to be set on your iPod/iPhone.
- When the iPod/iPhone is detached from the iPod dock, the TV Out setting of the iPod/iPhone may sometimes be set to On. Check this setting if the iPod/iPhone cannot display video.

## About MP3 and WMA

The playable MP3/WMA file (hereafter called **Audio file**) and the media format have the following limitation. The Audio file, which is not conforming to the specification, may not play normally.

### Playable Audio file

#### Playable MP3 file

- File formats: MPEG 1/2 Audio Layer 3 file
- Extension: .mp3
- Transfer bit rate: 8 kbps – 320 kbps
- Sampling frequency: 48/ 44.1/ 32/ 24/ 22.05/ 16/ 12/ 11.025/ 8 kHz

#### Playable WMA file

- File format: Windows Media™ Audio compliant
- Extension: .wma
- Transfer bit rate: 32 kbps – 320 kbps
- Sampling frequency: 48/ 44.1/ 32 kHz
- Files created using functions in Windows Media™ Player 9 or later cannot be played.
  - WMA Professional
  - WMA Lossless
  - WMA Voice



- Do not attach the extensions to files other than the Audio file. If the extension is attached, the file, which is not the Audio file, will play and outputs a loud noise, causing damage to the speaker.
- The files with copy protection cannot be played.
- Audio files cannot be played depending on the encoding software setting, USB device type, and/or recording conditions.
- The unit may not be compatible with upgrade of compression format standard and additional specifications.
- Audio files encoded using VBR (Variable Bit Rate) may use bit rates that fall outside the supported range. Audio files with bit rates outside the supported range cannot be played.

### Playable storage media

- DVD±R/RW, DVD-ROM, CD-ROM, CD-R, CD-RW
- USB device (USB version 1.1/2.0)
- SD, SDHC, mini SD, micro SD/SDHC card



- CD-RW discs which are quick formatted by the writing software cannot be used.
- When recording to the maximum CD-R/RW media capacity at once, the writing software is set to "Disc at once".
- For details on the available USB devices, refer to <About USB device> (page 9).
- For details on the available SD/SDHC card, refer to <About SD card> (page 11).

### Playable DVD±R/RW format

- UDF-Bridge

### Playable CD-R/RW format

- ISO 9660 Level 1/2
- Joliet

### Playable file system of USB device/ SD card

- FAT 16/ 32

### The maximum number of characters for display

- File/Folder name: 30/ 9 characters
- MP3 ID3 TAG/ WMA Contents property: 30 characters
  - WMA Contents property (album name): 14 characters(The information which can be displayed with this unit: title, artist name, and album name)



- File/Folder name is the number of the characters including the extensions.
- This unit can display the following versions of MP3 ID3 TAG: version 1.0/ 1.1/ 2.2/ 2.3/ 2.4
- A character that cannot be displayed with this unit is displayed incorrectly or substituted by "-".

### Limitation of structure for the file and the folder

- Maximum number of folders: 130 (including root folder)
- Maximum number of files per media: 999

### Playing order of the audio file

- Audio files are played in the order the files are written. You can specify the order of playback by numbering files in a folder and writing them by folder.

### Example

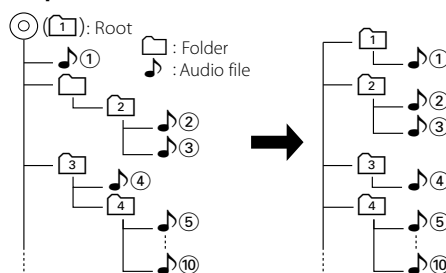

### Playing order

Playing order after 1 play:

➡ 2, 3, 4, 5...

## About Video file

### Acceptable video files

#### Playable MPEG1, MPEG2 file

- File formats: MPEG 1/2
- Extension: .mpg, .mpeg, .m1v, .m2v
- Picture size: 720 × 480, 720 × 576
- Profile & Level: MP@ML (Main Profile at Main Level)
- Audio format: MPEG Audio Layer 2/3
- Audio sampling frequencies: 32/ 44.1/ 48 kHz
- Audio bit rate: 32–384 kbps (Only constant bit rates)
- File size: Max. 4 G bytes

#### Playable DivX file

- File format: DivX
- Extension: .divx, .div, .avi
- Picture size: 352 × 240, 352 × 288, 720 × 480, 720 × 576
- Audio format: MP3, Dolby Digital
- Audio sampling frequencies: 32/ 44.1/ 48 kHz
- Audio bit rate: 32–384 kbps (Only constant bit rates)
- File size: Max. 4 G bytes

#### ABOUT DIVX VIDEO:

DivX® is a digital video format created by DivX, Inc. This is an official DivX Certified® device that plays DivX video. Visit [divx.com](http://divx.com) for more information and software tools to convert your files into DivX video.

#### ABOUT DIVX VIDEO-ON-DEMAND:

This DivX Certified® device must be registered in order to play purchased DivX Video-on-Demand (VOD) movies. To obtain your registration code, locate the DivX VOD section in your device setup menu. Go to [vod.divx.com](http://vod.divx.com) for more information on how to complete your registration.



- When buying DRM enabled contents, check the Registration Code in the <DIVX [R] VOD> (page 21). Registration Code changes each time a file with the displayed Registration Code is played to protect against copying.

## About Picture file

### Acceptable picture files

#### Playable JPEG file

- File formats: JPEG
- Extension: .jpg, .jpeg
- Baseline format: Up to a maximum of 8192(W) × 7680(H) pixels
- Progressive format: —
- File size: Max. 4 M bytes

## About SD card

### Available SD card

- SD, SDHC, mini SD, micro SD/SDHC card
- An SD card of 512 MB to 32 GB can be used.



- A special adapter is required for using a mini SD/micro SD card.
- A multimedia card (MMC) cannot be used.
- Data recorded in the SD audio format cannot be played back.
- This unit is capable of playback of SD/SDHC memory cards complying with the SD or SDHC standard.

## Usable D.AUDIO

To control a Kenwood digital audio player from the main unit or remote control unit, the Kenwood digital audio player connection cable is necessary.

#### Usable Kenwood digital audio player models

HDD audio player	Memory audio player/recorder
HD20GA7	MGR-E8/MGR-A7/M2GD55/ M1GD55/M1GC7/M2GC7

## Component names and functions

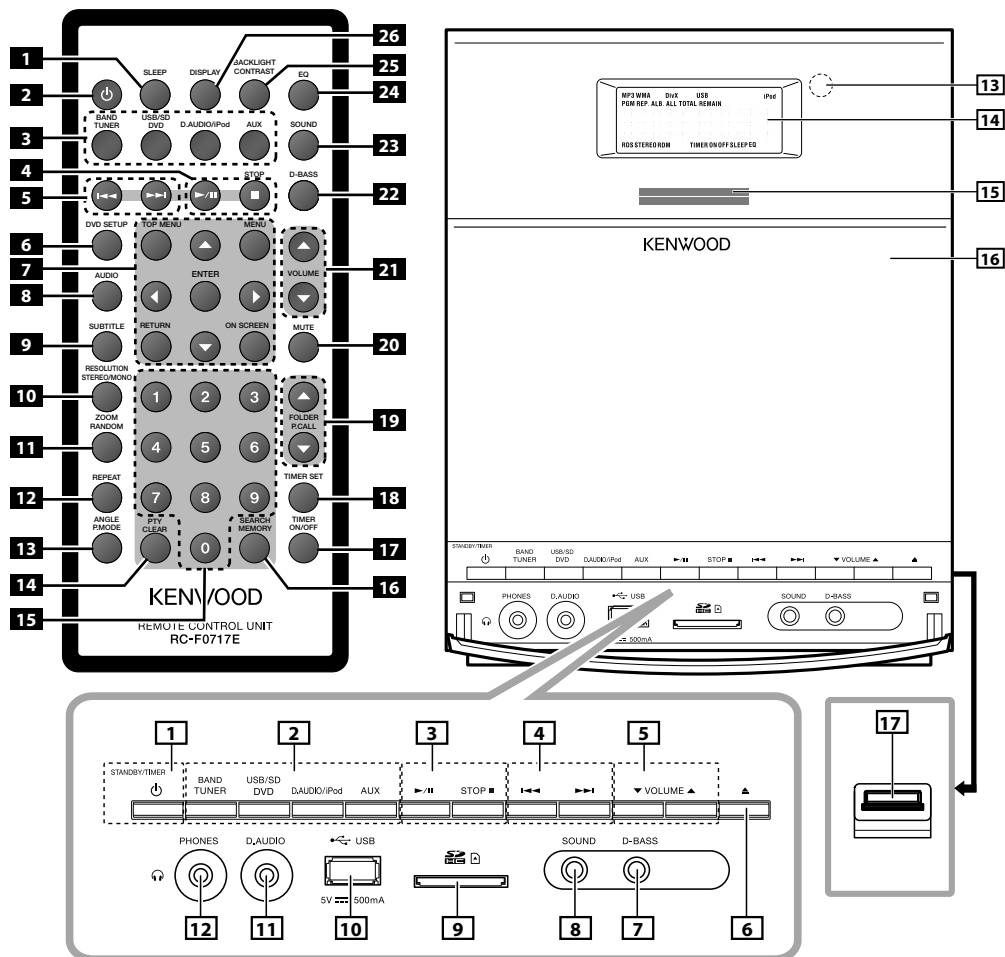

### 1 SLEEP button

To select the sleep time.

### 2 1 ⏻ button

To switch the system on or to standby mode.

### [STANDBY/TIMER] indicator

Red lighting: Ordinary standby mode

Orange lighting: Timer standby mode

### 3 2 Source buttons

To select the source you want, or to turn the system on to the selected source.

### TUNER BAND button

FM → AM

### DVD/USB/SD button

DVD → USB → SD

### D.AUDIO/iPod button

D.AUDIO → iPod

### AUX button

AUX

## 12 C-717DV

**4 3 ▶/|| button**

To start or interrupt playback for DVD, audio file, video file, iPod, iPhone and D.AUDIO.

**STOP ■ button**

To stop playback for DVD, audio file and video file.

**5 4 ◀◀ / ▶▶ buttons**

To search forward/backward to next/previous title/chapter/track for DVD.

To search forward/backward or to skip to the next/previous files for audio files and iPod, iPhone.

To tune to higher/lower radio frequency or search radio stations for TUNER.

**6 DVD SETUP button**

To access or remove setup menu.

**7 MULTI CONTROL ▲/ ▼/ ◀/ ▶ buttons**

To select a setting item.

**ENTER button**

To enter the selected item.

**RETURN button**

To Return on a Video CD with PBC.

**ON SCREEN button**

To access On-Screen Display.

**TOP MENU button**

To view the DVD top menu.

**MENU button**

To view the DVD menu.

**8 AUDIO button**

To select an audio language or an audio channel for DVD, Audio file or video file.

**9 SUBTITLE button**

During playback, this button repeatedly to select a desired subtitle language for DVD.

**10 RESOLUTION/ STEREO/MONO button**

Press to switch the resolution of the video output as a result of conversion of an analog video signal.

To switch between stereo mode and mono mode (on FM band only) for TUNER.

**11 ZOOM RANDOM button**

To playback in random order for CD, audio file.

To select the zoom ratio for DVD, Video CD.

**12 REPEAT button**

To repeat one track/file or all tracks/files for CD, audio file and iPod, iPhone.

**13 ANGLE P.MODE button**

To program tracks/files for CD and audio file.

To select a DVD camera angle for DVD.

**14 PTY/CLEAR button**

To carry out PTY search.

To delete the track/file number entered during track.

**15 digit 0 – 9 buttons**

To select a track/file number for CD and audio file.

To select a preset radio station for TUNER.

**16 SEARCH/MEMORY button**

To select a desired title/chapter/track/file or time with on screen bar.

To auto /manual preset radio stations for TUNER.

**17 TIMER ON/OFF button**

To switch the timer on/off.

**18 TIMER SET button**

To set the clock.

To set the timer.

To set the A.P.S.

**19 FOLDER/P.CALL ▲/ ▼ buttons**

To select an album (folder) of audio files and iPod, iPhone.

To select a preset radio station for TUNER.

**20 MUTE button**

To interrupt and resume sound reproduction.

**21 5 VOLUME ▲/ ▼ buttons**

To increase or decrease the volume.

**22 7 D-BASS button**

To switch bass enhancement.

**23 8 SOUND button**

To select the desired DTS Envelo Speaker for the 3D surround effect: DTS Envelo ON:1, ON:2 or OFF.

**24 EQ button**

To select the desired sound effect : POP, CLASSIC, ROCK, JAZZ, GAME or FLAT (off).

**25 BACKLIGHT/CONTRAST button**

To switch the display backlight and illumination on and off.

To adjust the display contrast.

**26 DISPLAY button**

To change the time display for CD.

To change the information display for audio files.

To change the display for Radio Data System.

To change the clock display for AUX, iPod, D.AUDIO.

**6 [▲] button**

To open or close the DVD door.

**9 SD card slot**

**10 USB connector**

**11 D.AUDIO input terminal**

**12 PHONES jack**

**13 Remote sensor**

**14 Display**

**15 Illumination**

**16 DVD door**

**17 iPod applied part connector**

**Standby mode**

While the STANDBY/TIMER indicator is lit, a small amount of power is supplied to the system to back up the memory. This is called standby mode. Under the condition, the system can be turned ON by the remote control unit.

## Basic function

### Switching the system on

Press **⏻**, **TUNER BAND**, **DVD/USB/SD**, **D.AUDIO/iPod**, **AUX** button.

The **[STANDBY/TIMER]** LED will go out.  
The system will switch to the last selected source or the selected source.

### Switching the system to standby mode

Press **⏻** button.

**[STANDBY/TIMER]** indicator is lit.

### Volume control

Press **VOLUME ▲** button to increase, or press **VOLUME ▼** to decrease the volume level.

"VOL XX" is displayed. Adjust in the range from 0 (MIN.) to 40 (MAX.).

### To switch off the volume temporarily

Press **MUTE** button.

Playback continues without sound, and "MUTE" is displayed.



- To restore the volume, press **MUTE** button again or adjust the volume.

### Sound control

The sound control system feature enables you to enjoy special sound effects; 3D surround effect, preset equalizer settings and bass enhancement, providing the best music reproduction.

### To switch on DTS Envelo Speaker settings

Press **SOUND** button to select DTS Envelo Speaker for the 3D surround effect: **DTS Envelo ON:1**, **ON:2** or **OFF**.

When an effect other than OFF is selected, the "DTS" appears on the display.

### To switch on preset equalizer settings

Press **EQ** button to select the desired sound effect: **POP**, **CLASSIC**, **ROCK**, **JAZZ**, **GAME** or **FLAT (off)**.

When an effect other than FLAT is selected, the icon "EQ" appears on the display.

### To switch on the bass enhancement

**For Remote control unit:**

Press **D-BASS** button. Press **MULTI CONTROL ▲** or **▼** button to adjust the enhancement level: **D-BASS 1 to 10** or **OFF** and press **ENTER** button.

**For Main unit:**

Press **D-BASS** button. Press **◀◀** or **▶▶** button to adjust the enhancement level: **D-BASS 1 to 10** or **OFF**.

The icon "EQ" appears on the display.



- Pressing **[D-BASS]** cancels the equalizer settings (EQ).
- Pressing **[EQ]** cancels the low frequency enhancement (D-BASS) and DTS Envelo Speaker effect (SOUND).
- The DTS Envelo Speaker effect is cancelled when headphones are connected.

### Headphones

To listen to your stereo with headphones (separately available), use the 3.5 mm phones jack on the main unit.

Connecting headphones mutes the sound from the speakers.

### ⚠ CAUTION

- Excessive sound pressure from earphones and headphones can cause hearing loss.

## Using the DVD/USB device/SD card

### Preparation

#### Inserting a disc

- 1 Press DVD/USB/SD button once or more to select "DVD".
- 2 Press ▲ button to open the DVD door.

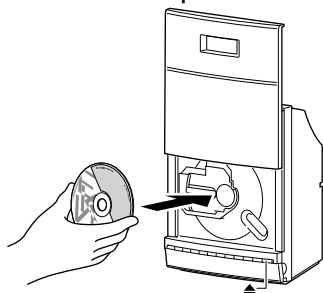

- 3 Insert a disc into the disc loader with the label side facing you.
- 4 Press ▲ button to close the DVD door.  
For a DVD, playback starts automatically.  
For a CD, the total playtime and total number of tracks will appear in the display.  
For an audio file-CD, the total album number and total file number will appear on the display.

#### Removing a disc

- 1 Press ▲ button and carefully pull it out.
- 2 Press ▲ button to close the DVD door.

#### Inserting a USB device

- 1 Press ⏻ button to select standby mode.
- 2 Insert a USB device to the USB connector on the front panel.

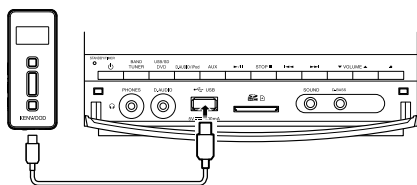

- 3 Press DVD/USB/SD button once or more to select "USB".  
"USB" is displayed. The total album number and total file number will appear on the display.

#### Removing the USB device

- 1 Press ⏻ button to select standby mode.
- 2 Remove the USB device.

#### Inserting an SD card

- 1 Press ⏻ button to select standby mode.
- 2 Insert the SD card into the SD card slot until it clicks.

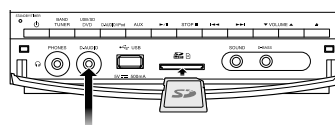

Insert the SD card so that the label side faces up and the side with a cut comes on the right.

- 3 Press DVD/USB/SD button once or more to select "SD".  
The total album number and total file number will appear on the display.

#### Removing the SD card

- 1 Press ⏻ button to select standby mode.
- 2 Remove the SD card.



- To ensure good system performance; wait until the unit completely reads the disc/USB device/SD card before proceeding.
- If the disc compartment is not loaded with a disc, "NO DISC" is displayed.
- If the disc is unreadable or there is no playable audio file in the USB device/SD card, "NO DATA" is displayed.
- For audio files, reading time may exceed 10 seconds due to the large number of songs compiled into one disc/ USB device/ SD card.
- The icon "MP3" appears only when an MP3-file is played. The icon "WMA" appears only when a WMA-file is played. The icon "DivX" appears only when a DivX-file is played.

## Using the DVD/USB device/SD card

### Playing a DVD/ Video CD

Press **▶/II** button to start playback.

The title/track number and elapsed playing time of the current title/track appear on the display.

#### Basic operations

Operation type	Operation
To stop playback	Press <b>STOP ■</b> button. When pressed twice, the disc is played from its beginning when you play it in the next time.
To interrupt playback	Press <b>▶/II</b> button. Press again to resume playback.
To select a chapter/track	Press <b>I◀◀</b> or <b>▶▶I</b> button in play or pause mode.
To search for a particular passage during playback	Press and hold <b>I◀◀</b> or <b>▶▶I</b> button for more than 2 seconds to select the searching speed, then release the button. "x2" → "x4" → "x8" → "x20" Press <b>▶/II</b> button at any time to resume normal playback.
Slow-motion playback *1	1. Press <b>▶/II</b> button to pause. 2. Press <b>MULTI CONTROL ◀</b> or <b>▶</b> button. "1/2" → "1/3" → "1/4" → "1/5" → "1/6" → "1/7" → "1/8"*2 → "PLAY" 3. Press <b>▶/II</b> button at any time to resume normal playback.
Forward frame-by-frame playback	1. Press <b>▶/II</b> button to pause. 2. Press <b>MULTI CONTROL ▲</b> button. 3. Press <b>▶/II</b> button at any time to resume normal playback.
To Select a subtitle language (For DVD only)	During playback, press <b>SUBTITLE</b> button repeatedly to select a desired subtitle language.
To Select an audio language (For DVD only)	During playback, press <b>AUDIO</b> button repeatedly to select a desired audio language.
To Select an audio channel (For Video CD only)	During playback, press <b>AUDIO</b> button. Each press switches the selection. MONO L → MONO R → STEREO → Mix MONO
To Select a camera angle (For DVD only)	During the angle indicator has blinked, press <b>ANGLE</b> button. Select the camera angle with press <b>ANGLE</b> button.

\*1 Slow motion playback in reverse is not possible with Video CDs.

\*2 Slow motion playback in reverse only.

### DVD disc menu

Operation type	Operation
To View the title menu	Press <b>TOP MENU</b> button to display the disc's title menu, if available.
To View the DVD menu	Press <b>MENU</b> button to display the disc menu, if available.
To select a menu item	Use the <b>MULTI CONTROL ▲/▼/◀/▶</b> button to highlight your selection, then Press <b>ENTER</b> button.

### Video CD PBC Menu

Operation type	Operation
To turn the PBC On or Off	Press <b>TOP MENU</b> button.
To select a menu item	Press the digit buttons 0-9, and then press <b>ENTER</b> button.
To return	Press <b>RETURN</b> button to return to the menu screen.

### Playing a CD/ audio file/ video file

Press **▶/II** button to start playback.

The track/file number and elapsed playing time of the current track/file appear on the display.

#### Basic operations

Operation type	Operation
To stop playback	Press <b>STOP ■</b> button. When pressed twice, the disc is played from its beginning when you play it in the next time.
To interrupt playback	Press <b>▶/II</b> button. Press again to resume playback.
To search for a particular passage during playback	Press and hold <b>I◀◀</b> or <b>▶▶I</b> button for more than 2 seconds to select the searching speed, then release the button. "x2" → "x4" → "x8" → "x20" Press <b>▶/II</b> button at any time to resume normal playback.
To select a track/ file	Press <b>I◀◀</b> or <b>▶▶I</b> button in play or pause mode.
To select a folder (For audio file/ video file only)	Press <b>FOLDER/P.CALL ▲</b> or <b>▼</b> button in play or pause mode.



- For audio file, video file; "F:xxx T:xxx" appears on the display. "F:xxx" indicates album number and "T:xxx" indicates the file number.



- The digit buttons, 0–9 on the remote control unit can also be used to select a track/file.  
Press the digit buttons as shown below:

	CD	Audio/ video file
To select track/file 2	2 and ENTER	2 and ENTER
To select track/file 23	2 and 3	2, 3 and ENTER
To select file 120	—	1, 2 and 0

If the **ENTER** button is not pressed, the search for the selected track/file will start in 5 seconds.

### Direct Search (For DVD, Video CD, CD, audio file only)

- Press **SEARCH/MEMORY** button.  
In case of Audio file or Video file, press this button during playback.
- Press **MULTI CONTROL ◀ or ▶** button to select an item.  
Example : DVD Video  

- Press the digit buttons 0-9 to input.
- Repeat step 2 and 3 to enter the time.
- Press **ENTER** button to confirm the start time.

### File Select (For audio file, video file, picture file only)

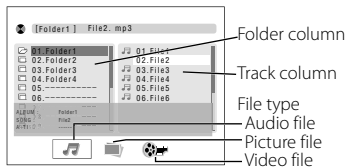
You can select a file from the list display.



- During playing of video file/ picture file, press **STOP ■** button to stop.  
The list display is remained during the playback of audio files.
- Press **MULTI CONTROL ◀ or ▶** button to select the Folder column, Track column, or File type.
- Press **ENTER** button.
- Press **MULTI CONTROL ▲ or ▼** button to select a folder or track.
- Press **ENTER** button to the start playback.

### For picture file

Operation type	Operation
To start slide show	Press <b>▶/  </b> button.
To stop playback	Press <b>STOP ■</b> button.
To interrupt playback	Press <b>▶/  </b> button.
To select a file	Press <b>◀◀</b> or <b>▶▶</b> button.
To full screen view	Press <b>ENTER</b> button.
To rotate picture	Press <b>MULTI CONTROL ◀</b> or <b>▶</b> button.
To flip vertical	Press <b>MULTI CONTROL ▲</b> button.
To flip horizontal	Press <b>MULTI CONTROL ▼</b> button.



- When selecting a picture file, the preview appears in the folder column.

## Programming chapters/tracks/files

Programming chapters/tracks/files of a DVD/ audio file/ video file is possible when playback is stopped. Up to 32 tracks can be stored in the memory in any order.

### 1 In stop mode, press P.MODE button to enter program setting.

The icon "PGM" and "P-01 T- --" appears on the display.

"T- C- --" indicates track number of the DVD.  
 "T- --" indicates track number of the CD/ Video CD [PBC off].  
 "T- -- o" indicates file number of the audio file/ video file/ picture file.  
 "P-01" indicates program number.  
 The icon "PGM" starts flashing.

### 2 Press MULTI CONTROL ▲ or ▼ button, or digit buttons 0-9 to select the desired title/track/file.

For DVD: Press ENTER button, and then press MULTI CONTROL ▲ or ▼ button, or digit buttons 0-9 to select the desired chapter.

### 3 Press ENTER button to store the selected chapter/track/file.

The track/file number returns to "T- --"/ "T- -- o" and the next program number appears on the display.

### 4 Repeat steps 2 to 3 to select and store other desired chapters/tracks/files in this way.

The icon "PGM" appears on the display.

### 5 Press ►/II button to play the programmed chapters/tracks/files.



- "PGM FULL" appears on the display, if you attempt to program more than 32 tracks/files.
- Audio files can only be programmed within the same source.
- Now enter the new track/file number with either method below.
  - Press **CLEAR** button to clear the chapter/track/file number programmed. Select the new chapter/track/file number using digit buttons "0" to "9" on the remote control unit.
- If you press **REPEAT** button during programmed playback, the current track or all programmed tracks/files is/are played repeatedly.  
 The icon "REP" or "REP. ALL" and the icon "PGM" appear on the display.

### To clear the program

Press P.MODE button.

The icon "PGM" disappears from the display.



- "P" represents PROGRAM.
- The program is automatically cleared as soon as the DVD door is opened.
- The function of program setting cannot be used in PLAY/ PAUSE mode.

## Random play (except picture file)

You can play all the tracks/files in random order.

### 1 During playing, pause or stop mode, press RANDOM button to enable random play mode.

The icon "RDM" appears on the display.

### 2 To exit random mode, press RANDOM button again.

The icon "RDM" disappears from the display.

## Repeat play

You can play the current track/file/album or the whole disc/audio file repeatedly.

Press **REPEAT** button in play or pause mode.

Every time the button is pressed, the repeat play changes in the following order:

### For DVD Video :

Repeat mode	Icon/ Display
Repeat a chapter	"REP"/ "CHAPTER"
Repeat a title	"REP"/ "TITLE"
Repeat all	"REP. ALL"/ "REP ALL"
Repeat off	—/ "OFF"

### For CD/ Video CD [PBC off] :

Repeat mode	Icon/ Display
Repeat a single track	"REP"/ "REP 1"
Repeat all the tracks *1	"REP. ALL"/ "REP ALL"
Repeat off	—/ "OFF"

### For audio file/ video file/ picture file :

Repeat mode	Icon/ Display
Repeat a single file	"REP"/ "REP 1"
Repeat one album *2	"REP. ALB."
Repeat all the files *1	"REP. ALL"/ "REP ALL"
Repeat off	—



- \*1 All tracks/files are repeated continuously.
- \*2 This function cannot be used in program mode.

## Zoom

The zoom function allows you to enlarge the video image.

- 1 Press ZOOM button repeatedly during playback or in the pause mode to enlarge the image.

"OFF" → "2" → "3" → "4" → "1/2"\*1 → "1/3"\*1 → "1/4"\*1 → ...

- 2 You can move through the zoomed picture using MULTI CONTROL ▲/▼/◀/▶.

- 3 To cancel Zoom, press ZOOM button repeatedly until "ZOOM OFF" appears on the TV.



- \*1 You cannot move the zoomed-in position when "1/2", "1/3", or "1/4" is selected.

## Changing the display information

### To display the on-screen bar

Press ON SCREEN button.

Every time the button is pressed, the display changes in the following order:

#### For DVD :

Information	Icon/ Display
The current title elapsed time.	—/ "C"
Disc information	—
The current title remaining time.	"REMAIN"/ "C -"
The whole disc elapsed time.	"TOTAL"/ "T"
The whole disc remaining time.	"TOTAL REMAIN"/ "T -"
On-screen is clear	—/ —

#### For CD/ Video CD :

Information	Icon/ Display
The current track elapsed time.	—/ "C"
The current track remaining time.	"REMAIN"/ "C -"
The whole disc elapsed time.	"TOTAL"/ "T"
The whole disc remaining time.	"TOTAL REMAIN"/ "T -"
On-screen is clear	—/ —

#### For audio file/ video file :

Information	Icon/ Display
The current file elapsed time.	—/ "C"
The current file remaining time.	"REMAIN"/ "C -"
On-screen is clear	—/ —

#### For picture file :

Information	Icon/ Display
The file number	—/ "C"
On-screen is clear	—/ —

### To display the main unit

Press DISPLAY button in play or pause mode.

Every time the button is pressed, the display changes in the following order:

#### For audio file :

Information	Icon
Status display	—
Album name and file name.	—
TAG information (Track, album title and artist name).	—
Album number and track number.	—

## DVD Setup

### Switching the video resolution

Press to select the resolution of the video output as a result of video signal conversion.

Press RESOLUTION/ STEREO/MONO button.

Display	"576i"	"576P"	"1080i"	"720P"	"1080P"
Setting	720 x 576i	720 x 576p	1920 x 1080i	1280 x 720p	1920 x 1080p
HDMI	✓	✓	✓	✓	✓
Component video	✓	✓	✓	✓	✓
Composite video	✓	—	—	—	—



- If your TV does not accept your resolution setting, abnormal picture appears on the screen. Please read TV's owner's manual then set the resolution that your TV can accept.
- For 1080i, 720p and 1080p resolution on the component video out, only non-copy protected discs can be played back. If the disc is copy protected, it will be displayed at the 576p resolution without HDMI cable connection.

### Adjust the settings

**1** Press DVD/USB/SD button to select the DVD, USB, or SD source.

**2** In stop mode, press DVD SETUP button.

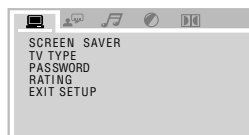



**3** Press MULTI CONTROL ◀ or ▶ button to select the menu.

**4** Press MULTI CONTROL ▲ or ▼ button to move to select the item.

**5** Press ENTER button.

**6** Press MULTI CONTROL ▲ or ▼ button to select the options, and then Press ENTER button.

Menu Item	Contents
SCREEN SAVER	You can set the screen saver function ( <b>ON</b> or <b>OFF</b> ). If no operation is done for about 3 minutes, starts the screen saver.
TV TYPE	<p><b>4:3 PS</b> (Pan Scan conversion): Select when a standard 4:3 TV is connected. Automatically displays the wide picture on the entire screen and cuts off the portions that do not fit.</p> <p><b>4:3 LB</b> (Letter Box conversion): Select when a standard 4:3 TV is connected. Displays a wide picture with bands on the upper and lower portions of the screen.</p> <p><b>16:9</b> (Wide-screen television): Select when a 16:9 wide TV is connected.</p>
PASSWORD	<p>You can prohibit operations used for changing the RATING setup. Enter a 4 digit password. We recommend that you write your password here for your reminder.</p> <p>Password: If you forget your password, you can release it by entering 0000.</p>
RATING	You can set playable rating level with the System.
EXIT SETUP	Exit DVD SETUP mode

OSD LANGUAGE	You can select the language displayed on the screen. <b>ENGLISH, GERMAN, SPANISH, FRENCH, ITALIAN, DUTCH</b>
AUDIO LANG	You can select the initial audio language for DVD Video. <b>ENGLISH, GERMAN, SPANISH, FRENCH, ITALIAN, DUTCH</b>
SUBTITLE LANG	You can select the initial subtitle language for DVD Video. <b>ENGLISH, GERMAN, SPANISH, FRENCH, ITALIAN, DUTCH</b>
 MENU LANG	You can select the initial menu language for DVD Video. <b>ENGLISH, GERMAN, SPANISH, FRENCH, ITALIAN, DUTCH</b>
DIVX [R] VOD	The System has its own Registration Code. If necessary, you can confirm it. Once you have played back a DivX file in which the Registration Code is recorded, the System's Registration Code is overwritten for copyright protection.
HDMI AUDIO	You can select the audio signal type emitted from the HDMI MONITOR OUT terminal. <b>AUTO:</b> Normally select this. The System automatically emits the appropriate audio signal according to the TV connected to the HDMI MONITOR OUT terminal. <b>PCM:</b> Select this if no sound is reproduced on the TV with the "AUTO" setting. The system converts the audio signal into PCM and emits the signal from the HDMI MONITOR terminal.
BRIGHTNESS	You can adjust the brightness. (0 to 12)
 CONTRAST	You can adjust the contrast. (0 to 12)
HUE	You can adjust the hue. (-6 to +6)
SATURATION	You can adjust the color depth. (0 to 12)
SHARPNESS	You can adjust the sharpness. (0 to 8)

DYNAMIC RANGE	You can select the Dynamic Range Compression (DRC) for night-time listening. DRC reduces the difference between normal voices and the sound (such as the sound of explosion). The effect of DRC is as follows. <b>FULL &gt; 6/8 &gt; 4/8 &gt; 2/8 &gt; OFF</b> When "OFF" is selected, the effect is not available.
 DUAL MONO	You can select the playback sound (channel) you want to while playing digital software recorded (or broadcasts) in Dual Mono mode, which includes two monaural channels separately. <b>STEREO, MONO L, MONO R, MIX MONO</b>
DOWNMIX	<b>LT/RT:</b> Outputs the sound mixed to the Dolby Surround audio. <b>STEREO:</b> Outputs the sound mixed to the stereo sound.

## Using the iPod/iPhone

### Inserting an iPod/iPhone

- 1 Connect a iPod/iPhone to the iPod applied part.
- 2 Press D.AUDIO/iPod button once or more to select "iPod".  
The icon "iPod" appears on the display.

### Playing an iPod/iPhone

Press ►/II button to start playback.

#### Basic operations

Operation type	Operation
Call to iPod/iPhone menu display	Press ◀ button. Call to iPod/iPhone menu display. Press to ▲ or ▼ button enter the selected iPod/iPhone menu item and press ENTER button..
To interrupt playback	Press ►/II button. Press again to resume playback.
To search for a particular passage during playback	Press and hold ◀◀ or ▶▶ button. Release to resume the playback.
To select a song	Press I◀◀ or ▶▶I button.
To select a album *1	Press FOLDER/P.CALL ▲ or ▼ button.



- \*1 The operation varies depending on the model of iPod/iPhone.

Model other than iPod touch/iPhone	iPod touch/iPhone								
The operation is available when one of the following items is selected.	The album is switched to the next album found by following the alphabetical order of track names.								
<table border="1"> <thead> <tr> <th>Browse item</th> <th>Selection</th> </tr> </thead> <tbody> <tr> <td>Artists, Composers</td> <td>All Albums</td> </tr> <tr> <td>Albums, Compilations</td> <td>All Songs</td> </tr> <tr> <td>Genres</td> <td>All Artists</td> </tr> </tbody> </table>	Browse item	Selection	Artists, Composers	All Albums	Albums, Compilations	All Songs	Genres	All Artists	– Example Track-A1 ..... Album-A Track-B1 ..... Album-B Track-B2 ..... Album-B Track-C1 ..... Album-C
Browse item	Selection								
Artists, Composers	All Albums								
Albums, Compilations	All Songs								
Genres	All Artists								

### Repeat play

You can play the current song or the all songs repeatedly.

Press REPEAT button.

Each press switches the selection of iPod/iPhone play mode.

### Random play

You can play all the album in random order.

Press RANDOM button.

Each press switches the selection of iPod/iPhone play mode.



- The displayed icon may not match the actual operation with certain iPod/iPhone models.

## Using the D.AUDIO

### Playback of Digital Audio Player

Kenwood digital audio player can be connected to play audio files in it.

#### 1 Connect an the player.

Connect a Kenwood digital audio player to the [D.AUDIO] connector using an optional cable or adapter. Also read the instruction manual for the connected component.

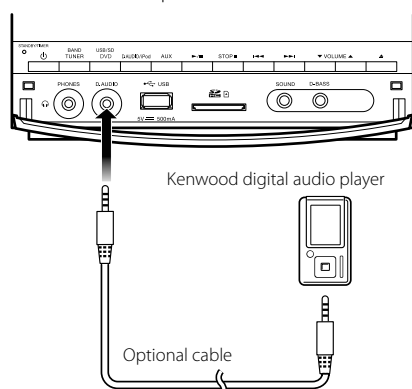

#### 2 Press D.AUDIO/iPod button once or more to select "D.AUDIO".

#### 3 Turn the connected player ON and start playing it.

### Basic operations

Operation type	Operation
To stop playback	Press <b>STOP</b> ■ button.
To interrupt playback	Press <b>▶/  </b> button. Press again to resume playback.
To search for a particular passage during playback	Press and hold <b>◀◀</b> or <b>▶▶</b> button for more than 2 seconds.
To select a track/ file	Press <b>◀◀</b> or <b>▶▶</b> button in play or pause mode.
To select a folder	Press <b>FOLDER/P.CALL</b> ▲ or ▼ button in play or pause mode.



- Some control operations may be unavailable depending on the connected player.

## Using the AUX

### Playing an external component

An external component can be connected to AUX IN of this unit and played back.

#### 1 Connect an external component.

Connect an external component to the [AUX IN] connector on the rear of this unit.

#### 2 Press AUX button.

#### 3 Start playing the connected external component.

## Using the radio

### Tuning in radio stations

- 1 Press **TUNER BAND** button to select the desired waveband: FM or AM.
- 2 Press and hold **◀◀** or **▶▶** button to tune in to the desired frequency.



- To tune to a weak station, briefly press **◀◀** or **▶▶** button repeatedly until the display shows the desired frequency or when the best reception has been obtained.

### STEREO/MONO

Press **RESOLUTION/ STEREO/MONO** button to select mono or stereo mode.

When stereo mode is selected, the icon "STEREO" appears on the display (if current station is FM stereo).



- You are able to select stereo or mono mode in FM band only.

### Auto preset

Radio stations can be preset automatically in preset channels.

- 1 Press **TUNER BAND** button to select the desired waveband: FM or AM.
- 2 Press **SEARCH/MEMORY** button for more than 2 seconds.

The receivable radio stations are preset automatically.

When the Auto preset operation has completed, the unit enters the condition in which preset station P01 is tuned.

### Manual preset

You can store up to 30 for FM and 10 for AM radio stations in the memory. When a preset radio stations selected, the preset number appears on the display.

- 1 Press **TUNER BAND** button to select the desired waveband: FM or AM.
- 2 Press **◀◀** or **▶▶** button to tune in to the desired frequency.
- 3 Press **SEARCH/MEMORY** button so that "P – –" appears on the display.
- 4 If you want to store the radio station to another preset number, press **FOLDER/P.CALL ▲** or **▼**, or digit buttons 0–9 to select the desired preset number.
- 5 Press **ENTER** button again to store the radio station.
- 6 Repeat steps 2 to 5 to store other preset radio stations.



- During preset, if no button is pressed within 20 seconds, the system will exit preset mode automatically.

### Tuning to a preset radio station

Press **FOLDER/P.CALL ▲** or **▼**, or digit buttons 0–9 to select the desired preset number.

The preset number and radio frequency appear on the display.



- Press the digit buttons as shown below:

To select 1	<b>1</b> and <b>ENTER</b>
To select 2	<b>2</b> and <b>ENTER</b>
To select 10	<b>1, 0</b> and <b>ENTER</b>



## Using Radio Data System

Radio Data System is a system that transmits useful information (in the form of digital data) for FM broadcasts along with the broadcast signal. Tuners and receivers designed for Radio Data System reception can extract the information from the broadcast signal for use with various functions, such as automatic display of the station name.

### Radio Data System functions

#### PTY (Program TYPe Identification) Search:

Automatically tunes to a station that is currently broadcasting the specified program type (genre).

#### PS (Program Service Name) Display:

Automatically displays the station name transmitted by the Radio Data System station.

#### Radio Text function:

Displays the radio text data transmitted by some Radio Data System stations when you press the **DISPLAY** button. There is "NO TEXT" display if no text data is transmitted.



- Some functions and function names may differ in certain countries and areas.

## Changing the Radio Data System display information

While receiving a Radio Data System station, pressing the **DISPLAY** button changes the contents of the display.

Every time the button is pressed, the display changes in the following order:

#### Information

PS (Program Service name) display

PTY (Program TYPe) display

RT (Radio Text) display

Frequency display and preset number display

## Tuning by Program Type (PTY search)

This function lets you set the tuner to automatically search for stations which are currently broadcasting the type of program (genre) you want to listen to.

**1 Press TUNER BAND button to select FM.**

**2 Press PTY button.**

If the current station is with Radio Data System, the program type of the station is displayed.

**3 Press FOLDER/P.CALL ▲ or ▼ button to select your desired program type.**

## Program type table

Program Type Name	Display
News	"NEWS"
Current Affairs	"AFFAIRS"
Information	"INFO"
Sport	"SPORT"
Education	"EDUCATE"
Drama	"DRAMA"
Culture	"CULTURE"
Science	"SCIENCE"
Varied Speech	"VARIED"
Pop Music	"POP M"
Rock Music	"ROCK M"
Easy Music	"EASY M"
Light Classical Music	"LIGHT M"
Serious Classical Music	"CLASSICS"
Other Music	"OTHER M"
Weather	"WEATHER"
Finance	"FINANCE"
Children's Program	"CHILDREN"
Social Affairs	"SOCIAL"
Religion	"RELIGION"
Phone In	"PHONE IN"
Travel	"TRAVEL"
Leisure	"LEISURE"
Jazz Music	"JAZZ"
Country Music	"COUNTRY"
National Music	"NATION M"
Oldies Music	"OLDIES"
Folk Music	"FOLK M"
Documentary	"DOCUMENT"

**4 Press PTY button to start searching.**



- Under certain receiving conditions, it may take more than 1 minute to complete the search.
- If the desired program type cannot be found, "NO PROGRAM" is displayed, then after several seconds the display returns to the original display.

## Clock/timer operation

### Clock setting

- 1 Press **TIMER SET** button.
- 2 Press **MULTI CONTROL ◀ or ▶** button to select **"CLOCK"** and press **ENTER** button.  
"CLOCK SETTING" appears on the display.
- 3 Press **ENTER** button.  
The hour indication starts flashing.
- 4 Press **MULTI CONTROL ▲ or ▼** button to set the hours and press **ENTER** button.  
The minute indication starts flashing.
- 5 Press **MULTI CONTROL ▲ or ▼** button to set the minutes and press **ENTER** button.  
When the setting completes, "COMPLETE" is displayed and the unit exits the setup mode automatically.



- The clock setting will be erased when the power cord is disconnected or a power failure occurred.
- The **MULTI CONTROL ◀ or ▶** button can be used to move across the setting items.

### Timer setting

The system can switch on to DVD, USB, SD, TUNER or iPod automatically at a preset time, serving as an alarm to wake you up.

#### **Important!**

**Before setting the timer, ensure that the clock is set correctly.**

- 1 Press **TIMER SET** button.
- 2 Press **MULTI CONTROL ◀ or ▶** button to select **"TIMER"** and press **ENTER** button.
- 3 **Set the time to start playback.**  
The icon "ON" starts flashing.  
Press **MULTI CONTROL ▲ or ▼** button to set timer start hours and press **ENTER** button to store the setting. Repeat the same procedure to set the minutes.  
The icon "OFF" starts flashing.
- 4 **Repeat the step 3 to set the time to stop the timer (off time).**  
The icon "TIMER" flashes and the source display appears.
- 5 **Press MULTI CONTROL ▲ or ▼ button to select the desired source and press ENTER button to store the setting.**  
The source switches as follows :  
"DVD" → "USB" → "SD" → "TU FM" → "TU AM"  
→ "iPod" → ...  
When a radio source (FM/AM) is selected, select the preset station number after the above.
- 6 **Press MULTI CONTROL ▲ or ▼ button to set volume level and press ENTER button to store the setting.**
- 7 **Press MULTI CONTROL ◀ or ▶ button to select the play mode and press ENTER button to store the setting.**

Play mode	Function
PLAY	The playback begins at the level set with VOLUME.
AI PLAY	The volume is increased gradually until the level set with VOLUME.

When the setting completes, "COMPLETE" is displayed and the unit exits the setup mode automatically.

The icon "TIMER" appears on the display.  
The timer is now set.

## 8 Switch the system to standby mode.

The STANDBY/TIMER indicator also lights in orange.



- When reached the preset timer, the selected source will play or switch to standby mode after the timer has been activated.
- The **MULTI CONTROL** ◀ or ▶ button can be used to move across the setting items.

### To activate/deactivate the timer

Press **TIMER ON/OFF** button.

If activated, the icon "TIMER" appears on the display.



- The timer off will not be activated if the starting and stopping time are the same.

### Sleep timer setting

If the sleep timer is activated, the system will switch to standby mode after the selected time has expired.

**Each press of the SLEEP button decreases the timer period by 10 minutes. The sleep timer can be set up to 90 minutes.**

The icon "SLEEP" appears on the display.

The display will change to sleep time display and change as follows:  
90 min → 80 min → 70 min → 60 min → 50 min  
→ 40 min → 30 min → 20 min → 10 min → OFF  
→ ...

#### While sleep timer is in active:

#### To deactivate the sleep timer

Press **SLEEP** button or press button to turn the power off.



- If timer off and the sleep off are all activated, the system will switch to standby mode by the earlier timer set.

## System setup

### Adjusting the display brightness (BACKLIGHT)

The brightness of the display backlight can be adjusted and how the display backlight and illuminations of this unit are lit can be selected.

- 1 Press **BACKLIGHT/CONTRAST** button.
- 2 Press **MULTI CONTROL** ◀ or ▶ button to select "BACKLIGHT" and press **ENTER** button.
- 3 Press **MULTI CONTROL** ▲ or ▼ button to select the backlight setting and press **ENTER** button to store the setting.

Setting	Function
BACKLIGHT: 1	Both the display backlight and illuminations are turned on.
BACKLIGHT: 2	The display backlight is turned on and the illuminations are turned off.
BACKLIGHT: 3	The display backlight is turned off and the illuminations are turned on.
BACKLIGHT: 4	Both the display backlight and illuminations are turned off.

When the setting completes, "COMPLETE" is displayed and the unit exits the setup mode automatically.

### Adjusting the display contrast (CONTRAST)

The contrast of the display can be adjusted.

- 1 Press **BACKLIGHT/CONTRAST** button.
- 2 Press **MULTI CONTROL** ◀ or ▶ button to select "CONTRAST" and press **ENTER** button.
- 3 Press **MULTI CONTROL** ▲ or ▼ button to adjust the contrast setting and press **ENTER** button to store the setting.

Setting	Function
1 □	Decreases the contrast.
2 □□	
3 □□□	
4 □□□□	
5 □□□□□	Increases the contrast.

When the setting completes, "COMPLETE" is displayed and the unit exits the setup mode automatically.

Continued to next page

English **27**

## System setup

### Setting Auto Power Save (A.P.S.)

A.P.S. stands for Auto Power Save, which is the function that switches this unit OFF when it has not been controlled for more than 30 minutes while its power is ON and the DVD and other inputs are in stop mode.

- 1 Press **TIMER SET** button.
- 2 Press **MULTI CONTROL** ◀ or ▶ button to select "A.P.S." and press **ENTER** button.
- 3 Press **MULTI CONTROL** ◀ or ▶ button to select the **A.P.S. setting** and press **ENTER** button to store the setting.

Setting	Function
A.P.S. ON	A.P.S. mode is ON.
A.P.S. OFF	A.P.S. mode is OFF.

When the setting completes, "COMPLETE" is displayed and the unit exits the setup mode automatically.

#### When the A.P.S. is ON...

A.P.S. is activated when this unit is in either condition below.

- When the input source is TUNER, AUX, D.AUDIO, or iPod, the volume level is 0 and no button has been pressed for 30 minutes.
- When the input source is DVD, USB or SD, the DVD player or USB device or SD is in stop mode and no button has been pressed for 30 minutes.



- When the A.P.S. is activated, the display shows flashing "A.P.S." from about one minute before this unit is switched OFF.

## In case of difficulty

### Resetting the Microcomputer

The microcomputer may malfunction (unit cannot be operated, or shows an erroneous display) if the power cord is unplugged while the power is ON, or due to some other external factor. If this happens, execute the following procedure to reset the microcomputer and return the unit to its normal operating condition.

**When the "NO DISC" mode (DVD source without a disc in the unit), press the [SOUND] button on the main unit until "FACTORY RESET" appears.**

**Unplug the AC cord and plug it back in if "RESET FINISHED" appears.**

- Please note that resetting the microcomputer will clear the contents of the memory and return the unit to the state it was in when it left the factory.

Check that following guide for problem resolution.

### General

#### No sound.

- ➔ Plug in AC cord securely.
- ➔ Set the VOLUME control to proper sound level.
- ➔ Make sure the source is set to the source you want to operate.
- ➔ Pull out the headphones plug from the headphones jack.

#### The left and right sound outputs are reverse.

- ➔ Check the speaker connections and location.

#### The system does not operate by pressing any buttons.

- ➔ Unplug the AC cord and plug it back in.

#### This unit is turned OFF spontaneously.

- ➔ A.P.S. is set to ON. Set it to OFF.

### Radio reception

#### Noise in radio.

- ➔ Tune to a correct frequency.
- ➔ Adjust the direction of the FM antenna.
- ➔ Adjust the position and direction of the AM antenna.
- ➔ Increase the distance between the system and TV or VCR.

### **DVD player operation**

#### **"NO DISC" is displayed.**



- ➔ Insert a disc correctly (label side up).
- ➔ Clean the disc.
- ➔ Use a new or readable disc.
- ➔ Wait until the moisture condensation at the lens has cleared.

#### **NO picture.**



- ➔ Place the disc on the disc tray correctly inside the guide.
- ➔ Clean the disc.
- ➔ Select the appropriate video input model on the TV so the picture from the unit appears on the TV.

### **USB operation**

#### **"NO USB" is displayed.**

- ➔ Press  button again after pressing  button.
- ➔ Insert the USB device properly.

#### **"NOT SUPPORT" is displayed.**

- ➔ Press  button again after pressing  button.

#### **Cannot play.**

- ➔ Check if the USB mass storage class-compatible digital audio player is turned ON.

### **iPod/iPhone operation**

#### **"NO iPod" is displayed.**

- ➔ Insert the iPod/iPhone properly.

#### **Does not function properly.**



- ➔ Disconnect the iPod/iPhone and connect it again.
- ➔ Check the software version of the iPod/iPhone. If it is not the latest one, update it.

### **SD operation**

#### **"NO SD" is displayed.**

- ➔ Press  button again after pressing  button.
- ➔ Insert the SD card properly.

#### **"NOT SUPPORT" is displayed.**

- ➔ Press  button again after pressing  button.

#### **Cannot play.**

- ➔ Insert an SD card containing music files.

### **D.AUDIO operation**

#### **Kenwood digital audio player cannot be controlled from the main unit or remote control unit.**

- ➔ Connect using the connection cable (separately available).
- ➔ Check if a compatible model is connected.

### **Remote control unit**

#### **Does not function properly.**

- ➔ Replace the batteries.
- ➔ Remove the obstacles.
- ➔ Move closer to the system when using the remote control and make sure that you are pointing at unit's remote sensor.

#### **"ON SCREEN" is displayed on main unit.**

- ➔ Confirm the operation on the monitor. Operate on the monitor if necessary.

## General information

### Maintenance

#### Cleaning the cabinet

- Use a soft cloth slightly moistened with a mild detergent solution. Do not use a solution containing alcohol, spirits, ammonia or abrasive.

#### Cleaning discs

- When a disc becomes dirty, clean it with a cleaning cloth, wipe the disc from the center out. Do not wipe in circular motion.
- Do not use solvents such as benzene, thinner commercially available cleaners, or antistatic spray intended for analogue records.

#### Caution on condensation

Condensation (of dew) may occur inside the unit when there is a great difference in temperature between this unit and the outside. This unit may not function properly if condensation occurs. In this case, leave the unit for a few hours and restart the operation after the condensation has dried up.

Be specially cautious against condensation in the following circumstances:

When this unit is carried from one place to another across a large difference in temperature, when the humidity in the room where this unit is installed increases, etc.

### To install speakers on a wall

Prepare commercially available wood screws.

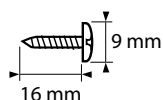

- 1 On a stable pillar or wall, attach a pair of wood screws at the same interval as the interval between the wall-mount holes of speaker.

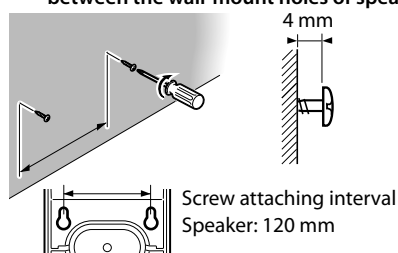

- 2 Fit the screws into the wall-mount holes on the rear of the speaker.

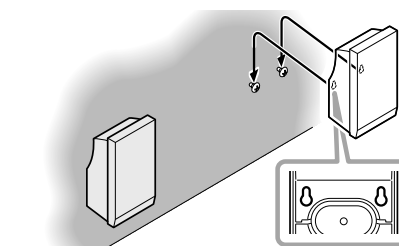

#### ⚠ CAUTION

Be sure to observe the following points when installing the unit on a wall. Otherwise, the product may drop and cause damage or an injury.

- Check the strength of the wall before installation. Do not install on a plywood or plaster board. If you have any doubt related to the wall strength, please consult a specialist.
- Check that the screws are fit securely into the wall-mount holes of the speakers.
- Even after installation, use care so that the speakers do not drop due to an accidental contact, etc.

## Specifications

### Main unit

#### Amplifier section

Rated output power  
.....20 W + 20 W (1 kHz, 10% T.H.D., at 8 Ω)  
D.AUDIO/ AUX (Sensitivity/ Impedance) .... 500 mV/10 kΩ  
SUBWOOFER PREOUT (Level/ Impedance) ..... 1.5 V/10 kΩ

#### Tuner section

FM tuner section  
Tuning frequency range.....87.5 MHz ~ 108.0 MHz  
AM tuner section  
Tuning frequency range.....531 kHz ~ 1,602 kHz

#### DVD player section

Laser.....Semiconductor laser  
[Video section]  
Video output format.....PAL  
Composite video output level .....1 Vp-p (75 Ω)  
Component Video output level  
Y-signal.....1 Vp-p (75 Ω)  
CB/ CR-signal.....0.7 Vp-p (75 Ω)  
HDMI output terminal.....Type A (19 PIN)

#### USB interface

USB standard.....USB 1.1/2.0  
Maximum supply current.....500 mA  
File system.....FAT 16/ 32

#### SD card interface

Format .....SD memory card  
Usable SD cards  
.....SD/SDHC, miniSD, microSD/SDHC card  
File system.....FAT 16/ 32

#### General

Provided AC adapter .....DC 18 V (AC 230 - 240 V, 50 Hz)  
Power consumption (Incl. AC adapter).....30 W  
Power consumption in standby mode.....1 W or less  
Dimensions .....W : 190 mm  
(with iPod applied part) W : 286 mm  
H : 240 mm  
D : 142 mm  
Weight (net) .....1.4 kg

### Speakers

Enclosure .....Bass-reflex type  
Speaker configuration  
Woofer.....86 mm, cone type  
Tweeter.....36 mm, cone type  
Impedance .....8 Ω  
Maximum input.....20 W  
Dimensions .....W : 170 mm  
H : 238 mm  
D : 132 mm  
Weight (net) .....1.1 kg (1 piece)

#### Notes:

- Kenwood follows a policy of continuous advancements in development. For this reason specifications may be changed without notice.
- Sufficient performance may not be exhibited at extremely cold locations (where water freezes).

#### Memory back up function

Please note that the following items will be deleted from the unit's memory if the power cord is disconnected from the AC outlet.

- Input selector settings
- Volume level
- Sound control (preset equalizer, bass enhancement)
- Tuner setting

**Declaration of Conformity with regard to the EMC Directive 2004/108/EC**

**Manufacturer:**

Kenwood Corporation  
2967-3 Ishikawa-machi, Hachioji-shi, Tokyo, 192-8525 Japan

**EU Representative's:**

Kenwood Electronics Europe BV  
Amsterdamseweg 37, 1422 AC UITHOORN, The Netherlands



**Information on Disposal of Old Electrical and Electronic Equipment and Batteries (applicable for EU countries that have adopted separate waste collection systems)**



Products and batteries with the symbol (crossed-out wheeled bin) cannot be disposed as household waste.



Old electrical and electronic equipment and batteries should be recycled at a facility capable of handling these items and their waste byproducts.



Contact your local authority for details in locating a recycle facility nearest to you.

**Pb**

Proper recycling and waste disposal will help conserve resources whilst preventing detrimental effects on our health and the environment.

Notice: The sign "Pb" below the symbol for batteries indicates that this battery contains lead.

- **DVD** is a trademark of DVD Format/Logo Licensing Corporation registered in the U.S., Japan and other countries.
- This product incorporates copyright protection technology that is protected by U.S. patents and other intellectual property rights of Rovi Corporation. Reverse engineering or disassembly is prohibited.
- Manufactured under license from Dolby Laboratories. Dolby and the double-D symbol are trademarks of Dolby Laboratories.
- DivX®, DivX Certified® and associated logos are trademarks of DivX, Inc. and are used under license.
- HDMI, the HDMI logo and High-Definition Multimedia Interface are trademarks or registered trademarks of HDMI Licensing, LLC.
- Windows Media is a trademark of Microsoft Corporation registered in the U.S. and other countries.
- SDHC logo is a trademark of SD-3C, LLC.
- "Made for iPod," and "Made for iPhone" mean that an electronic accessory has been designed to connect specifically to iPod, or iPhone, respectively, and has been certified by the developer to meet Apple performance standards. Apple is not responsible for the operation of this device or its compliance with safety and regulatory standards. Please note that the use of this accessory with iPod, or iPhone may affect wireless performance.
- iPhone, iPod, iPod classic, iPod nano, and iPod touch are trademarks of Apple Inc., registered in the U.S. and other countries.
- Manufactured under license from DTS Licensing Limited. DTS is a registered trademark & the DTS Logos and Symbol are trademarks of DTS, Inc. © 1996-2009 DTS, Inc. All Rights Reserved.

**KENWOOD**

**For your records**

Record the serial number, found on the back of the unit, in the spaces designated on the warranty card, and in the space provided below. Refer to the model and serial numbers whenever you call upon your dealer for information or service on this product.

Model \_\_\_\_\_ Serial Number \_\_\_\_\_