

KENWOOD

DVD/VCD/CD PLAYER

DVF-5400

INSTRUCTION MANUAL

Kenwood Corporation



Before applying power

⚠ Caution: Read this page carefully to ensure safe operation.

Units are designed for operation as follows.

U.S.A., Canada and US-Military
.....AC 110 - 240 V

AustraliaAC 240 V only
EuropeAC 230 V only

Information on Disposal of Old Electrical and Electronic Equipment (applicable for EU countries that have adopted separate waste collection systems)



Products with the symbol (crossed-out wheeled bin) cannot be disposed as household waste.





Old electrical and electronic equipment should be recycled at a facility capable of handling these items and their waste by products.

Contact your local authority for details in locating a recycle facility nearest to you.

Proper recycling and waste disposal will help conserve resources whilst preventing detrimental effects on our health and the environment.

Safety precautions

WARNING : TO PREVENT FIRE OR ELECTRIC SHOCK, DO NOT EXPOSE THIS APPLIANCE TO RAIN OR MOISTURE.

	CAUTION RISK OF ELECTRIC SHOCK DO NOT OPEN		CAUTION: TO REDUCE THE RISK OF ELECTRIC SHOCK, DO NOT REMOVE COVER (OR BACK). NO USER-SERVICEABLE PARTS INSIDE. REFER SERVICING TO QUALIFIED SERVICE PERSONNEL.
	THE LIGHTNING FLASH WITH ARROWHEAD SYMBOL, WITHIN AN EQUILATERAL TRIANGLE, IS INTENDED TO ALERT THE USER TO THE PRESENCE OF UNINSULATED "DANGEROUS VOLTAGE" WITHIN THE PRODUCT'S ENCLOSURE THAT MAY BE OF SUFFICIENT MAGNITUDE TO CONSTITUTE A RISK OF ELECTRIC SHOCK TO PERSONS.		
	THE EXCLAMATION POINT WITHIN AN EQUILATERAL TRIANGLE IS INTENDED TO ALERT THE USER TO THE PRESENCE OF IMPORTANT OPERATING AND MAINTENANCE (SERVICING) INSTRUCTIONS IN THE LITERATURE ACCOMPANYING THE APPLIANCE.		

The marking of products using lasers



The marking this product has been classified as Class 1. It means that there is no danger of hazardous radiation outside the product.

Location: Back panel

IMPORTANT SAFETY INSTRUCTIONS

⚠ Caution: Read this page carefully to ensure safe operation.

Read Instructions – All the safety and operating instructions should be read before the product is operated.

Retain Instructions – The safety and operating instructions should be retained for future reference.

Heed Warnings – All warnings on the product and in the operating instructions should be adhered to.

Follow Instructions – All operating and use instructions should be followed.

1. Cleaning – Unplug this product from the wall outlet before cleaning. Do not use liquid cleaners or aerosol cleaners. Use a damp cloth for cleaning.

2. Attachments – Do not use attachments not recommended by the product manufacturer as they may cause hazards.

3. Water and Moisture – This product shall not be exposed to dripping and splashing – for example, near a bath tub, wash bowl, kitchen sink, or laundry tub; in a wet basement; or near a swimming pool; and the like. Do not place an object containing liquid, such as a flower vase, on the appliance.

4. Accessories – Do not place this product on an unstable cart, stand, tripod, bracket, or table. The product may fall, causing serious injury to a child or adult, and serious damage to the product. Use only with a cart, stand, tripod, bracket, or table recommended by the manufacturer. Any mounting of the product should follow the manufacturer's instructions, and should use a mounting accessory recommended by the manufacturer. A product and cart combination should be moved with care. Quick stops, excessive force, and uneven surfaces may cause the product and cart combination to overturn.



5. Ventilation – Slots and openings in the cabinet are provided for ventilation and to ensure reliable operation of the product and to protect it from overheating, and these openings must not be blocked or covered. The openings should never be blocked by placing the product on a bed, sofa, rug, or other similar surface. This product should not be placed in a built-in installation such as a bookcase or rack unless proper ventilation is provided or the manufacturer's instructions have been adhered to.

6. Power Sources – This product should be operated only from the type of power source indicated on the product. If you are not sure of the type of power supply to your home, consult your product dealer or local power company.

7. CAUTION – Polarization – This product may be equipped with a polarized alternating-current line plug (a plug having one blade wider than the other). This plug will fit into the power outlet only one way. This is a safety feature. If you are unable to insert the plug fully into the outlet, try reversing the plug. If the plug should still fail to fit, contact your electrician to replace your obsolete outlet. Do not defeat the safety purpose of the polarized plug.

8. Power Cord Protection – Power-supply cords should be routed so that they are not likely to be walked on or pinched by items placed upon or against them, paying particular attention to cords at plugs, convenience receptacles, and the point where they exit from the product.

9. Lightning – For added protection for this product during a lightning storm, or when it is left unattended and unused for long periods of time, unplug it from the wall outlet and disconnect the antenna or cable system. This will prevent damage to the product due to lightning and power-line surges.

10. Overloading – Do not overload wall outlets, extension cords, or integral convenience receptacles as this can result in a risk of fire or electric shock.

11. Object and Liquid Entry – Never push objects of any kind into this product through openings as they may touch dangerous voltage points or short-out parts that could result in a fire or electric shock. Never spill liquid of any kind on the product.

12. Servicing – Do not attempt to service this product yourself as opening or removing covers may expose you to dangerous voltage or other hazards. Refer all servicing to qualified service personnel.

13. Damage Requiring Service – Unplug this product from the wall outlet and refer servicing to qualified service personnel under the following conditions:

- When the power-supply cord or plug is damaged,
 - If liquid has been spilled, or objects have fallen into the product,
 - If the product has been exposed to rain or water,
 - If the product does not operate normally by following the operating instructions.
 - If the product has been dropped or damaged in any way, and
 - When the product exhibits a distinct change in performance – this indicates a need for service.
- g)** If an abnormal smell or smoke is detected.

14. Replacement Parts – When replacement parts are required, be sure the service technician has used replacement parts specified by the manufacturer or have the same characteristics as the original part. Unauthorized substitutions may result in fire, electric shock, or other hazards.

15. Safety Check – Upon completion of any service or repairs to this product, ask the service technician to perform safety checks to determine that the product is in proper operating condition.

16. Wall or Ceiling Mounting – This product should be mounted to a wall or ceiling only as recommended by the manufacturer.

17. Heat – This product should be situated away from heat sources such as radiators, heat registers, stoves, or other products that produce heat. Do not place a flaming object, such as a candle or lantern, or near the product.

18. Power Lines – An outside antenna system should not be located in the vicinity of overhead power lines or other electric light or power circuits, or where it can fall into such power lines or circuits. When installing an outside antenna system, extreme care should be taken to keep from touching such power lines or circuits as contact with them might be fatal.

19. Outdoor Antenna Grounding – If an outside antenna or cable system is connected to the product, be sure the antenna or cable system is grounded so as to provide some protection against voltage surges and built-up static charges. Article 810 of the National Electrical Code, ANSI/NFPA 70, provides information with regard to proper grounding of the mast and supporting structure, grounding of the lead-in wire to an antenna discharge unit, size of grounding conductors, location of antenna-discharge unit, connection to grounding electrodes, and requirements for the grounding electrode.

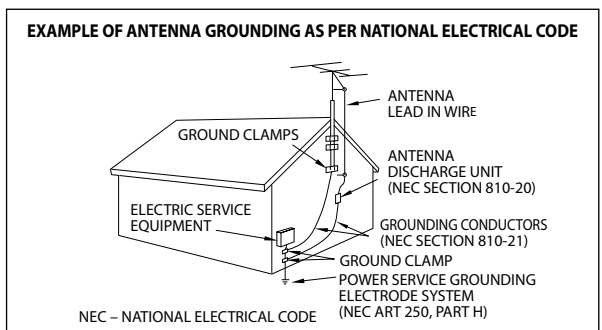

Notes:

- Item 7 is not required except for grounded or polarized equipment.
- Item 19 complies with UL in the U.S.A.

Before applying power

Accessories

Check that all accessories are present in the package.

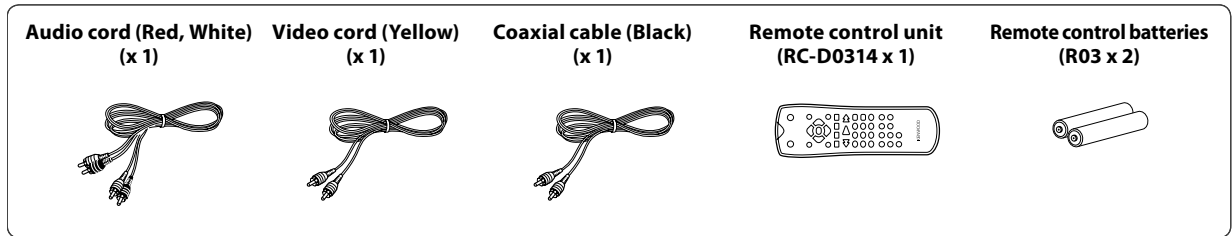

If any accessories are missing, or if the unit is damaged or fails to operate, notify your dealer immediately. If the unit was shipped to you directly, notify your shipper immediately. Kenwood recommends that you retain the original carton and packing materials in case you need to move or ship the unit in the future.

Keep this manual handy for future reference.

For the U.S.A.

CAUTION:

Use of controls or adjustments or performance of procedures other than those specified herein may result in hazardous radiation exposure. In compliance with Federal Regulations, the following are reproductions of labels on, or inside the product relating to laser product safety.

KENWOOD CORPORATION
2967-3, ISHIKAWA-CHO,
HACHIOJI-SHI,
TOKYO, JAPAN

KENWOOD CORP. CERTIFIES THIS EQUIPMENT
CONFORMS TO DHHS REGULATIONS NO. 21 CFR
1040.10, CHAPTER 1, SUBCHAPTER J.

Location: Back Panel

For the U.S.A.

FCC WARNING

This equipment may generate or use radio frequency energy. Changes or modifications to this equipment may cause harmful interference unless the modifications are expressly approved in the instruction manual. The user could lose the authority to operate this equipment if an unauthorized change or modification is made.

NOTE:

This equipment has been tested and found to comply with the limits for a Class B digital device, pursuant to Part 15 of the FCC Rules. These limits are designed to provide reasonable protection against harmful interference in a residential installation. This equipment may cause harmful interference to radio communications, if it is not installed and used in accordance with the instructions. However, there is no guarantee that interference will not occur in a particular installation. If this equipment does cause harmful interference to radio or television reception, which can be determined by turning the equipment off and on, the user is encouraged to try to correct the interference by one or more of the following measures:

- Reorient or relocate the receiving antenna.
- Increase the separation between the equipment and receiver.
- Connect the equipment into an outlet on a circuit different from that to which the receiver is connected.
- Consult the dealer or an experienced radio / TV technician for help.







For Canada

NOTICE: This Class B digital apparatus complies with Canadian ICES-003.

Special features



- **High Definition Multimedia Interface (HDMI) for finest audio and video digital quality (version 1.1)**
- **Graphical User Interface (G.U.I.)**
- **MPEG1 , MPEG2 files, DivX® video playback**
- **MP3, WMA and JPEG files playback**

This document classifies the applications of each feature using the following marks.

-  : Description of a feature that can be used with audio CD (CD-DA).
-  : Description of a feature that can be used with DVD video.
-  : Description of a feature that can be used with VCD.
-  : Description of a feature that can be used with DivX® video.
-  : Description of a feature that can be used with JPEG.
-  : Description of a feature that can be used with MP3.
-  : Description of a feature that can be used with WMA.

Contents

 **To ensure safety, read the items carrying this marking carefully.**

 Before applying power	2
 IMPORTANT SAFETY INSTRUCTIONS	3
Accessories	4
Special features	5
Contents	5
Discs information	6
Types of playable discs	6
Unplayable discs	6
Region Codes	7
Region codes in the world	7
Icons on the DVD VIDEO discs	7
Playable files with this unit	8
File Specifications	8
Creating media for playing back on this equipment	8
Video formats	9
For Your Information	10

Preparation

Connections	11
Controls and Indicators	14
Main unit	14
Remote control unit	14
Set Up functions	16
Preparation for Set Up	16
Set up menu	16
LANGUAGE	17
DISPLAY	17
AUDIO	17
LOCK (Parental Control)	18
OTHERS	19
Resolution setting	20
Hierarchical structure of VCD menus (P.B.C. function)	20
DVD menu language code list	21
Area Code code list	21

Operations

Basic playback of disc	22
On screen display	22
Last Scene Memory	22
Basic play	23
Disc playback features	24
Repeat play	24
A-B Repeat play	25
Program play	25
Movie disc playback	26
Select Audio Language	27
Select the Audio channel	27
Using Marker	27
Select Camera angle	28
Select Subtitle Language	28
Zoom function	28
Time Search	29
Music disc playback	30
Using the TV screen to start playback	30
Playback from desired track	30
To display the ID3 tag	30
Random play	30
Photo files playback (JPEG files only)	31
To start playback	31
Zoom function	31
To rotate picture	31
To hide the menu bar	31
Slide show	31

Knowledge

Troubleshooting	32
Specifications	34

Discs information

Types of playable discs

The system this unit is using does not only play music from CD but can also play the discs listed below to offer you high-quality entertainment of video of movies and live concerts.

Playable Disc	DVD VIDEO (DVD-R/RW, DVD+R/RW)		CD (CD-R, CD-RW)		VCD (SVCD*)	
Logo mark on disc						
Disc size	 8 cm	 12 cm	 8 cm	 12 cm	 8 cm	 12 cm
Played sides	One or both	One or both	One side only	One side only	One side only	One side only
Contents	Video + Audio	Approx. 41 min. (1 side, 1 layer) Approx. 75 min. (1 side, 2 layers) Approx. 82 min. (2 sides, 1 layer) Approx. 150 min. (2 sides, 2 layers)	Approx. 133 min. (1 side, 1 layer) Approx. 242 min. (1 side, 2 layers) Approx. 266 min. (2 sides, 1 layer) Approx. 484 min. (2 sides, 2 layers)			Max. 20 min. (8 cm) Max. 74 min. (12 cm)
	Audio			Max. 20 min., digital	Max. 80 min., digital	(In case of an SVCD, the possible playback time becomes shorter.)

Please refer to page 8 for the CD-R, CD-RW, DVD-R, and DVD-RW file formats which can be played back by this unit.

- * This unit can play SVCDs, but some functions will not work.
- A Dual Disc is a two-sided disc combining a DVD side according to the DVD standard and a music side. The video content recorded on the DVD side can be played back. As the music side is not compatible with the Compact Disc (CD) standard, playback on this unit is not assured.
- This unit can play back DVD-R and DVD-RW discs recorded in the DVD VIDEO format and DVD+R and DVD+RW discs, but depending on the recording unit, the disc manufacturer, etc., playback sometimes may not be possible.
- This unit may also be incapable of playing certain CD-R/RW discs depending on their properties, recording conditions, etc.
- This player cannot play back discs compatible with CPRM. CPRM is the abbreviation of Content Protection for Recordable Media, and it is a technique for copyright protection for recording media.

Unplayable discs

This player cannot play back any of the following discs.

- DVD AUDIO discs
- DVD-RAM discs
- SACD discs
- VSD discs
- CDV discs (Only the audio part can be reproduced.)
- CD-G/CD-EG/CD-EXTRA discs (Only the audio can be reproduced.)

- A DVD video disc with a region code which does not match this unit or without a region code. For details, see "Region Codes". (See page 7)
- When the video format of a disc differs from that of the TV in use, the disc cannot be played normally. For details, see "Video Formats". (See page 9)

Restrictions due to difference between discs

Some DVD and VCD discs can be played only in certain playback modes according to the intentions of the software producers. Depending on the condition of this unit, operation may be restricted. As this player plays discs according to their intentions, some functions may not work as intended by you. Please be sure to read the instructions provided with each disc. When an inhibition icon is displayed on the TV screen connected to the player, it indicates that the disc being played is under the restriction as described above.

Inhibition icon



Region Codes

Every player of this model has a certain region code assigned to it based on the country where the player is used. When the player is used to play back DVD VIDEO discs, it can only play the DVD VIDEO discs carrying the region codes matching the region code of the player.

The region code for this player is described on the rear panel of the player.

Region codes in the world

The DVD players are given a region code according to the country or area it is marketed, as shown in the following map.

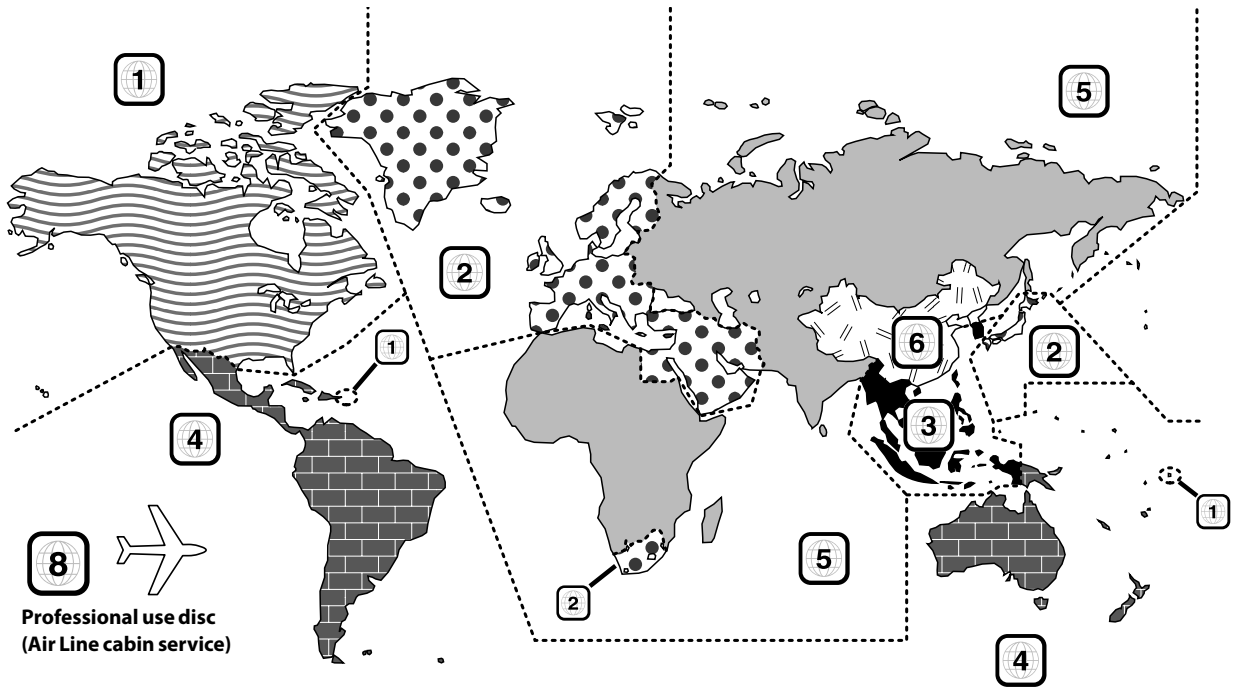

Region codes of the DVD VIDEO discs that can be played with this player

This player can play back a DVD VIDEO disc which carries the corresponding code to the region code of the player shown in the table above, a marking containing the region code of the player or the "ALL" marking shown below. Even when a DVD VIDEO disc does not carry any indication of the region code, it may sometimes be unable to be played on this player due to certain restrictions.



Icons on the DVD VIDEO discs

Icon	Description
	Indicates the region code where the disc can be played.
	Number of voice languages recorded with the audio function. The number in the icon indicates the number of voice languages. (Max. 8 languages)
	Number of subtitle languages recorded with the subtitle function. The number in the icon indicates the number of subtitle languages. (Max. 32 languages)
	Number of angles provided by the angle function. The number in the icon indicates the number of angles. (Max. 9 angles)
	Aspect ratios that can be selected. "4:3 Letter box" stands for Letter Box and "4:3 Panscan" for Pan/Scan. (See page 17) In the example on the left, the 16:9 video can be converted into letter box video.

Playable files with this unit

File Specifications

Category / Item	Extension	Detail	(Audio)	Media
MOVIE [file size : 4GB (Max.)]				
MPEG1	.MPG, .MPEG	Video resolution : 720 x 576 (Max.) Bit Rate : 5M bps (Max.)	Mpeg1 Layer1 & 2	CD-ROM CD-R CD-RW DVD-ROM DVD-R DVD+R DVD-RW DVD+RW (See page 6.)
MPEG2	.MPG, .MPEG	Video resolution : 720 x 576 (Max.) Bit Rate : 5M bps (Max.)	Mpeg1 Layer1 & 2	
DivX® VIDEO *	.AVI, .DIVX	Video resolution : 720 x 576 (Max.) Bit Rate : 10M bps (Max.)	WAV, MP3, WMA Dolby Digital	
MUSIC [file size : 4GB (Max.)]				
MPEG Audio	.MP3	Layer III Bit Rate 8 - 320 kbps, CBR/VBR FS 32k, 44.1k, 48k		
WMA (ver. 7)	.WMA	Bit Rate 32 - 320 kbps, CBR/VBR FS 32k, 44.1k, 48k		
WMA (ver. 8)	.WMA	Bit Rate 32 - 320 kbps, CBR/VBR FS 32k, 44.1k, 48k		
PHOTO [file size : 4MB (Max.)]				
JPEG	.JPG, .JPEG	Video resolution : 3072 x 2048 (Max.) 24 bit True color		

- Depending on the data recording condition and other factors, playback may not be possible.
- Usable formats for MP3/WMA/JPEG : ISO9660 level 1, 2 (excluding expanded formats : Joliet, Romeo)
- * Official DivX® Certified product.
Plays all versions of DivX® video (including DivX® 6) with standard playback of DivX® media files.

Creating media for playing back on this equipment

Compressing MP3/WMA

Please set up the transfer bit rate setting for the compression software when compressing MP3/WMA files as follow.

MP3 Files : 128 kbps recommended (8 - 320 kbps)

WMA Files : 128 kbps recommended (32 - 320 kbps)

- This unit is compatible with 32 kHz, 44.1 kHz (recommended) and 48 kHz sampling frequencies.
- This unit is compatible with ID3-TAG Ver. 1. (Alphanumeric sign : up to 30 characters)
- DIGITAL output of MP3/WMA data is done not as MP3/WMA data, but as PCM data.

Naming folders and files

Single-byte characters between A and Z, single-byte numerals between 0 and 9, and the single-byte underscore(_) can be displayed. Ensure that the extension log is attached to all file names.

- Never add the wrong extension log to any files, the equipment will assume that they can be played back, and this will produce loud noises in the speakers, resulting in damage of adverse effects.

Note:

Folder names and file names are displayed up to 20 characters. When folder names and file names are recorded with more than 20 characters, the names will be displayed in abbreviated form.

Confirming media and files

Check to ascertain that MP3/WMA files can be played back correctly on the personal computer in use prior to saving them onto the media. Check to ensure that the saved file can be played back normally.

- It is not possible to confirm that files can be played back correctly while they are being saved onto the media.

When saving files onto media

Ensure that the session is closed or finalized when data has been written on media. There are cases where media on which the session has not be closed or finalized will not be played back correctly with this equipment.

- There are cases where the folder names and file names will not be displayed correctly depending on the software used to save them.
- Do not store files or folders other than playable files on media to be played back with this equipment.
- It is recommended that ten or less sessions are stored when recording MP3/WMA files onto a media.
- In case of a multisession disc, some time may be required until playback begins.
- There are cases where playback is not possible when DivX/MP3/WMA/JPEG files (CD-ROM) and music CD information (CD-DA) are saved on the same media.

Example for a hierarchical structure

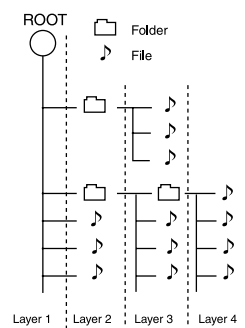

Video formats

The TV picture display and disc signal systems can be divided roughly into two TV formats (NTSC and PAL).

They are variable depending on countries and areas.

This unit has a function for changing the video format according to the TV type. Please confirm the type of your TV.

TV formats of major countries

TV Format	Major Countries & Areas
NTSC	Japan, Taiwan, Korea, USA, Canada, Mexico, Philippines, Chile, etc.
PAL	China, U.K., Germany, Australia, New Zealand, Kuwait, Singapore, etc.

Checking the Video Format

Check the video format of the TV to be used

When the video formats are different :

Try playing the disc. If the video formats of the disc and TV do not match, the played video may be black and white or become as shown below.

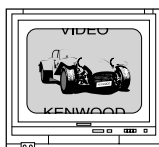

Top and bottom edges are not displayed.



Top and bottom areas are dark.

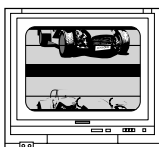

Picture turbulence due to sync unmatching.

To select TV Type (only for Europe and Australia)

- 1 Press the **[▲]** key to remove the disc from the unit, then close the tray.
- 2 Press and hold the **[II]** key on the remote control for more than 5 seconds to be able to select a TV type (PAL or NTSC).

For Your Information

Handling of disc

Handling precautions

Hold a disc taking care not to touch the played surface.

Notes on CD-R/CD-RW discs

If the CD-R or CD-RW disc in use has a printable label surface, the disc may be unable to be taken out of the system due to sticking of the label surface. To prevent malfunction of the system, do not use such a disc.

Cautions on discs

The disc rotates at a high speed during playback. Never use a cracked, chipped or greatly warped disc. Otherwise, damage or malfunction of the player may result.

Also, do not use a disc with a non-circular shape as this may result in malfunction.

Care and Storage

Care and storage of main unit

■ Do not place in the following locations.

- Place exposed to direct sunlight.
- Place subjected to excessive humidity or dirt.
- Place exposed to direct heat from heating equipment.

■ Be careful against condensation

When the difference in temperatures between the main unit and the environmental air is large, dew may be condensed inside the main unit and may cause malfunction of the main unit. If this happens, leave the main unit for a few hours until its internal mechanisms are dried up.

Take special care against condensation when the main unit is moved between places with a large temperature difference or into a room with high humidity.

■ When a main unit becomes dirty

When the front panel or case gets dirty, wipe with a soft dry cloth. Do not use lacquer thinner, benzine, alcohol or contact revitalizer for these chemicals will cause discoloration or deformation.

Care and storage of disc

■ Before storing the disc

When the main unit is not to be used for a long period, take out the disc and store in the case.

■ When a disc becomes dirty

- When a disc is contaminated with fingerprints or other stains, wipe gently in the radial direction using a soft dry cloth.
- Do not use an analog disk cleaner, lacquer thinner, benzine or alcohol.
- Do not use a disc accessory (stabilizer, protective sheet, protective ring, etc.) or lens cleaner.

■ Other cautions

- Do not write letters on a disc using a pencil or ball-point pen.
- Do not use a disc if the sticker or label on it is peeled off or bond is overflowed around the sticker or label.
- Do not stick a sheet of paper, sticker or label on a disc.

Caution for Transport or Movement

Before transporting or moving the system, prepare it as described below.

- ① Switch the system ON without placing a disc in it.
- ② Ensure that `NO DISC` is displayed.
- ③ Wait a few seconds, and then switch the system OFF.

Connections

⚠ CAUTION

Observe the following cautions when installing the system. Insufficient heat radiation may build up internal heat and cause a malfunction or fire hazard.

- Do not place an object that may hinder heat radiation on the system.
- Leave the spaces specified below around the cabinets of the main unit.

Top panel: 50 cm or more
 Side panel: 10 cm or more
 Back panel: 10 cm or more

Install the system so that the power outlet is easily accessible from the user, and unplug the power cord from the power outlet immediately in case of a trouble. Note that the power supply to the system is not shut down completely by simply setting the power key to OFF. To shut down the power supply completely, it is required to unplug the power cord.

Caution for connection

Do not plug the power cord into the power outlet until all other connections are completed. Before unplugging a connected cord or cable, be sure to set the power key to OFF and unplug the power cord from the power outlet in advance.

Malfunction of microcomputer

If the system does not work properly or the display shows wrong information even when correct connections are made, reset the microcomputer referring to "Operation to reset". (See page 32.)

Connecting to a TV with video (composite) or S-video input terminal

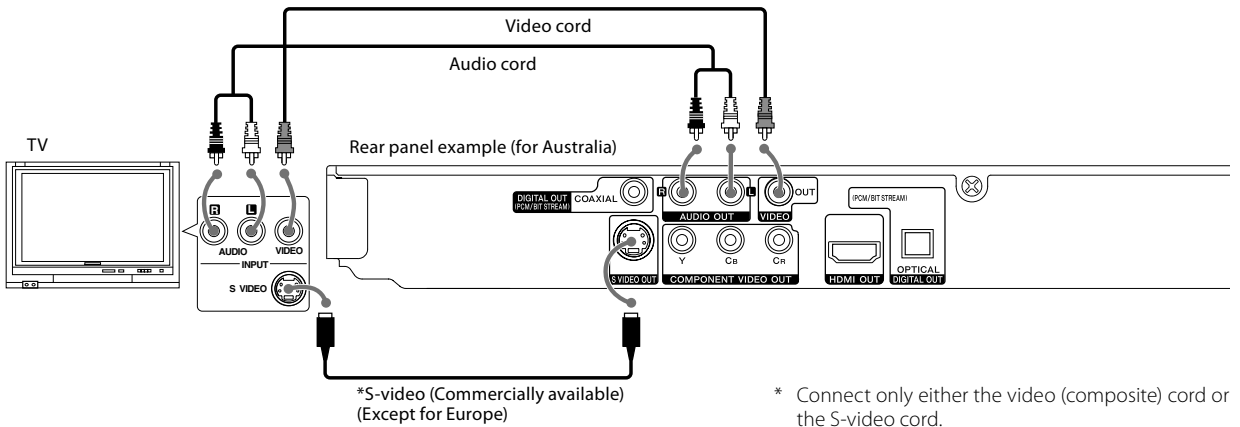

Connecting to a TV with SCART input terminal (For Europe)

Refer to "TV Output Select (only for Europe)" on page 17

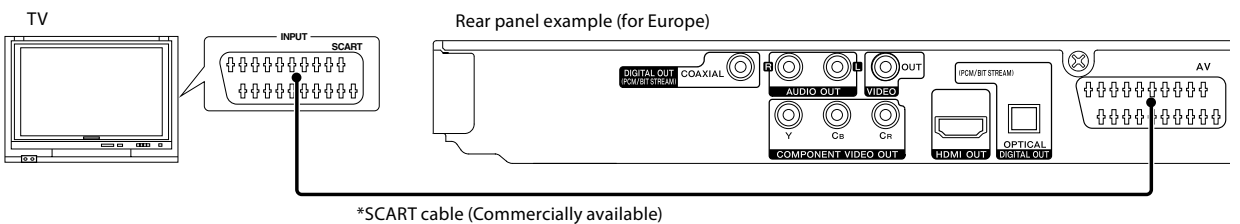

Note:
 Make sure the DVD player is connected directly to the TV and not to a VCR, otherwise the DVD image could be distorted by the copy protection system.

Connecting to a TV with Component input terminal

Refer to "TV Output Select (only for Europe)" on page 17.

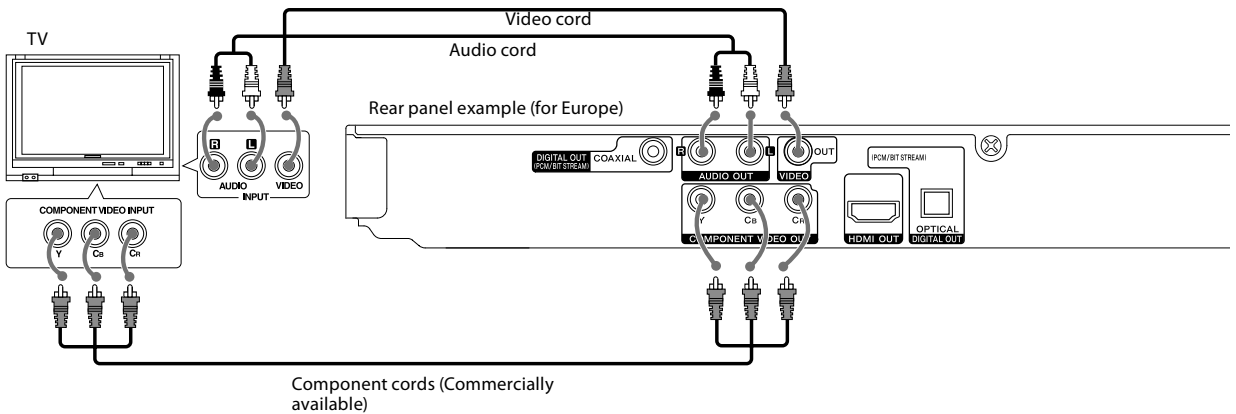

Connecting to an Audio component

For playback of DTS audio, please connect an AV receiver or an AV amplifier which can decode DTS by digital connection.

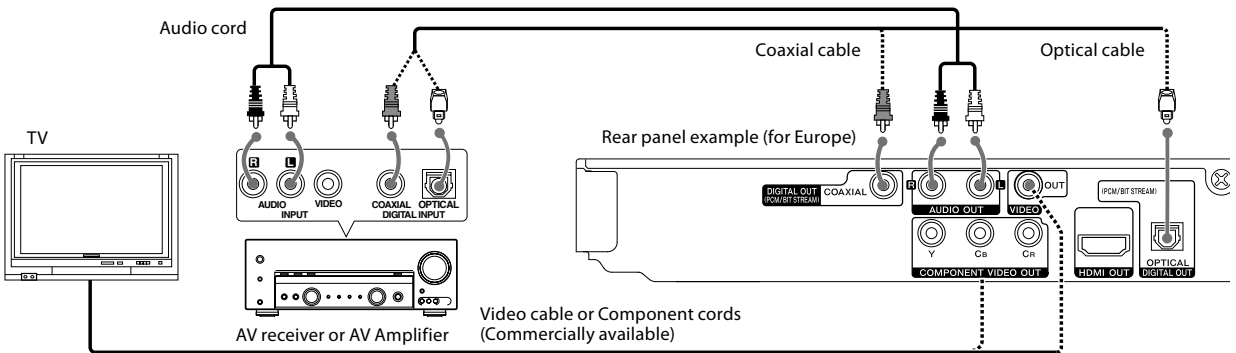

Amplifier equipped with 2-channel analog stereo or Dolby Pro Logic II / Pro Logic:

Connect the left and right AUDIO OUT jacks on the DVD player to the audio left and right IN jacks on your amplifier, receiver, or stereo system, using the audio cords.

Amplifier equipped with 2-channel digital stereo (PCM) or a multi-channel decoder (Dolby Digital™ or DTS):

Connect one of the DVD Player's DIGITAL OUT jacks (COAXIAL/OPTICAL) to the corresponding in jack on your amplifier. Use a digital (coaxial/optical) cable. Select "Bitstream" if you connect the DVD player to an amplifier or other equipment with a multi-channel decoder. (See page 17.)

DTS disclaimer clause

When playing DTS-encoded (CDs, DVDs), excessive noise will be exhibited from the analog stereo outputs. To avoid possible damage to the audio system, the consumer should take proper precautions when the analog stereo outputs of the DVD player is connected to an amplification system.

To enjoy DTS Digital Surround™ playback, an external 5.1 channel DTS Digital Surround™ decoder system must be connected to the digital output (S/P DIF, AES/EBU, or TosLink) of the DVD player.

Notes:

- In case an associated system component is connected, also read the instruction manual of the component.
- If the audio format of the digital output does not match the capabilities of your receiver (amplifier), the receiver produces a strong, distorted sound or no sound at all.

Connecting to a TV with HDMI input terminal

HDMI (High Definition Multimedia Interface) supports both video and audio on a single digital connection for use with DVD Players and other AV devices. If you have an HDMI TV or a monitor, you can connect it to this player using an HDMI cable.

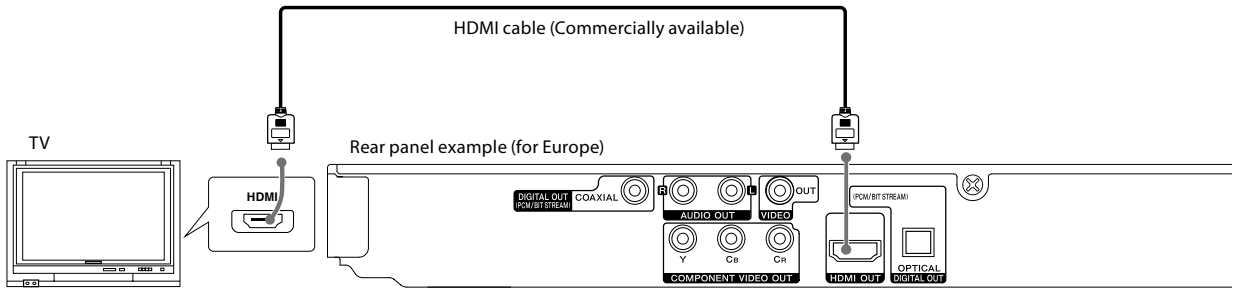

- If you connect the DVD player's DIGITAL OUT jack to an amplifier or other equipment with a multi-channel decoder, select "Bitstream" to enjoy Dolby Digital or DTS playback. (See page 17.)
- When the audio output option of DIGITAL OUT is set by the AUDIO setup, it is applied in both HDMI and digital out (Coaxial, Optical).
- When you use HDMI connection, you can change the resolution (576i (480i), 576p (480p), 720p, 1080i) for the HDMI output. (See page 20.)
- The HDMI will be outputted at 576p (480p) resolution, even if you set the resolution to 576i (480i) on the HDMI connection.

About HDMI

HDMI was developed to provide the technologies of HDCP (High-bandwidth Digital Content Protection). HDCP is used to protect digital content transmitted and received.

HDMI has the capability to support standard, enhanced or high-definition video plus standard to multi-channel surround-sound audio, HDMI features include uncompressed digital video, a bandwidth of up to 5 gigabytes per second, one connector (instead of several cables and connectors), and communication between the AV source and AV devices such as DTVs.

Notes:

- Both PCM and Bitstream Audio out is available when the sample frequency is set to 48 kHz in HDMI connection.
- If Audio setup is set to bitstream and your TV does not support Bitstream Audio out in HDMI connection, audio sound may not be outputted or distorted.
- When the no sound or noisy sound are outputted with HDMI connection, set the Audio option [Dolby Digital, DTS or MPEG] in SETUP menu to PCM or Off.
- If there is noise or lines on the screen, please check the HDMI cable.
- Not all HDCP-compatible DVI devices will work with this unit.
- If your HDMI TV does not support HDCP, the blue screen appears on the screen.
- If the abnormal picture appears on the TV screen, turn off the unit and then turn the unit on again.

Controls and Indicators

Main unit

Standby mode

At the time of power off with the power cord inserted into a power outlet, a small amount of power is supplied to the system to back up the memory. This status is referred to as the standby mode. During this mode, the system can be switched ON from the remote control unit.

Display

- **DVD video:**
Elapsed time of the title being played
- **Audio CD, VCD, DivX, MP3:**
Elapsed time of the track (or file) being played
- **At the time of audio CD stop mode:**
"0:00:00" displayed

Preparations

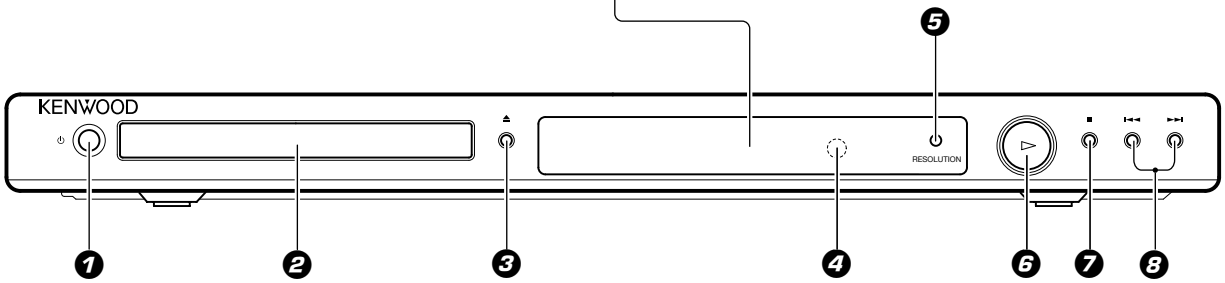

- 1 Power key (See page 16.)**
Switches the unit ON and standby.
- 2 Disc tray (See page 23.)**
- 3 Disc tray open/close (▲) key (See page 23.)**
Opens or closes the disc tray.
- 4 Remote control sensor (See page 15.)**
- 5 RESOLUTION key (See page 20.)**
Changes the resolution depending on your TV.
- 6 ► key (See page 23.)**
Starts playback.
- 7 ■ key (See page 24.)**
Stops playback.
- 8 ◀▶ keys (See page 24.)**
Skips or searches (by fast forward or fast reverse) a chapter or track.

Remote control unit

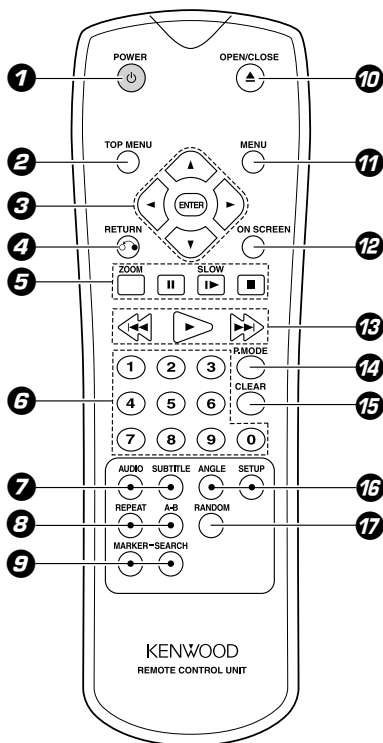

The remote control keys with the same names as the keys on the main system function in the same way as the keys on the main system.

- 1 Power key (See page 16.)**
Switches the unit ON and standby.
- 2 TOP MENU key (See page 23.)**
Accesses menu on a DVD disc.
- 3 ▲, ▼, ◀, ▶ keys**
Selects an item in the menu.
- ENTER key**
Confirms menu selection.
- 4 RETURN key (See page 20.)**
Returns on a VCD with PBC.
- 5 ZOOM key (See pages 28, 31.)**
Enlarges video image.
- II key (See pages 24, 26.)**
Pauses playback temporarily/press repeatedly for frame-by-frame playback.
- SLOW ► key (See page 26.)**
Starts slow motion playback.
- key (See page 24.)**
Stops playback.
- 6 Numeric keys (See pages 26, 29.)**
Selects numbered items in a menu.
- 7 AUDIO key (See page 27.)**
Selects an audio language or an audio channel.
- SUBTITLE key (See page 28.)**
Selects a subtitle language.

- 8 REPEAT key (See page 24.)**
Repeats playback.
- A-B key (See page 25.)**
Repeats sequence from point A to point B.
- 9 MARKER key (See page 27.)**
Marks any point during playback.
- SEARCH key (See page 27.)**
Displays Marker Search menu.
- 10 OPEN/CLOSE \blacktriangle key (See page 23.)**
Opens or closes the disc tray.
- 11 MENU key (See page 23.)**
Accesses menu on a DVD disc.
- 12 ON SCREEN key (See page 22.)**
Accesses On-Screen display.
- 13 \blacktriangleleft , \blacktriangleright keys (See page 24.)**
Skips or searches (by fast forward or fast reverse) a chapter or track.
- \blacktriangleright key (See page 23.)**
Starts playback.
- 14 P. MODE key (See page 25.)**
Enter the program edit mode.
- 15 CLEAR key (See pages 26, 27.)**
Removes a track number on the Program List or a mark on the Marker Search menu.
- 16 ANGLE key (See page 28.)**
Selects a DVD camera angle.
- SETUP key (See page 16.)**
Accesses or removes the Setup menu.
- 17 RANDOM key (See page 30.)**
Plays tracks in random order.

Loading batteries

- 1 Remove the cover.**

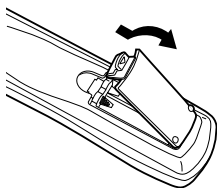

- 2 Insert batteries.**

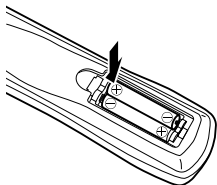

- Insert two R03 batteries following the polarity indications.

- 3 Close the cover.**

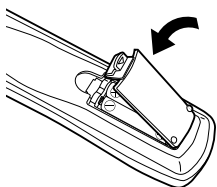

Operation

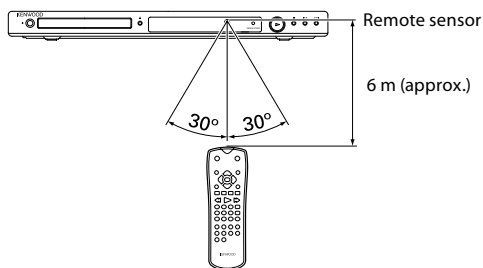

Plug the power cord of the system to a power outlet and press the power key on the remote control unit to turn the system ON. After the system is switched ON, press the desired operation key.

- When pressing more than one remote control keys in sequence, leave a period of about 1 second or more between each press.
- The provided batteries are intended for use in checking operations and their life may be shorter than usual.
- When the remote controllable distance becomes short, replace both of the batteries with new ones.
- The system may malfunction if the remote control sensor is exposed to direct sunlight or the light of a fluorescent lamp with high-frequency lighting system (inverter system, etc.). In this case, change the system installation to prevent malfunction.

Set Up functions

Preparation for Set Up

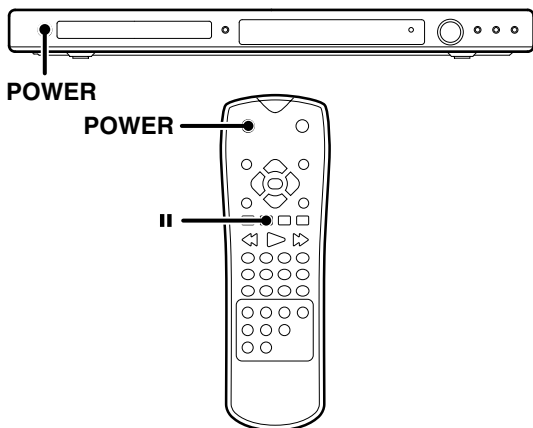

Preparations

1 Press the [POWER] key to power on.

2 Set Video Format according to the connected TV type. (Refer to "To select TV Type" on page 9.)

- If the video formats of the disc and TV do not match, press and hold [||] key for more than 5 seconds to be able to select a TV type (PAL or NTSC). (No disc inserted)

Note:

When the power cord is plugged, wait for several seconds, and then switch the power on.

Set up menu

By using the Setup menu, you can make various adjustments to items such as picture and sound.

You can also set a language for the subtitles and the Setup menu, among other things. For details on each Setup menu item, see pages 17 to 19.

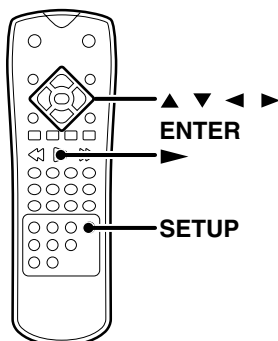

To display and exit the Menu

1 Press the [SETUP] key to display the menu. A second press of the [SETUP] key will take you back to initial screen.

To go to the next level:

Press the Cursor right [▶] key.

To go back to the previous level:

Press the Cursor left [◀] key.

General Operation

1 Press the [SETUP] key.

- The Setup menu appears.

2 Use the Cursor up/down [▲/▼] keys to select the desired option, then press the Cursor right [▶] key to move to the second level.

- The screen shows the current setting for the selected item, as well as alternate setting(s).

3 Use the Cursor up/down [▲/▼] keys to select the second desired option, then press the Cursor right [▶] key to move to the third level.

4 Use the Cursor up/down [▲/▼] keys to select the desired setting, then press the [ENTER] key to confirm your selection. Some items require additional steps.

5 Press the [SETUP] key or [▶] key to exit the Setup menu.

LANGUAGE

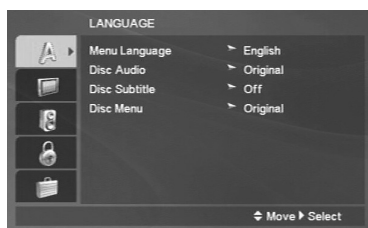

Menu Language

Select a language for the Setup menu and on-screen display.

Disc Audio/ Disc Subtitle/ Disc Menu

Select the language you prefer for the audio Track (disc audio), subtitles, and the disc menu

Original: Refers to the original language in which the disc was recorded.

Other: To select another language, press numeric keys then [ENTER] key to enter the corresponding digit number according to the language code list (See page 21.). If You enter the wrong Language code, press the [CLEAR] key.

DISPLAY

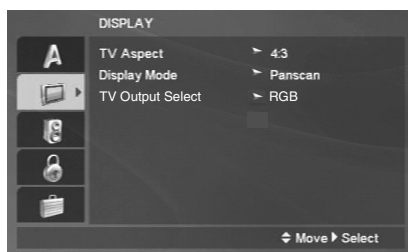

TV Aspect

4:3: Select when a standard 4:3 TV is connected.

16:9: Select when a 16:9 wide TV is connected.

Display Mode

Display Mode setting works only when the TV Aspect mode is set to "4:3".

Letterbox: Displays a wide picture with bands on the upper and lower portions of the screen.

Panscan: Automatically displays the wide Picture on the entire screen and cuts off the portions that do not fit.

TV Output Select (only for Europe)

Set the player's TV Output Select options according to the TV connection type.

RGB: When your TV is connected with the **SCART** jack.

Y Cb Cr: When your TV is connected with the **COMPONENT VIDEO** jacks on the DVD player.

Screen saver

The screen saver appears when you leave the DVD player in stop mode for about 5 minutes. If the Screen saver is displayed for 5 minutes, the DVD player automatically turns itself off.

AUDIO

Each DVD disc has a variety of audio output options. Set the player's AUDIO options according to the type of audio system you use.

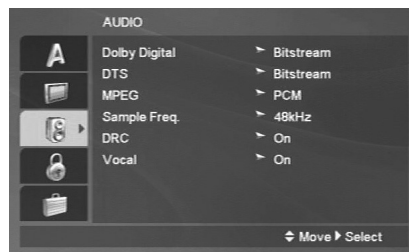

Dolby Digital/ DTS/ MPEG

Bitstream: Select "Bitstream" if you connect the DVD Player's **DIGITAL OUT** jack to an amplifier or other equipment with a Dolby Digital, DTS or MPEG decoder.

PCM (for Dolby Digital/ MPEG): Select when connected to a two-channel digital stereo amplifier. DVDs encoded in Dolby Digital or MPEG will be automatically down mixed to two-channel PCM audio.

Off (for DTS): If you select "Off", the DTS signal is not output through the **DIGITAL OUT** jack.

Sample Freq. (Frequency)

If your receiver or amplifier is NOT capable of handling 96 kHz signals, select 48 kHz. When this choice is made, this unit automatically converts any 96 kHz signals to 48 kHz so your system can decode them.

If your receiver or amplifier is capable of handling 96 kHz signals, select 96 kHz. When this choice is made, this unit passes each type of signal through without any further processing. Check the documentation for your amplifier to verify its capabilities.

When the disc prohibits 96 kHz digital output, the signal always is put out after down-conversion.

DRC (Dynamic Range Control)

With the DVD format, you can hear a program's soundtrack in the most accurate and realistic presentation possible, thanks to digital audio technology. However, you may wish to compress the dynamic range of the audio output (the difference between the loudest sounds and the quietest ones). This allows you to listen to a movie at a lower volume without losing clarity of sound. Set DRC to On for this effect.

This function operates only at the time of playback of DVDs recorded with Dolby Digital.

Vocal

Set to on only when a multi-channel karaoke DVD is playing. The karaoke channels on the disc mix into normal stereo sound.

LOCK (Parental Control)

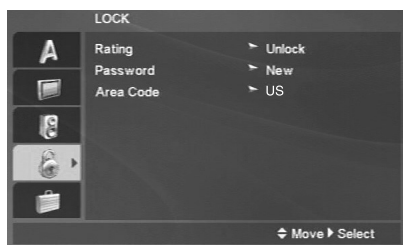

Rating

Some movies contain scenes that may not be suitable for children to view. Many of these discs contain parental control information that applies to the complete disc or to certain scenes on the disc. Movies and scenes are rated from 1 to 8, depending on the country. Some discs offer more suitable scenes as an alternative.

The parental control feature allows you to block access to scenes below the rating you input, thereby preventing your children from being able to view material you believe is unsuitable.

- 1 Select "Rating" on the LOCK menu then press the Cursor right [▶] key.
- 2 To access the Rating, Password and Area Code features, you must input the 4-digit password you created. If you have not yet entered a password you are prompted to do so.

Input a 4-digit password and press the [ENTER] key. Enter it again and press the [ENTER] key to verify. If you make a mistake before pressing [ENTER] key, press the [CLEAR] key.

- 3 Select a rating from 1 to 8 using the Cursor up/down [▲/▼] keys.

Rating 1-8: Rating one (1) has the most restrictions and rating eight (8) is the least restrictive.

Unlock

If you select unlock, parental control is not active and the disc plays in full.

Note:

If you set a rating for the player, all disc scenes with the same rating or lower are played. Higher rated scenes are not played unless an alternate scene is available on the disc. The alternative must have the same rating or a lower one. If no suitable alternative is found, playback stops. You must enter the 4-digit password or change the rating level in order to play the disc.

- 4 Press the [ENTER] key to confirm your rating selection, then press the [SETUP] key to exit the menu.

Password (Security Code)

You can enter or change password.

- 1 Select Password on the LOCK menu then press the Cursor right [▶] key.
- 2 Follow step 2 as shown "Rating" part. "Change" or "New" is highlighted.
- 3 Enter the new 4-digit code, then press the [ENTER] key. Input it again to verify.
- 4 Press the [SETUP] key to exit the menu.

If you forget Password

If you forget your password you can clear using the following steps:

- 1 Press the [SETUP] key to display the Setup menu.
- 2 Input the 6-digit number "210499" and the password is cleared.
- 3 Enter a new code as described above.

Area Code

Enter the code of the country/area whose standards were used to rate the DVD video disc, based on the list in the reference chapter.

Ratings are Area-dependent. (See page 21.)

- 1 Select "Area Code" on the LOCK menu, then press the Cursor right [▶].
- 2 Follow step 2 as shown "Rating" part.
- 3 Select the first character using the Cursor up/down [▲/▼] keys.
- 4 Shift the cursor using the Cursor right [▶] key and select the second character using the Cursor up/down [▲/▼] keys.
- 5 Press the [ENTER] key to confirm your Area code selection.

OTHERS

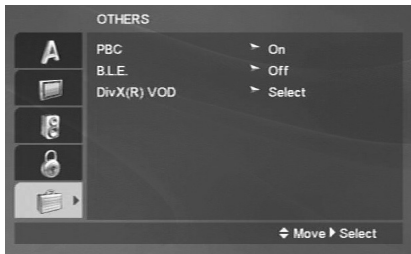

PBC (VCD)

Set Playback Control (PBC) to On or Off.

On: Video CDs with PBC are played according to the PBC.

Off: PBC is switched off and normal playback is made.

B.L.E. (Black Level Expansion)

To select the black level of playback pictures.
Set your preference and monitor's ability.

On: Expanded grey scale. (0 IRE cut off)

Off: Standard grey scale. (7.5 IRE cut off)

Note:

The B.L.E. function works NTSC system only.

DivX(R) VOD (DivX)

You can display the DivX DRM (Digital Rights Management) Registration code for your unit only.

The Registration code is used for VOD (Video-On-Demand) service agent. You can purchase or rent an encrypt movie file.

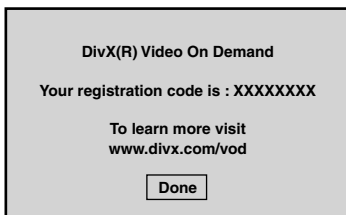

If you rent the DivX VOD file, it has several options of viewing limits as shown below.

Display the number which you can watch the file.

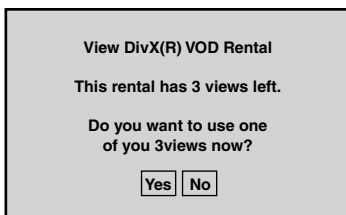

The rental has been expired.

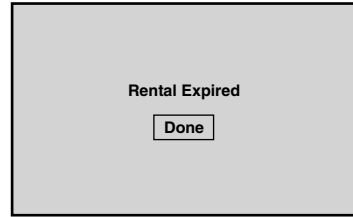

Display the authorization error.



Resolution setting

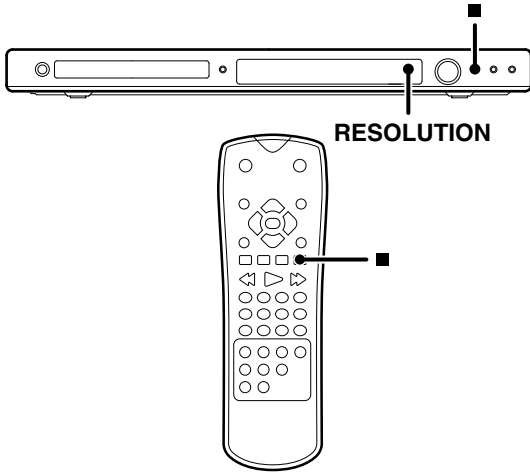

1 Press the [■] key to stop playback.

2 Press the [RESOLUTION] key once.

- The current resolution setting will be appears in the display window.

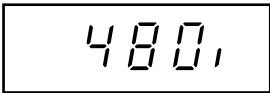

3 Press the [RESOLUTION] key repeatedly to change the resolution you want.

The available resolution according to the connections are as shown below.

Output Connection	Available Resolution	
	PAL	NTSC
HDMI VIDEO OUT	1920 x 1080i	1920 x 1080i
	1280 x 720p	1280 x 720p
	720 x 576p	720 x 480p
	720 x 576i	720 x 480i
COMPONENT VIDEO OUT	1280 x 720p	1920 x 1080i
	720 x 576p	1280 x 720p
	720 x 576i	720 x 480p
VIDEO OUT	720 x 576i	720 x 480i
SCART	720 x 576i	720 x 480i

Notes:

- For VIDEO OUT and SCART connections, resolution must be set to 576i (480i) by pressing [RESOLUTION] key.
- If your TV does not accept your resolution setting, abnormal picture appears on the screen. Please read TV's owner's manual then set the resolution that your TV can accept.
- For 720p and 1080i resolution on the component video out, only non-copy protected discs can be played back. If the disc is copy protected, it will be displayed at the 576p (480p) resolution without HDMI cable connection. With HDMI cable connection, the picture may not be displayed properly.

Hierarchical structure of VCD menus (P.B.C. function)

When an item is selected on the menu screen during playback of a P.B.C.-compatible VCD, another menu with more details items may be displayed. When a number of menus are connected in multiple layers in this way, it is said that the menus have a hierarchical structure. In this structure, the desired scene can be reached by repeating item selections on the menu screens.

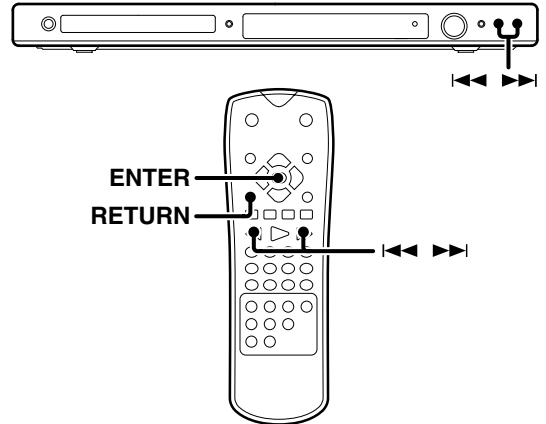

Example for a hierarchical structure

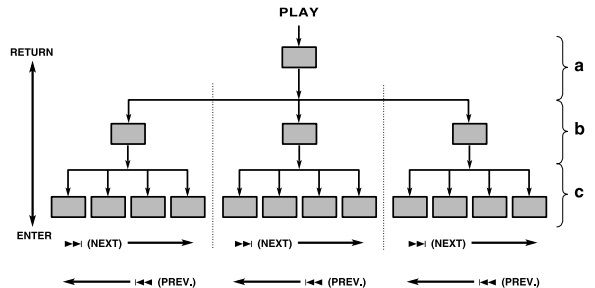

- a: First level (menu)
- b: Second level (submenu)
- c: Third level (scenes)

Advancing

When an item is selected on the menu screen with the [ENTER] key or the numeric keys, advance is made to the next lower menu level. When the advance destination is the "scene" to be played, the contents will be played.

- When several menus (scenes) can be selected in each level, screen switching is possible with the keys ►► (NEXT) and ◀◀ (PREV.).

Returning

Each time the [RETURN] key is pressed, return is made to the next higher menu.

DVD menu language code list

Language	Code	Language	Code	Language	Code	Language	Code
Abkhazian	6566	Fiji	7074	Lingala	7678	Singhalese	8373
Afar	6565	Finnish	7073	Lithuanian	7684	Slovak	8375
Afrikaans	6570	French	7082	Macedonian	7775	Slovenian	8376
Albanian	8381	Frisian	7089	Malagasy	7771	Somali	8379
Ameharic	6577	Galician	7176	Malay	7783	Spanish	6983
Arabic	6582	Georgian	7565	Malayalam	7776	Sudanese	8385
Armenian	7289	German	6869	Maltese	7784	Swahili	8387
Assamese	6583	Greek	6976	Maori	7773	Swedish	8386
Aymara	6588	Greenlandic	7576	Marathi	7782	Tagalog	8476
Azerbaijani	6590	Guarani	7178	Moldavian	7779	Tajik	8471
Bashkir	6665	Gujarati	7185	Mongolian	7778	Tamil	8465
Basque	6985	Hausa	7265	Nauru	7865	Tatar	8484
Bengali; Bangla	6678	Hebrew	7387	Nepali	7869	Telugu	8469
Bhutani	6890	Hindi	7273	Norwegian	7879	Thai	8472
Bihari	6672	Hungarian	7285	Oriya	7982	Tibetan	6679
Breton	6682	Icelandic	7383	Panjabi	8065	Tigrinya	8473
Bulgarian	6671	Indonesian	7378	Pashto, Pushto	8083	Tonga	8479
Burmese	7789	Interlingua	7365	Persian	7065	Turkish	8482
Byelorussian	6669	Irish	7165	Polish	8076	Turkmen	8475
Cambodian	7577	Italian	7384	Portuguese	8084	Twi	8487
Catalan	6765	Japanese	7465	Quechua	8185	Ukrainian	8575
Chinese	9072	Javanese	7487	Rhaeto-Romance	8277	Urdu	8582
Corsican	6779	Kannada	7578	Rumanian	8279	Uzbek	8590
Croatian	7282	Kashmiri	7583	Russian	8285	Vietnamese	8673
Czech	6783	Kazakh	7575	Samoan	8377	Volapük	8679
Danish	6865	Kirghiz	7589	Sanskrit	8365	Welsh	6789
Dutch	7876	Korean	7579	Scots Gaelic	7168	Wolof	8779
English	6978	Kurdish	7585	Serbian	8382	Xhosa	8872
Esperanto	6979	Laothian	7679	Serbo-Croatian	8372	Yiddish	7473
Estonian	6984	Latin	7665	Shona	8378	Yoruba	8979
Faroese	7079	Latvian, Lettish	7686	Sindhi	8368	Zulu	9085

Area Code code list

Area	Code	Area	Code	Area	Code	Area	Code
Afghanistan	AF	Ethiopia	ET	Malaysia	MY	Saudi Arabia	SA
Argentina	AR	Fiji	FJ	Maldives	MV	Senegal	SN
Australia	AU	Finland	FI	Mexico	MX	Singapore	SG
Austria	AT	France	FR	Monaco	MC	Slovak Republic	SK
Belgium	BE	Germany	DE	Mongolia	MN	Slovenia	SI
Bhutan	BT	Great Britain	GB	Morocco	MA	South Africa	ZA
Bolivia	BO	Greece	GR	Nepal	NP	South Korea	KR
Brazil	BR	Greenland	GL	Netherlands	NL	Spain	ES
Cambodia	KH	Islands	HM	Netherlands Antilles	AN	Sri Lanka	LK
Canada	CA	Hong Kong	HK	New Zealand	NZ	Sweden	SE
Chile	CL	Hungary	HU	Nigeria	NG	Switzerland	CH
China	CN	India	IN	Norway	NO	Taiwan	TW
Colombia	CO	Indonesia	ID	Oman	OM	Thailand	TH
Congo	CG	Israel	IL	Pakistan	PK	Turkey	TR
Costa Rica	CR	Italy	IT	Panama	PA	Uganda	UG
Croatia	HR	Jamaica	JM	Paraguay	PY	Ukraine	UA
Czech Republic	CZ	Japan	JP	Philippines	PH	United States	US
Denmark	DK	Kenya	KE	Poland	PL	Uruguay	UY
Ecuador	EC	Kuwait	KW	Portugal	PT	Uzbekistan	UZ
Egypt	EG	Libya	LY	Romania	RO	Vietnam	VN
El Salvador	SV	Luxembourg	LU	Russian Federation	RU	Zimbabwe	ZW





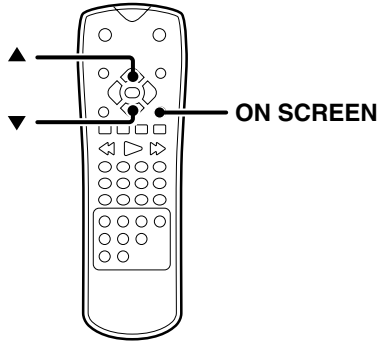

Basic playback of disc

On screen display



The on-screen Banner Display contains many playback features. To see the Banner Display, press the [ON SCREEN] key while a disc is playing. Use the Cursor up/down [▲/▼] keys to move through the different features in the Banner Display. Each feature is illustrated with an icon.







Example: On-Screen Display during playing DVD video

 1 / 3	Title Number
 1 / 12	Chapter Number
 00:20:09	Time search
 1 ENG DOD 3/2.1	Audio language and Digital Audio Output mode
 1 ENG	Subtitle language
 1 / 3	Angle

On-Screen Display during playing VCD

 1 / 3	Track Number (or PBC mode)
 00:20:09	Time search
 Stereo	Audio Channel

On-Screen Display during playing DivX

 1 / 3	Track Number
 00:20:09	Time search
 1 MP3 2/0 CH	Audio language and Digital Audio Output mode
 1	Subtitle language

Note:

The on screen display is switched off when no operation is performed for a few seconds.

Last Scene Memory

This player memorizes last scene from the last disc that is viewed. The last scene remains in memory even if you remove the disc from the player or switch off the player. If you load a disc that has the scene memorized, the scene is automatically recalled.

If you don't want to use the Last Scene Memory, press the [■] key during stop.

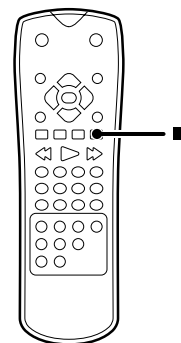

Note:

This player does not memorize the scene of a disc if you switch off the player before commencing to play the disc.

Basic play

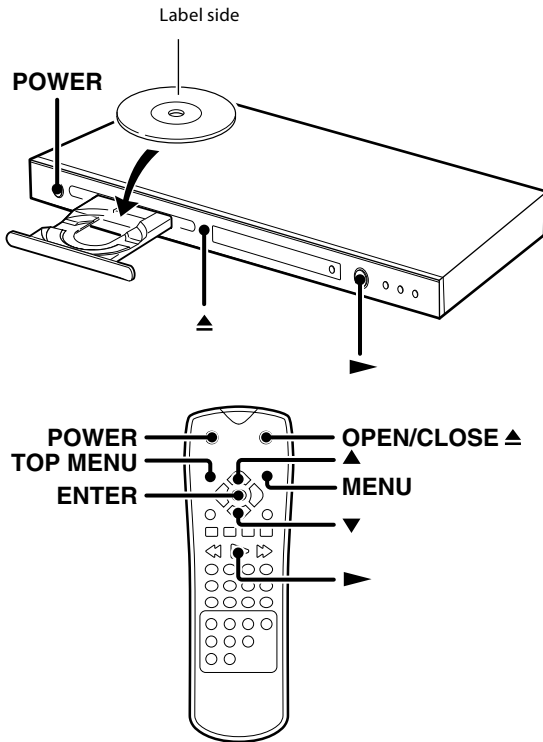

- 1 Press the [POWER] key to power on.
- 2 Press the [▲] key to open the tray.
- 3 Place a disc.
- 4 Start playback.

To start playback of DVD video, audio CD or VCD

Press the [▶] key.

Elapsed time of the title, track or file display

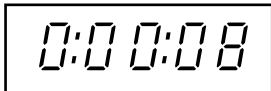

- When [▶] key is pressed while a tray is open, the tray closes automatically, and then playback begins

Note:

When a Disc Menu appears on the screen

In case of interactive DVDs, a Disc Menu appears on the screen. Then press the [ENTER] key to select specific menu you want to play by using Cursor keys.

To start playback of audio CD, DivX, MP3, WMA or JPEG files

It is not possible to play back folders and files that exceed the maximum limitations of the media.

A certain amount of time is required for the player to confirm the media on which DivX/MP3/WMA/JPEG files have been recorded before playback will commence.

Press Cursor up/down [▲/▼] keys to select desired track or file, then press the [▶] key or the [ENTER] key to start playback.

Press the [MENU] key to go to the next page.

Example of MP3 menu

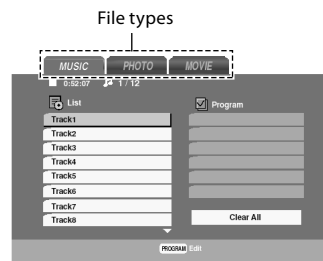

Example of JPEG menu

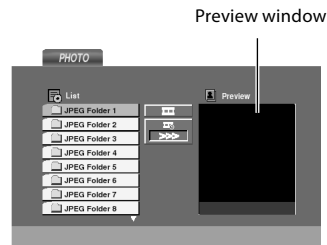

- When JPEG files are displayed, the display is switched automatically from one file to the next. (Slide Show)
- When different file types like music, photo, and movie files are mixed on one disc, press the [TOP MENU] key and select the file type (music, photo, movie; see page 8.) to be played back.

Notes:

- After all files of a folder have been played, playback will stop.
- If you are in a file list on the MP3/WMA menu and want to return to the folder list, use Cursor up/down [▲/▼] keys to highlight [▶] and press the [ENTER] key.

Disc playback features

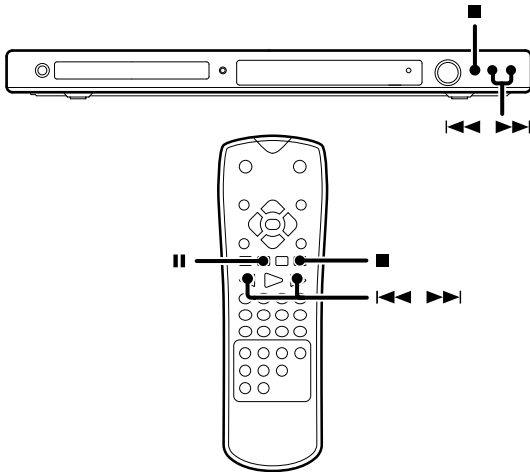

Notes:

- You won't hear the sound (audio) on the DVD, VCD and DivX when you're using the Skip, Search, Step or Slow motion features.
- Playback features are not available during the opening credits of a movie.

To stop playback



Press the [■] key.

To pause playback



Press the [II] key.

- Each press pauses and plays the disc alternately.
- During DVD playback, step operation is performed each time this key is pressed. (See page 26.)

Skipping chapters, tracks or files



Press the [◀◀] or [▶▶] key.

- The chapter (or track) in the direction of the key pressed is skipped, and the selected chapter (or track) will be played from the beginning.
- When the [◀◀] key is pressed once during playback, the chapter (or track) being played will be played from the beginning.
- When the [◀◀] key is pressed within 3 seconds after the start of chapter (or track) playback, playback starts from the start of the preceding chapter (or track).

Note:

The Chapter feature won't work if the disc isn't formatted with separate chapters.

Searching

During playback, press the [◀◀] or [▶▶] key for more than 2 seconds to select the searching speed, then release the key.

Each press and hold the [◀◀] or [▶▶] key switches the searching speed.

At the time of DVD video or DivX playback

- ▶ (Normal speed)
- ▶▶
- ▶▶▶
- ▶▶▶▶
- ▶▶▶▶▶

At the time of VCD playback

- ▶ (Normal speed)
- ▶▶
- ▶▶▶
- ▶▶▶▶

At the time of audio CD or MP3 playback

- ▶ (Normal speed)
- ▶▶ x 2
- ▶▶ x 4
- ▶▶ x 8

- Press the [▶] key at any time to resume normal playback.

Repeat play

Desired title, chapter, track or disc can be played back repeatedly.

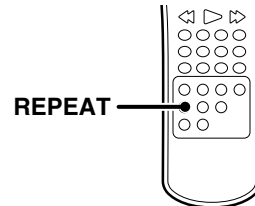

During playback, press the [REPEAT] key.

Repeat icon

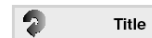

Each press switches the selection.

At the time of DVD video playback

- "Chapter"
- "Title"
- "Off" (Repeat off)

At the time of audio CD, VCD, DivX, MP3 or WMA playback

- "Track"
- "All"
- Goes off (Repeat off)

- To cancel repeat playback, press the [REPEAT] key and select "Off".

Notes:

- If you press the [▶▶] once during Repeat Chapter or Repeat Track playback, the repeat playback cancels.
- P.B.C. on mode of VCD, the Repeat play function does not work.

A-B Repeat play

The A-B repeat function lets you mark a segment to repeat between the beginning "A" and the end "B" of the segment you want to replay.

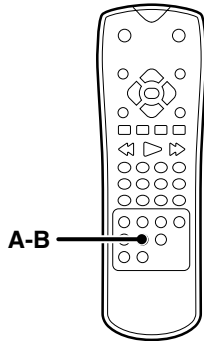

- 1 Press the [A-B] key when you want to choose a scene (sound) as the beginning point.

Repeat A icon

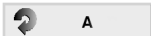

- "A" display appears.

- 2 Press the [A-B] key again to choose a scene (sound) as the end point.

Repeat A-B icon

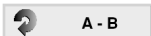

- "A-B" display appears and the repeat sequence begins.
- To cancel A-B Repeat playback, press the [A-B] key.

Program play

You can listen to the desired tracks of the current CD, MP3 or WMA in any desired order.

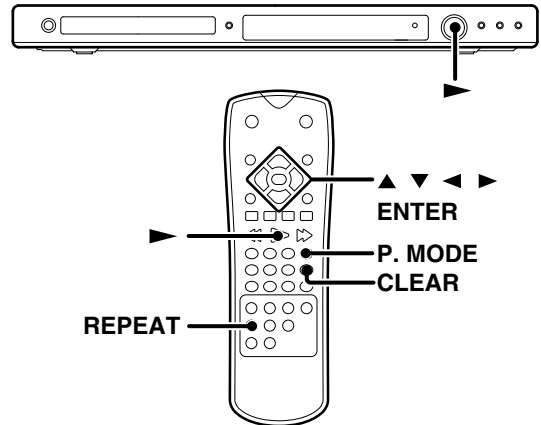

Program Edit

- 1 Insert a disc and close the tray.

- Audio CD or MUSIC menu appears.

- 2 Press the [P. MODE] key.

- The **E** mark will appear to the right of the word "Program" on the right side of the menu screen.

Example of Audio CD menu

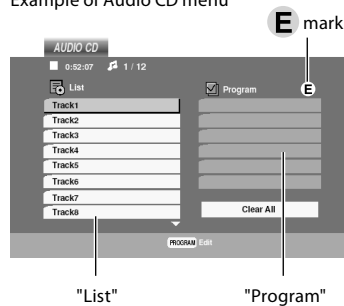

- To exit the Program Edit mode, press the [P. MODE] key again.

- 3 Select a specific track on the "List" by pressing Cursor up/down [▲/▼] keys, then press the [ENTER] key to place the selected track on the "Program" list.

- 4 You can select maximum 30 values by repeating step 3.

- 5 Select the track you want to start playing on the Program list by pressing Cursor up/down [▲/▼] keys.

- 6 Press the [▶] key to start.

- Playback begins in the order in which you programmed tracks. Playback stops after all of the tracks on the Program list have played once.
- The unit stops when the [■] key is pressed. To restart program play, press the [▶] key.

To repeat program play

During program playback, press the [REPEAT] key.

Each press switches the selection.

- ① "TRACK" : repeats the current track or file.
- ② "ALL" : repeats all the tracks (files) on programmed list.
- ③ Goes off (repeat off)

Note:

If you press the [▶▶] once during Repeat Track playback, the repeat playback cancels.

Delete a track from Program list

- 1 During stop mode, press the [P. MODE] and the **E** mark will appear.
- 2 Press the Cursor [**◀/▶/▲/▼**] keys to select the track that you wish to delete from the Program list.
- 3 Press the [CLEAR] key.

Delete the complete Program list

- 1 During stop mode, press the [P. MODE] and the **E** mark will appear.
- 2 Select "Clear All", then press the [ENTER] key.
 - The complete program for the disc is deleted.
 - The programs are also cleared when the disc is removed.

Movie disc playback

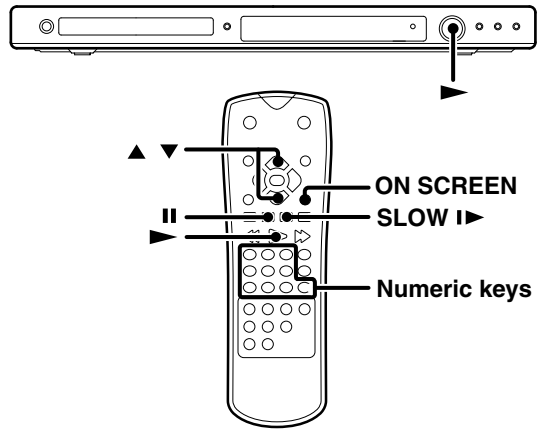

STEP (freeze frame and frame advance) **DVD VCD DivX**

During playback, press the [II] key.

- Each time you press the key, the picture advances one frame.
- Press the [▶] key to resume normal playback.

Slow motion playback **DVD VCD DivX**

During playback, press the [SLOW ▶] key.

Each press switches the motion speed.
(Slow Reverse is not possible)

- ① 1/7
- ② 1/6
- ③ 1/4
- ④ 1/2

- Press the [▶] key to resume normal playback.
- Slow motion playback is not available for playing the VR disc.

Playback from desired title, chapter or track **DVD VCD DivX**

Because DVD video discs use digital technology, a title can be divided into individual chapters (similar to tracks on a CD).

At the time of DVD video playback

- 1 Press the [ON SCREEN] key.
- 2 Press the Cursor up/down [**▲/▼**] keys to select the title or chapter icon.



- 3 Press the numeric keys, then press the [▶] key.

To select track No. 23: 2, 3 and ▶

Note:

The Chapter feature won't work if the disc isn't formatted with separate chapters.

Continued to next page

At the time of VCD playback

Press the numeric keys, then press the [▶] key.

To select track No. 23: 2, 3 and ▶

Note:

P.B.C. on mode of VCD, the Selecting a Track function may not work. (See page 20.)

Select Audio Language

If the disc was created with different language tracks, you can use the [AUDIO] key to temporarily change the DVD player's Audio setting.

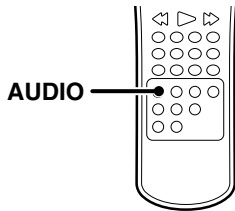

During playback, press the [AUDIO] key.

The language is switched each time the [AUDIO] key is pressed.



DVD Audio language icon



DivX Audio language icon

Notes:

- The language feature only works if the disc was created with multiple audio tracks.
- When you chose an audio language by the [AUDIO] key, you only override the audio language setting in the DVD Player's main menu (in the Language Preferences menu within Setup menu) temporarily.

Select the Audio channel

You can choose to play back only the right or the left channel of audio recorded on the disc, or you can select stereo playback.

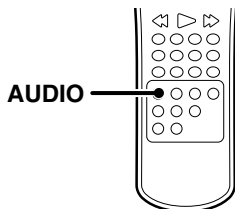

During VCD playback, press the [AUDIO] key.



Audio channel icon

Each press switches the selection.

- ① LEFT
- ② RIGHT
- ③ STEREO

Using Marker

The marker feature lets you mark a point on the disc that you can go to quickly. You can store up to 9 marker points

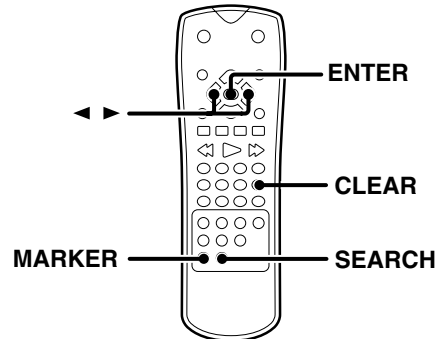

Create the Marker

When you reach the scene you want to mark, press the [MARKER] key.



- The marker icon appears on the TV screen briefly.
- Repeat to enter up to 9 marker points.

To recall or clear a marked scene

1 During playback, press the [SEARCH] key.



- The marker search menu appears on the screen.

2 Press the Cursor right/left [◀/▶] keys to select a marker number that you want to recall or clear.

3 Press the [ENTER] key to playback from the marked scene or press the [CLEAR] key to clear the selected number.

Notes:

- Depending on the disc, the marker function may not work.
- P.B.C. on mode of VCD, the marker function does not work. (See page 20.)
- The marker points are cleared each time a disc is removed from the player or when the power is turned off.

Select Camera angle

Some disc contains multiple angles particular scene or sequence. If the disc only has one angle, this feature won't work. When you are playing a DVD disc contains scenes recorded different camera angles, the angle indicator will blink on the TV screen.

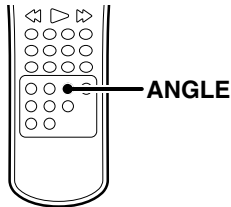

- 1 During the angle indicator has blinked, press the [ANGLE] key.

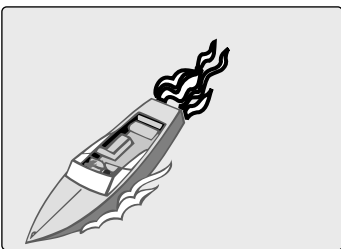

- 2 Select the Camera angle with press the [ANGLE] key.

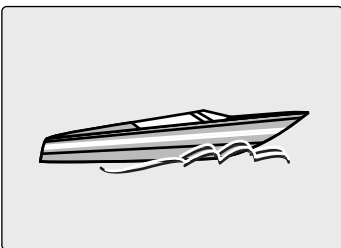

Select Subtitle Language

You can change the Subtitle language while you're watching a disc (but only if the disc was created with subtitles).

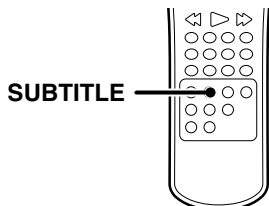

- During playback, press the [SUBTITLE] key.

The language is switched each time the [SUBTITLE] key is pressed.

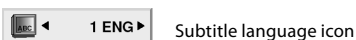

Notes:

- The subtitle feature only works if the disc was created with multiple subtitle tracks.
- The subtitle menu of the disc appears in some discs.
- The subtitle file of the DivX file is displayed only srt, txt, smi, ssa and sub.
- If there is no information or there is a code that can not read in the DivX file, " 1 " etc are displayed.

Notice for displaying the DivX subtitle

If the subtitle does not display properly, please follow the steps below.

- 1 Press the [II] key when the subtitle appears.
- 2 Press and hold [SUBTITLE] key for about 3 seconds. The language code will appear.
- 3 Press the Cursor right/left [◀/▶] keys to select another language code until the subtitle is displayed properly.
- 4 Press the [▶] key to continue playback.

Zoom function

Use zoom to enlarge the video image.

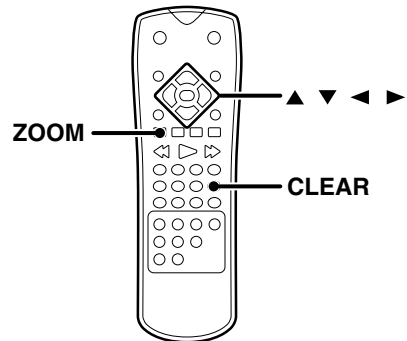

- 1 During playback, press the [ZOOM] key.

- The square frame appears briefly in the right bottom of the picture.

Each press switches the selection.

- 1 200 % size
- 2 400 % size
- 3 900 % size
- 4 normal size

- 2 Press the Cursor [◀/▶/▲/▼] keys to move through the zoomed picture.

- To resume normal playback, press the [ZOOM] or [CLEAR] key repeatedly.

Note:

Zoom may not work on some DVDs.

Time Search

To start playing at any chosen time on the disc.

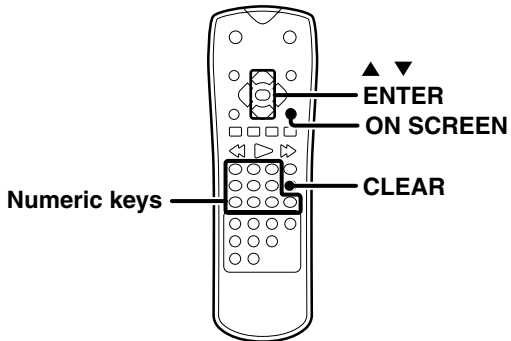

- 1** During playback, press the [ON SCREEN] key.
- 2** Press Cursor up/down [▲/▼] keys to select the time clock icon.



- "----:" appears.
- 3** Press Numeric keys to input the required start time in hours, minutes and seconds from left to right.
- If you enter the wrong numbers, press the [CLEAR] to remove the numbers you entered. Then input the correct numbers.
- 4** Press the [ENTER] key to confirm.
- Playback starts from the selected time.

Music disc playback

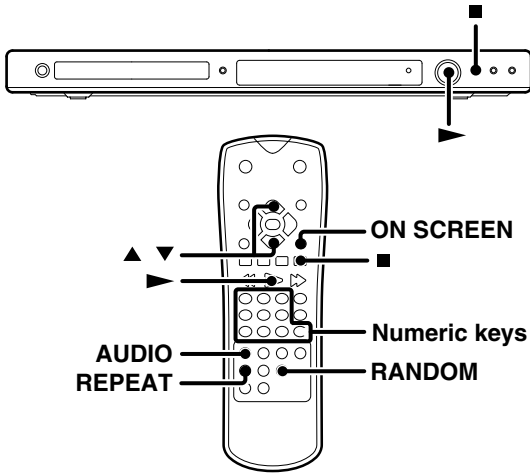

To display the ID3 tag

When playing a file containing information such as track titles, you can see the information by pressing [ON SCREEN] key.

Press the [ON SCREEN] key to display the ID3 tag.

- Song, Artist, Album, Comment and Genre display appears on the TV screen.

Each press switches the selection.

- ① Song
- ② Artist
- ③ Album
- ④ Comment
- ⑤ Genre
- ⑥ (File name)

- If there is no information, "No ID3 Tag Info" appear on the display.

Using the TV screen to start playback

Once you insert an audio CD, MP3 or WMA disc a menu appears on the TV screen.

Audio CD menu

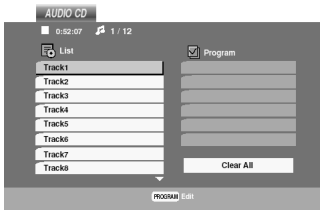

MP3/WMA menu

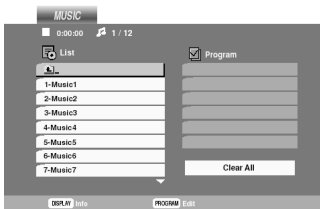

Press the Cursor up/down [▲/▼] keys to select a track then press the [▶] or [ENTER] and playback starts.

Playback from desired track

Press the numeric keys, then press the [▶] key.

To select track No. 2, 3 and ▶

Random play

The tracks of the disc are played in random order.

During playback, press the [RANDOM] key.

- The Random Play display appears on the TV screen.
- Each time you press the [RANDOM] key, random play would be on and off.
- By pressing [▶▶] key during random playback, the unit selects another track and resumes random playback.

To cancel random play

1 Press the [■] key to stop playback.

2 Press the [RANDOM] key to cancel random playback.

To repeat random play

During random playback, press the [REPEAT] key.

Each press switches the selection.

- ① "TRACK"
- ② "ALL"
- ③ Goes off (repeat off)

Note:

After all tracks of a disc have been played in random order, playback will stop.

Photo files playback (JPEG files only)

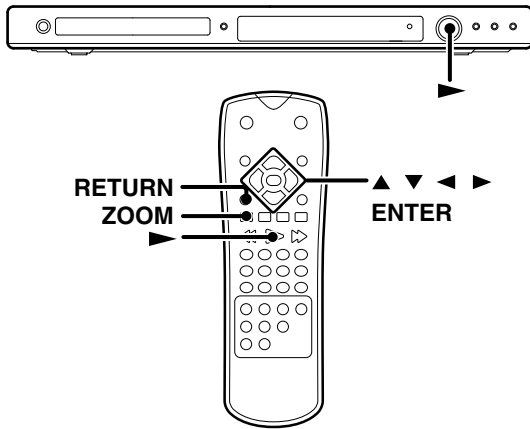

To rotate picture

Press the Cursor up/down [▲/▼] keys to rotate the picture clockwise or counter clockwise.

To hide the menu bar

Press the [RETURN] keys to hide the menu bar.

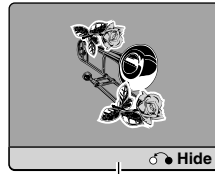

Menu bar

- Switching between display and no display is done each time the [RETURN] key is pressed.

Note:

When the resolution is set to 720p or 1080i, this function is not available.

Slide show

The Slide show function can be used to switch photo images automatically from one file to the next. There are 3 Slide speed options.

- 1 Insert a disc and close the tray.
- 2 Press Cursor [◀/▶/▲/▼] keys to highlight the speed icon
- 3 Press Cursor left/right [◀/▶] keys to select the option you want to use then press the [ENTER] key.

Each press switches the selection.

- 1 >>> : Fast
- 2 >> : Normal
- 3 > : Slow

- 4 Press Cursor up/down [▲/▼] keys to select the icon and then press the [ENTER] key.

- Playback starts.

To start playback

Once you insert an audio JPEG disc a menu appears on the TV screen.

- 1 Press the Cursor up/down [▲/▼] keys to select a folder then press the [ENTER] key.
- 2 A list of files in the folder appears. If you are in a file list and want to return to the previous Folder list, use the Cursor up/down [▲/▼] keys to highlight and press the [ENTER] key.
- 3 Select desired file, then press the [▶] or [ENTER] key.

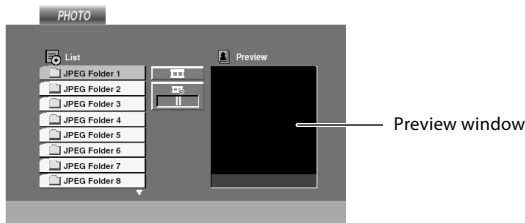

Zoom function

Use zoom to enlarge the photo image.

- 1 During playback, press the [ZOOM] key.
 - The square frame appears briefly in the right bottom of the picture.
 - Each press switches the selection.
 - 1 200 % size
 - 2 400 % size
 - 3 900 % size
 - 4 normal size
- 2 Press the Cursor [◀/▶/▲/▼] keys to move through the zoomed picture.
 - To resume normal playback, press the [ZOOM] or [CLEAR] key repeatedly.

Note:

When the resolution is set to 720p or 1080i, this function is not available.

Troubleshooting

Troubles are not always due to malfunction or failure of the system. In case of a trouble, check the following tales before calling for service.

Operation to reset

The microprocessor may fall into malfunction (impossibility to operate erroneous display, etc.) when the power cord is unplugged while power is ON or due to an external factor.

In this case, switch off the power, wait for several seconds, and then switch the power on again.

DVD player unit

Symptom	Remedy
The system cannot be switched ON.	<ul style="list-style-type: none"> When the power cord is plugged, wait for several seconds, and then switch the power on.
Playback does not start when the [▶] key is pressed.	<ul style="list-style-type: none"> Load a disc and press the [▶] key. There are no signals recorded on the side of the disc being played. Turn the disc over and properly place it on the disc tray.
Playback starts but no image/sound is seen heard.	<ul style="list-style-type: none"> Turn on the TV. Properly reconnect the connection cords. (See pages 11 - 13.)
The picture is disrupted when the image is fast forwarded or fast reversed.	<ul style="list-style-type: none"> The picture is slightly disrupted during fast forward and fast reverse operations. This is not a malfunction.
No sound is heard.	<ul style="list-style-type: none"> Properly connect the audio cords. (See pages 12.) Set the sound volume to an appropriate level. The player is in a special playback mode. Press the [▶] key to resume normal playback mode.
No picture is displayed.	<ul style="list-style-type: none"> Setting to progressive mode has been done for a TV not compatible with progressive mode. Press the [RESOLUTION] key to return to interlaced mode.
The picture does not look good or the picture/sound quality is poor.	<ul style="list-style-type: none"> A nearby device is generating noise. Separate this unit as far as possible from the device you think is generating the noise. Refer to the "Care and storage of disc" section and wipe dirt from the disc. (See page 10.) Refer to the "Be careful against condensation" section and evaporate the condensation. (See page 10.)
It takes a while for the disc to start playing.	<ul style="list-style-type: none"> Time is required for the unit to detect the disc type and size and for the rotation of the motor to stabilize. This is not a malfunction. Approximately 10 to 20 seconds are required for a disc to start playing, although the time differs depending on the disc.
The tray opens automatically.	<ul style="list-style-type: none"> Properly place the disc on the tray.
The top and bottom of the screen cannot be seen, or the screen becomes black-and-white.	<ul style="list-style-type: none"> Refer to the "Video formats" section, and use a disc with the appropriate video format for your TV or a TV with the appropriate video format for the disc. (See page 9.)
The subtitle is not displayed.	<ul style="list-style-type: none"> The subtitle cannot be displayed when the DVD disc being played does not contain the recording of subtitles. Press the [SUBTITLE] key to switch on the subtitle mode.
The voice (or subtitle) language cannot be changed.	<ul style="list-style-type: none"> The voice (or subtitle) language cannot be changed when the DVD disc being played does not contain the recording of more than one voice (or subtitle) language.
The viewing angle cannot be changed.	<ul style="list-style-type: none"> The viewing angle cannot be changed when the DVD disc being played does not contain the recording of more than one angle. More than one viewing angle may be recorded only in limited sections in a disc.
Playback will not start even after a title is selected.	<ul style="list-style-type: none"> Check the viewing restriction level (Rating) setting. (See page 18.)
The parental level cannot be changed.	<ul style="list-style-type: none"> You have forgotten the password. Set the initial setup to the factory setup with the following procedure. <ol style="list-style-type: none"> Press the [SETUP] key on the remote to display the Setup menu. Input the 6-digits number "210499" and the password is cleared. Enter a new code. (See page 18.)

Symptom	Remedy
The voice or subtitle language selected in the initial setting is not played.	<ul style="list-style-type: none"> • Use a DVD disc containing the recording of the selected voice or subtitle language. • Press the [SUBTITLE] or the [AUDIO] key on the remote and select the language. • The DVD specifications provide for selection at the menu screen. Select at the menu screen of the disc.
Menu screen messages are not shown in the desired language.	<ul style="list-style-type: none"> • Select disc menu language. (See page 17.)
A VCD cannot be played using menus.	<ul style="list-style-type: none"> • Menu playback is available only with VCD discs recorded with P.B.C.

Remote control unit

Symptom	Remedy
Remote control operation is not possible.	<ul style="list-style-type: none"> • Replace with new batteries. (See page 15.) • Operate the unit inside the remote controllable range. (See page 15.)

Inhibition icon

Symptom	Remedy
 The inhibition icon is displayed and remote control is not possible.	<ul style="list-style-type: none"> • Playback is restricted intentionally by the software producer. Please try another operation.

This product incorporates copyright protection technology that is protected by U.S. patents and other intellectual property rights. Use of this copyright protection technology must be authorized by Macrovision, and is intended for home and other limited viewing uses only unless otherwise authorized by Macrovision. Reverse engineering or disassembly is prohibited.

CONSUMERS SHOULD NOTE THAT NOT ALL HIGH DEFINITION TELEVISION SETS ARE FULLY COMPATIBLE WITH THIS PRODUCT AND MAY CAUSE ARTIFACTS TO BE DISPLAYED IN THE PICTURE. IN CASE OF 525 OR 625 PROGRESSIVE SCAN PICTURE PROBLEMS, IT IS RECOMMENDED THAT THE USER SWITCH THE CONNECTION TO THE "STANDARD DEFINITION" OUTPUT. IF THERE ARE QUESTIONS REGARDING OUR TV SET COMPATIBILITY WITH THIS MODEL 525P AND 625P DVD PLAYER, PLEASE CONTACT OUR CUSTOMER SERVICE CENTER.

Manufactured under license from Dolby Laboratories. "Dolby" and the double-D symbol are trademarks of Dolby Laboratories.

"DTS" and "DTS Digital Out" are registered trademarks of DTS, Inc. 

DivX, DivX Certified, and associated logos are trademarks of DivX, Inc. and are used under license.

HDMI, the HDMI logo and High-Definition Multimedia Interface are trademarks or registered trademarks of HDMI licensing LLC.

Specifications

[Type]

System.....DVD video player
Laser..... Semiconductor laser

[Audio Block]

Frequency response

Sampling frequency ; 44.1 kHz..... 8 Hz ~ 20 kHz
Sampling frequency ; 48 kHz..... 8 Hz ~ 22 kHz
Sampling frequency ; 96 kHz..... 8 Hz ~ 44 kHz

Signal to noise ratio More than 100 dB

Dynamic range.....More than 90 dB

Total harmonic distortionLess than 0.015 % (1 kHz)

Analog output level/impedance 2 V / 1 k Ω

Digital output level/impedance

COAXIAL 0.5 Vp-p / 75 Ω

OPTICAL.....-21 dBm ~ -15 dBm (Wave length 660 nm)

[Video Block]

Video output format

Europe and Australia..... NTSC/PAL

Except for Europe and Australia NTSC

Composite video output level 1 Vp-p (75 Ω)

S-video output level (Except for Europe)

(Y-signal) 1 Vp-p (75 Ω)

(C-signal)

NTSC..... 0.286 Vp-p (75 Ω)

PAL 0.300 Vp-p (75 Ω)

Component Video output level

(Y-signal) 1 Vp-p (75 Ω)

(CB-signal) 0.7 Vp-p (75 Ω)

(CR-signal) 0.7 Vp-p (75 Ω)

RGB output level (SCART) (For Europe) 0.7 Vp-p (75 Ω)

Horizontal resolution More than 500 lines

Video signal to noise ratio More than 68 dB

HDMI output terminal Type A (19 PIN)

[General]

Power consumption..... 8 W

Standby power consumptionLess than 0.8 W

Dimensions.....Width: 440 mm (17-5/16")

Height: 41 mm (1-5/8")

Depth: 204 mm (8-1/16")

Weight (net) 1.5 kg (3.3 lb)

- Design and specifications are subject to change without notice.
- Full performance is not guaranteed in extremely cold environments (under water-freezing temperatures).

KENWOOD

For your records

Record the serial number, found on the back of the unit, in the spaces designated on the warranty card, and in the space provided below. Refer to the model and serial numbers whenever you call upon your dealer for information or service on this product.

Model _____

Serial Number _____